

Biosafety in Microbiological and Biomedical Laboratories

6th Edition



Centers for Disease Control and Prevention
National Institutes of Health

Biosafety in Microbiological and Biomedical Laboratories

6th Edition



U.S. Department of Health and Human Services
Public Health Service
Centers for Disease Control and Prevention
National Institutes of Health

Revised June 2020

Foreword

Biosafety in Microbiological and Biomedical Laboratories (BMBL) has served as the cornerstone of biosafety practice in the United States since its initial release. We wish to emphasize that the sixth edition of BMBL remains an advisory document recommending best practices for the safe conduct of work in biomedical and clinical laboratories from a biosafety perspective. The BMBL is not intended to be a regulatory document although we recognize that some may use it in that way. The core principle of this document is protocol-driven risk assessment; it is not possible for a single document to identify all of the possible combinations of risks and mitigations feasible in biomedical and clinical laboratories. The BMBL should be used as a tool in the assessment and proposed mitigation steps in biomedical and clinical laboratories.

This edition of BMBL includes revised sections, agent summary statements, and appendices. We harmonized the recommendations included in this edition with guidance issued and regulations promulgated by other organizations and federal agencies. Wherever possible, we clarified both the language and intent of the information provided. In order to serve the needs of our community better, this edition includes new appendices on the following topics: inactivation and verification; laboratory sustainability; large-scale biosafety; and clinical laboratory biosafety.

Over 200 of our scientific and professional colleagues contributed to the preparation of the sixth edition through participation in technical working groups and serving as reviewers, guest editors, and subject matter experts. We wish to thank them all for their dedication and hard work. Without them, the sixth edition of BMBL would not be possible. We also recognize the hard work and contributions made by all who participated in preparation of the previous editions of BMBL; we have built on their solid work and commitment.

It would have been impossible to publish this revision without recognizing the visionary leadership of the previous BMBL editors—Drs. John Richardson, W. Emmett Barkley, Jonathan Richmond, Robert W. McKinney, Casey Chosewood, and Deborah Wilson—without whom the BMBL would not be the respected resource it is today. The Steering Committee members, Drs. Christy Myrick, Richard G. Baumann, Margy Lambert, Patricia Delarosa, and Theresa Lawrence, were instrumental in identifying authors, selecting additions to this edition, and reviewing submissions. Their significant contribution to this edition is sincerely appreciated.

We are truly grateful to Ms. Shaina Mangino and Dr. Mallory Pomales of Eagle Medical Services, LLC for their expertise and patience in assisting us with this undertaking. Their superb organizational and editing skills were critical in the creation of this document.

We hope you find the sixth edition of *Biosafety in Microbiological and Biomedical Laboratories* complete, timely, and most of all, easy to use. Thank you for your patience and understanding during the long and comprehensive revision process.

Paul J. Meechan, PhD, MPH, RBP, CBSP(ABSA)
Associate Director for Laboratory Safety
Office of Laboratory Science and Safety
Centers for Disease Control and Prevention
Atlanta, GA

Jeffrey Potts, MPH, CBSP(ABSA)
Chief, Biorisk Management Branch
Division of Occupational Health and Safety
National Institutes of Health
Bethesda, MD

Participants

Senior Co-Editors

Paul J. Meechan, PhD, MPH, RBP, CBSP(ABSA)
Associate Director for Laboratory Safety
Office of Laboratory Science and Safety
Centers for Disease Control and Prevention

Jeffrey Potts, MPH, CBSP(ABSA)
Chief, Biorisk Management Branch
Division of Occupational Health and Safety
National Institutes of Health

Steering Committee

Richard G. Baumann, PhD, SM(NRCM)
Biological Safety Officer
Division of Occupational Health and Safety
National Institutes of Health

Patricia Delarosa, PhD, CBSP(ABSA), CTM(ATAP)
Health Scientist, Biosafety
Office of Strategy, Policy, Planning, and Requirements
Office of the Assistant Secretary for Preparedness and Response
Department of Health and Human Services

Margy Lambert, PhD
Health Scientist
Office of Science and Technology Assessment
Occupational Safety and Health Administration

CAPT Theresa Lawrence, PhD
Senior Science Officer
Office of the Associate Director for Preparedness and Response
U.S. Department of Health and Human Services

Paul J. Meechan, PhD, MPH, RBP, CBSP(ABSA)
Associate Director for Laboratory Safety
Office of Laboratory Science and Safety
Centers for Disease Control and Prevention

Christy Myrick, PhD, RBP(ABSA)
Lead Auditor
U.S. National Authority for Containment for Polioviruses
Center for Preparedness and Response
Centers for Disease Control and Prevention

Jeffrey Potts, MPH, CBSP(ABSA)
Chief, Biorisk Management Branch
Division of Occupational Health and Safety
National Institutes of Health

Deborah E. Wilson, DrPH, CBSP(ABSA)
RADM (ret.), U.S. Public Health Service,
Division of Occupational Health and Safety—Director
Office of Research Services
National Institutes of Health

Technical Editors

Shaina Mangino
Senior Publications Editor
Eagle Medical Services, LLC

Mallory J. Pomales, DO
Senior Program Manager for Scientific Writers
Senior Scientific Editor
Eagle Medical Services, LLC

Primary Authors

Matthew J. Arduino, MS, DrPH, FSHEA, M(ASCP)CM
Sr. Adviser, Environmental Hygiene and Infection Prevention
Office of the Director
Division of Healthcare Quality Promotion
Centers for Disease Control and Prevention

William D. Arndt
Health Scientist—Biorisk
Division of Laboratory Systems
Centers for Disease Control and Prevention

Heike Bailin, MD
Staff Physician, Occupational Medical Service
Division of Occupational Health and Safety
National Institutes of Health

Richard G. Baumann, PhD, SM(NRCM)
Biological Safety Officer
Division of Occupational Health and Safety
National Institutes of Health

Richard S. Bradbury, PhD, FFSc RCPA
Division of Parasitic Diseases and Malaria
Center for Global Health
Centers for Disease Control and Prevention

Mary E. Brandt, PhD
Office of Laboratory Science and Safety
Centers for Disease Control and Prevention

Cristina Bressler, MBA
Health Scientist
Occupational Health and Safety Office
Office of Safety, Security and Asset Management
Centers for Disease Control and Prevention

Byron Caughey, PhD
Senior Investigator
Laboratory of Persistent Viral Diseases, Rocky Mountain Laboratories
National Institute for Allergy and Infectious Diseases
National Institutes of Health

Rear Admiral Terri R. Clark, DVM, DACLAM
Director (ret.), Office of Animal Care and Use
Assistant Surgeon General
USPHS Commission Corps
National Institutes of Health

Danielle Daniely, PhD, RBP(ABSA)
Director, Research Safety Programs and High Containment Laboratories
Office of Research Integrity
Georgia State University

Patricia Delarosa, PhD, CBSP(ABSA), CTM(ATAP)
Health Scientist, Biosafety
Office of Strategy, Policy, Planning, and Requirements
Office of the Assistant Secretary for Preparedness and Response
Department of Health and Human Services

Stephen Denny, DVM, MS, DAACLAM, DACVPM
Acting Director, Office of Animal Care and Use
Office of Intramural Research
National Institutes of Health

Eileen Edmonson
Transportation Regulations Specialist
Standards and Rulemaking Division
Pipeline and Hazardous Materials Safety Administration
U.S. Department of Transportation

Samuel S. Edwin, PhD
Director
Division of Select Agents and Toxins
Center for Preparedness and Response
Centers for Disease Control and Prevention

Elizabeth (Zeba) Floyd, AIA, LEED AP BD+C ID+C
Project Director
Sustainable Design Consulting, LLC

Karen M. Frank, MD, PhD, D(ABMM)
Chief, Department of Laboratory Medicine
Clinical Center
National Institutes of Health

Mark D. Gibson, MS, CIH
Senior Industrial Hygienist
Division of Occupational Health and Safety
National Institutes of Health

Eduardo Gomez-Saladin, PhD, SM, RBP, CBSP(ABSA)
Deputy Director
Office of Laboratory Safety
Centers for Disease Control and Prevention

Natasha K. Griffith, MS
Chief, Quality and Safety Systems Branch
Division of Laboratory Systems
Centers for Disease Control and Prevention

Ted Hackstadt, PhD
Chief, Host-Parasite Interactions Section
Laboratory of Bacteriology
Rocky Mountain Laboratories
National Institute for Allergy and Infectious Diseases
National Institutes of Health

Susan B. Harper, DVM, MS, DACLAM, DACVPM, RBP(ABSA)
Office of National Programs
USDA Agricultural Research Service

Kathryn L. Harris PhD, RBP(ABSA)
Senior Outreach and Education Specialist
Biosafety, Biosecurity and Emerging Biotechnology Policy Division
Office of Science Policy
National Institutes of Health

Mark L. Hemphill, MS
Deputy Director, Division of Select Agents and Toxins
Center for Preparedness and Response
Centers for Disease Control and Prevention

Barbara L. Herwaldt, MD, MPH
Medical Epidemiologist, Division of Parasitic Diseases and Malaria
Centers for Disease Control and Prevention

Nancy P. Hoe, PhD, CBSP(ABSA)
Biosafety Officer/Responsible Official for Rocky Mountain Laboratories
Division of Occupational Health and Safety
Office of the Director, National Institutes of Health

Joseph P. Kozlovac, MS, RBP, CBSP(ABSA), SM(NRCM)
Agency Biosafety Officer
USDA Agricultural Research Service
Office of National Programs

Margy Lambert, PhD
Health Scientist
Office of Science and Technology Assessment
Occupational Safety and Health Administration

George W. Lathrop
Veterinary Medical Officer
National Center for Emerging and Zoonotic Infectious Diseases
Centers for Disease Control and Prevention

Susan Lawrence, PhD
Branch Chief
Microbiology Branch
Environmental Protection Agency

Susan A. Lippold, MD, MPH
Medical Director
Occupational Health Clinic
Centers for Disease Control and Prevention

R. Trevor Lubbert
Board Certified Senior Staff Entomologist
Community Health Branch
Division of Occupational Health and Safety
Office of Research Safety
National Institutes of Health

Carolina Lúquez, PhD
National Botulism and Enteric Toxins Team
Enteric Diseases Laboratory Branch
Division of Foodborne, Waterborne, and Environmental Diseases
National Center for Emerging and Zoonotic Infectious Diseases
Centers for Disease Control and Prevention

Patrick M. McNutt, PhD
Principal Investigator
Department of Neuroscience
U.S. Army Medical Research Institute of Chemical Defense

Paul J. Meechan, PhD, MPH, RBP, CBSP(ABSA)
Associate Director for Laboratory Safety
Office of Laboratory Science and Safety
Centers for Disease Control and Prevention

Barbara Owen, MPH, CBSP(ABSA), RBP, NRCM, CMM
Director, Global Safety and Environment
Corporate Biosafety Officer
Merck & Co., Inc.

Steven Piguet, AIA, LEED Fellow, Fitwel Ambassador
Associate Principal
Sustainable Design Consulting, LLC

Segaran P. Pillai, PhD, SM(NRCM), SM(ASCP), FAAM
Director, Office of Laboratory Science and Safety
Office of the Commissioner
Food and Drug Administration

Jeffrey Potts, MPH, CBSP(ABSA)
Chief, Biorisk Management Branch
Division of Occupational Health and Safety
National Institutes of Health

Nathaniel Powell Jr., DVM, MS
Chief, Comparative Medicine Branch
Division of Scientific Resources
National Center for Emerging and Zoonotic Infectious Diseases
Centers for Disease Control and Prevention

Ann M. Powers, PhD
Lead, Virology Team
Arboviral Diseases Branch
Division of Vector-Borne Diseases
Centers for Disease Control and Prevention

Reynolds M. Salerno, PhD
Director, Division of Laboratory Systems
Centers for Disease Control and Prevention

Dr. Martin L. Sanders, PhD, CSP
Director, Safety, Emergency, and Environmental Compliance
Department of Health and Human Services

James M. Schmitt, MD, MS
Medical Director
Occupational Medical Service
Division of Occupational Health and Safety
National Institutes of Health

Stephen Tomasino, PhD
Senior Scientist
Environmental Protection Agency

Elizabeth G. Weirich, MS, SM(NRCM), CBSP(ABSA)
Division of Laboratory Systems
Centers for Disease Control and Prevention

David M. White, DVM, PhD, RBP(ABSA), DACVM
Safety & Security Unit Lead
National Centers for Animal Health
USDA Animal and Plant Health Inspection Service

Deborah E. Wilson, DrPH, CBSP(ABSA)
RADM (ret.), U.S. Public Health Service,
Division of Occupational Health and Safety—Director
Office of Research Services
National Institutes of Health

Liz E. York, FAIA
Chief Sustainability Officer
Office of the Chief Operating Officer
Centers for Disease Control and Prevention

Contributors

Michael Adler	Edward Dubovi	Crystal Johnson
Karen Anderson	Eilyn Fabregas	Eric A. Johnson
Rebecca V. Anderson	Chadi Filfli	Julie Johnson
Matthew J. Arduino	Betty A. Forbes	Estella Z. Jones
David Asher	Marshall Gayton	Joanne Jones-Meehan
John Balog	Sarah Genzer	Gerardo Kaplan
Shawn A. Bean	Christopher Good	Subhashinie
David E. Bentzel	Andrew Haddow	Kariyawasam
Cary R. Binder	Vibeke (Vips)	Jaqueline Katz
Brad Blitvich	Halkjaer-Knudsen	Arifa Khan
Kathryn Board	Alexander Hamberg	Lydia Kibiuk
William P. Bozza	Glen Hansen	Chris Kiley
Megan Morgan Brose	David Harbourt	Manley Kiser
Robert Bull	Kathryn L. Harris	Rajen Koshy
Cara Burns	Courtney Harrison	Laura Kramer
Sheldon Campbell	Michael W. Hart	Philip Krause
Cynthia Cary	Robert Hawley	Jens Kuhn
Nick Chaplinski	Henry Hays	Anna Llewellyn
Mark Chappell	John Henneman	Maria Lorenzo
Konstantin Chumakov	Stephen Higgs	Luis Lugo-Roman
Jeffrey Cohen	Julia Hilliard	Nicole Lukovsky-
Eugene Cole	Michael Holbrook	Akhsanov
Nancy Cornish	Bill Homovec	Marian Major
Whitni Davidson	Romney Humphries	Monear Makvandi
C. Todd Davis	Debra Hunt	Alison Mawle
Sabrina Debose	Freeda Isaac	Erin McElvania
Johnathan R. Deeds	Eddie L. Jackson	Thomas A. McKeon
Thomas Denagamage	Peter Jahrling	David Scott McVey
Beverly Dickson	Robert Jambou	Thomas P. Monath
Gerhard Dobler	Eric Jeppesen	Rashida Moore
Mike Drebot	Barbara Johnson	David Morens
		Eric C. Mossel

Krista Murray	Lawrence B. Schonberger	Diana Whipple
Christy Myrick	Lynne M. Sehulster	Temeri Wilder-Kofie
Brandy Nelson	Brianna Skinner	Axel Wolff
Joseph Newsome	Halley Smith	Zhiping Ye
Stuart Nichol	James Synder	Kyoung-Jin Yoon
Kenneth E. Nusbaum	Marisa Elkins St. Claire	Edward You
Steve Oberste	James Stevens	Jessica Young
Patricia Olinger	Molly Stitt-Fischer	Baolin Zhang
Lillian Orciari	James R. Swearngen	
Eugene O'Reilly	William M. Switzer	
Mark Pagala	Sandra Tallent	
Subbian Satheshkumar (Sathesh) Panayampalli	Cassandra Tansey	
Eun-Chung Park	Robert Tesh	
Amar Patil	Anil J. Thachil	
Michael A. Pentella	Eileen L. Thacker	
William Peters	Natalie J. Thornburg	
Brett Petersen	William H. Tolleson	
Brian R. Petuch	John Tonkiss	
Susan C. Piguet	Althea C. Treacy	
Ewan Plant	Anita Trichel	
Kristin Prentice	Jessica Tucker	
Suzette Priola	Terrence Tumpey	
Amy Pullman	Timothy Uyeki	
Richard Rebar	Francisco A. Uzal	
Yvonne Reed	Nikos Vasilakis	
Ryan F. Relich	Linfa (Lin-Fa) Wang	
Pierre Rollin	David Warnock	
Eugene Rosenthal	Scott Weaver	
Scott Rusk	Zachary Weiner	
Janice Rusnak	Rebecca Weingarten	
Arick P. Sabin	Robbin Weyant	
Mo D. Salman	Mark Whary	

Contents

Foreword	iii
Participants	v
Senior Co-Editors.....	v
Steering Committee	v
Technical Editors.....	vi
Primary Authors	vi
Section I—Introduction	1
The Occurrence of Laboratory-associated infections	1
Evolution of National Biosafety Guidelines.....	3
Risk Criteria for Establishing Ascending Levels of Containment	4
Agent Summary Statements	5
Laboratory Biosecurity	6
Using <i>Biosafety in Microbiological and Biomedical Laboratories</i>	6
Looking Ahead	7
References	7
Section II—Biological Risk Assessment	9
The Risk Management Process	10
Risk Communication	19
Facilitating a Culture of Safety through Risk Assessment	19
Conclusion	20
References	20
Section III—Principles of Biosafety	24
Safety Equipment (Primary Barriers).....	24
Personal Protective Equipment.....	25
Facility Design and Construction (Secondary Barriers).....	25
Facility Practices and Procedures	26
Biosafety Levels.....	27
Animal Facilities	30
Clinical Laboratories	30
Laboratory Biosecurity	31
References	31
Section IV—Laboratory Biosafety Level Criteria	32
Biosafety Level 1.....	32
A. Standard Microbiological Practices	32
B. Special Practices	36

C. Safety Equipment (Primary Barriers and Personal Protective Equipment)	36
D. Laboratory Facilities (Secondary Barriers).....	36
Biosafety Level 2.....	37
A. Standard Microbiological Practices.....	37
B. Special Practices	40
C. Safety Equipment (Primary Barriers and Personal Protective Equipment).....	41
D. Laboratory Facilities (Secondary Barriers).....	42
Biosafety Level 3.....	43
A. Standard Microbiological Practices.....	43
B. Special Practices	46
C. Safety Equipment (Primary Barriers and Personal Protective Equipment).....	48
D. Laboratory Facilities (Secondary Barriers).....	48
Biosafety Level 4.....	51
A. Standard Microbiological Practices.....	52
B. Special Practices	55
C. Safety Equipment (Primary Barriers and Personal Protective Equipment).....	57
D. Laboratory Facilities (Secondary Barriers).....	59
Section V—Vertebrate Animal Biosafety Level Criteria for Vivarium Research Facilities.....	70
Animal Biosafety Level 1	71
A. Standard Microbiological Practices.....	72
B. Special Practices	76
C. Safety Equipment (Primary Barriers and Personal Protective Equipment)	76
D. Animal Facilities (Secondary Barriers).....	76
Animal Biosafety Level 2.....	78
A. Standard Microbiological Practices.....	78
B. Special Practices	82
C. Safety Equipment (Primary Barriers and Personal Protective Equipment).....	83
D. Animal Facilities (Secondary Barriers).....	84
Animal Biosafety Level 3.....	87
A. Standard Microbiological Practices.....	87
B. Special Practices	91

C. Safety Equipment (Primary Barriers and Personal Protective Equipment).....	93
D. Animal Facilities (Secondary Barriers).....	94
Animal Biosafety Level 4.....	98
A. Standard Microbiological Practices.....	98
B. Special Practices.....	102
C. Safety Equipment (Primary Barriers and Personal Protective Equipment).....	104
D. Animal Facilities (Secondary Barriers).....	108
References.....	117
Section VI—Principles of Laboratory Biosecurity.....	119
Biosafety and Laboratory Biosecurity.....	120
Developing a Laboratory Biosecurity Program.....	122
Example Guidance: A Laboratory Biosecurity Risk Assessment and Management Process.....	123
Elements of a Laboratory Biosecurity Program.....	124
References.....	128
Section VII—Occupational Health Support for Biomedical Research.....	130
Framework for Occupational Health Support of Biomedical Research.....	130
Elements of an Occupational Health Program Supporting Biomedical Research.....	133
Conclusion.....	141
References.....	141
Section VIII—Agent Summary Statements.....	147
References.....	147
Section VIII-A: Bacterial Agents.....	148
<i>Bacillus anthracis</i>	148
<i>Bordetella pertussis</i>	150
<i>Brucella</i> species.....	152
<i>Burkholderia mallei</i>	154
<i>Burkholderia pseudomallei</i>	156
<i>Campylobacter</i> species.....	157
<i>Chlamydia psittaci</i> , <i>C. trachomatis</i> , <i>C. pneumoniae</i>	158
<i>Clostridium botulinum</i> and neurotoxin-producing species of Clostridia.....	161
<i>Clostridioides</i> (formerly <i>Clostridium</i>) <i>difficile</i>	162

<i>Clostridium tetani</i> and Tetanus toxin	163
<i>Corynebacterium diphtheriae</i>	164
<i>Francisella tularensis</i>	165
<i>Helicobacter</i> species	167
<i>Legionella pneumophila</i> and other <i>Legionella</i> spp.	168
Leptospira	169
<i>Listeria monocytogenes</i>	171
<i>Mycobacterium leprae</i>	172
<i>Mycobacterium tuberculosis</i> complex	173
<i>Mycobacterium</i> spp. other than <i>M. tuberculosis</i> complex and <i>M. leprae</i>	175
<i>Neisseria gonorrhoeae</i>	177
<i>Neisseria meningitidis</i>	178
<i>Salmonella</i> serotypes, other than <i>S. enterica</i> serotype Typhi (<i>S. Typhi</i>)	179
<i>Salmonella enterica</i> serotype Typhi (<i>S. Typhi</i>)	181
Shiga toxin (Verocytotoxin)-producing <i>Escherichia coli</i>	182
<i>Shigella</i>	184
<i>Staphylococcus aureus</i> (Methicillin-Resistant, Vancomycin- Resistant, or Vancomycin-Intermediate).....	185
<i>Treponema pallidum</i>	187
<i>Vibrio</i> species	188
<i>Yersinia pestis</i>	189
References	191
Section VIII-B: Fungal Agents	212
<i>Blastomyces dermatitidis</i> and <i>Blastomyces gilchristii</i>	212
<i>Coccidioides immitis</i> and <i>Coccidioides posadasii</i>	213
<i>Histoplasma capsulatum</i>	215
<i>Sporothrix schenckii</i> species complex.....	216
Miscellaneous Yeast and mold organisms causing human infection	217
References	219
Section VIII-C: Parasitic Agents	223
General Issues.....	223
Blood and Tissue Protozoal Parasites.....	223
Intestinal Protozoal Parasites.....	228

Cestode Parasites.....	230
Trematode Parasites.....	232
Nematode Parasites	233
References	237
Section VIII-D: Rickettsial Agents.....	239
<i>Coxiella burnetii</i>	239
<i>Rickettsia</i> species and <i>Orientia tsutsugamushi</i>	241
References	244
Section VIII-E: Viral Agents	247
Hantaviruses.....	247
Hendra Virus (formerly known as Equine Morbillivirus) and Nipah Virus.....	248
Hepatitis A Virus, Hepatitis E Virus.....	250
Hepatitis B Virus, Hepatitis C Virus, Hepatitis D Virus.....	251
<i>Macacine alphaherpevirus</i> 1 (Herpesvirus Simiae, Cercopithecine herpesvirus I, Herpes B Virus).....	253
Human Herpes Virus.....	256
Influenza Viruses	259
Lymphocytic Choriomeningitis Virus.....	264
Poliovirus	265
Poxviruses	268
Rabies Virus and related lyssaviruses	271
Retroviruses, including Human and Simian Immunodeficiency Viruses (HIV and SIV)	273
Severe Acute Respiratory Syndrome (SARS) and Middle East Respiratory Syndrome (MERS) Coronaviruses	276
References	280
Section VIII-F: Arboviruses and Related Zoonotic Viruses.....	292
Risk Group 2 Viruses with BSL-2 Containment Recommended	294
Risk Group 3 Viruses with BSL-3 Containment Recommended	295
West Nile Virus (WNV).....	300
Eastern Equine Encephalitis Virus (EEEV), Venezuelan Equine Encephalitis Virus (VEEV), and Western Equine Encephalitis Virus (WEEV)	302
Rift Valley Fever Virus (RVFV).....	304
References	330

Section VIII-G: Toxin Agents	334
Botulinum Neurotoxin.....	334
Staphylococcal Enterotoxins (SE).....	337
Ricin.....	340
Selected Low Molecular Weight (LMW) Toxins	343
References	347
Section VIII-H: Prion Diseases	355
Bovine Spongiform Encephalopathy	360
Handling and processing of tissues from patients with suspected prion disease	361
Handling and processing of multiple human prion tissue samples	361
References	363
Appendix A—Primary Containment for Biohazards: Selection, Installation, and Use of Biological Safety Cabinets	367
Part 1—Introduction	367
Part 2—High-Efficiency Particulate Air (HEPA) Filters and the Development of Biological Containment Devices	368
Part 3—Biological Safety Cabinets	370
Part 4—Other Laboratory Hazards and Risk Assessment.....	376
Part 5—BSC Use by the Investigator: Work Practices and Procedures	378
Part 6—Facility and Engineering Requirements.....	384
Part 7—Certification of BSCs.....	386
Acknowledgments.....	396
References	397
Appendix B—Decontamination and Disinfection of Laboratory Surfaces and Items	400
Purpose and Scope	400
Antimicrobial Products—U.S. Regulations	400
Environmentally-Mediated Transmission of Infection	401
Principles of Cleaning, Disinfection, and Sterilization.....	401
Decontamination	403
References	410
Appendix C—Transportation of Infectious Substances.....	415
International Harmonization of Shipping and Transport Regulations.....	415
Transportation Regulations	415
Select Agents.....	416
Regulations	416

Importation and Transfers	417
Transfer of USDA Plant Pests	418
DOT Packaging of Infectious Substances	418
Intrafacility Specimen and Sample Transfers	421
References	421
Appendix D—Biosafety and Biocontainment for Pathogens Affecting Agricultural Animals and Animals that are Loose-Housed or in Open Penning	423
Introduction	423
Potential Enhancements for BSL-2 and ABSL-2 Facilities for Conducting Work with Pathogens Affecting Agricultural Animals	426
Potential Enhancements for BSL-3 and ABSL-3 Facilities for Conducting Work with Pathogens Affecting Agricultural Animals	427
BSL-4 and ABSL-4 Facilities that Work with Pathogens Affecting Agricultural Animals	429
Potential Enhancements for Animal Biosafety Level 2-Agriculture (ABSL-2Ag) Facilities for Conducting Work with Animals that are Loose-Housed or in Open Penning.....	429
Animal Biosafety Level 3-Agriculture (ABSL-3Ag) Facilities required for activities involving the use of hazardous biological agents designated as High-Consequence Foreign Animal Diseases and Pests by USDA APHIS in animals that are loose-housed or in open penning.....	433
Animal Biosafety Level 4-Agriculture (ABSL-4Ag) Facilities for Conducting Work with Animals that are Loose-Housed or in Open Penning	443
References	456
Appendix E—Arthropod Containment Guidelines (ACG)	458
References	459
Appendix F—Select Agents and Toxins	460
Appendix G—Integrated Pest Management (IPM)	463
References	465
Appendix H—Working with Human, Non-Human Primate (NHP), and Other Mammalian Cells and Tissues.....	466
Bloodborne pathogens and risk assessment related to material source and type.....	466
Risk Mitigation	468
References	468

Appendix I—Guidelines for Work with Toxins of Biological Origin	470
General Considerations for Toxin Use.....	470
Training and Laboratory Planning	471
Safety Equipment and Containment.....	472
Inadvertent Toxin Aerosols	473
Mechanical Injuries	474
Additional Precautions	475
Decontamination and Spills.....	476
Select Toxins.....	478
References	481
Appendix J—NIH Oversight of Research Involving Recombinant Biosafety Issues.....	484
Appendix K—Inactivation and Verification	486
Background.....	486
Filtration and Centrifugation	487
Development of Inactivation Procedures.....	487
Validation of Inactivation Procedures	495
Alternative Strategies	495
Attenuation Methods	496
Process Verification	498
Institutional Verification	498
Tracking of and Communication about Inactivated Samples.....	498
Ongoing Review and Oversight of Inactivation and Verification Procedures	499
Other Important Considerations	500
Conclusion	500
References	501
Appendix L—Sustainability.....	504
Introduction and Issues.....	504
Strategies for Existing Laboratories and Operations	504
Strategies for New and Renovated Laboratories.....	507
References	512
Appendix M—Large-Scale Biosafety	515
Introduction	515
Risk Assessment.....	515
Conclusion	526
References	526

Appendix N—Clinical Laboratories	529
Clinical Laboratory Biosafety.....	529
Conducting Risk Assessments in a Clinical Laboratory Environment.....	529
Implementing Mitigation Measures in the Clinical Laboratory Environment	531
Challenges in a Clinical Laboratory Environment.....	537
Implementing Performance Management in a Clinical Laboratory Environment	539
Risk Ethics in a Clinical Laboratory Environment.....	540
Summary	541
References	541
Appendix O—Acronyms	544
Glossary	552
Index	559
Accessibility Descriptions of Figures	571
Appendix A—Primary Containment for Biohazards	571
Appendix C—Transportation of Infectious Substances	574

Tables

Section IV—Laboratory Biosafety Level Criteria

[Table 1. Summary of Laboratory Biosafety Levels \(BSLs\)](#)

Section VIII-B: Fungal Agents

[Table 1. Miscellaneous Yeast and Mold](#)

Section VIII-E: Viral Agents

[Table 1. Viruses currently included in the genus *Lyssavirus*](#)

Section VIII-F: Arboviruses and Related Zoonotic Viruses

[Table 1. Vaccine Strains of Specific Viruses that May Be Handled at BSL-2](#)

[Table 2. Explanation of Symbols Used in Tables 3 and 4 to Define Basis for Assignment of Viruses to Biosafety Levels](#)

[Table 3. Alphabetic Listing of Arboviruses and Hemorrhagic Fever Viruses*](#)

[Table 4. Alphabetic Listing of Arboviruses and Hemorrhagic Fever Viruses*](#)

[Table 5. Laboratories working with the viruses at BSL-3 listed below are recommended to HEPA filter the exhaust air](#)

Section VIII-H: Prion Diseases

[Table 1. Human Prion Diseases](#)

[Table 2. Animal Prion Diseases](#)

[Table 3. Tissue Preparation for Human CJD and Related Diseases](#)

[Table 4. Prion Inactivation Methods for Reusable Instruments and Surfaces](#)

Appendix A—Primary Containment for Biohazards: Selection, Installation, and Use of Biological Safety Cabinets

[Table 1. Selection of a Safety Cabinet through Risk Assessment](#)

[Table 2. Comparison of Biosafety Cabinet Characteristics](#)

Appendix B—Decontamination and Disinfection of Laboratory Surfaces and Items

[Table 1. Activity Levels of Selected Liquid Chemical Disinfectants](#)

Appendix D—Biosafety and Biocontainment for Pathogens Affecting Agricultural Animals and Animals that are Loose-Housed or in Open Penning

[Table 1. Bacteria](#)

[Table 2. Fungi and Molds](#)

[Table 3. Nematodes, Trematodes, Cestodes, Protozoa, and Ectoparasites](#)

[Table 4. Viruses](#)

[Table 5. Toxins](#)

[Table 6. Prions](#)

[Table Key 1. Natural Host Range](#)

[Table Key 2. Natural Routes of Transmission](#)

[Table Key 3. Environmental Stability](#)

Appendix I—Guidelines for Work with Toxins of Biological Origin

[Table 1. Physical Inactivation of Toxins](#)

[Table 2. Chemical Inactivation of Toxins](#)

Appendix K—Inactivation and Verification

[Table 1. Advantages of Physical Inactivation](#)

[Table 2. Disadvantages of physical inactivation](#)

[Table 3. Advantages of chemical inactivation](#)

[Table 4. Disadvantages of chemical inactivation](#)

[Table 5. Advantages of chemical activated by physical treatment](#)

[Table 6. Disadvantages of chemical activated by physical treatment](#)

[Table 7. Advantages of natural and emerging antimicrobial strategies](#)

[Table 8. Disadvantages of natural and emerging antimicrobial strategies](#)

[Table 9. Advantages of combination methods](#)

[Table 10. Disadvantages of combination methods](#)

[Table 11. Advantages of novel methods to attenuate pathogens](#)

[Table 12. Disadvantages of novel methods to attenuate pathogens](#)

Figures

Appendix A—Primary Containment for Biohazards: Selection, Installation, and Use of Biological Safety Cabinets

[Figure 1. HEPA Filters](#)

[Figure 2. The Class I BSC](#)

[Figure 3. The Class II, Type A BSC](#)

[Figure 4. Canopy \(thimble\) unit for ducting a Class II, Type A BSC](#)

[Figure 5a. The Class II, Type B1 BSC \(classic design\)](#)

[Figure 5b. The Class II, Type B1 BSC \(benchttop design\)](#)

[Figure 6. The Class II, Type B2 BSC](#)

[Figure 7a. The Class II, Type C1 BSC \(not connected to building exhaust system\)](#)

[Figure 7b. The Class II, Type C1 BSC \(connected to building exhaust system\)](#)

[Figure 8. The Class III BSC](#)

[Figure 9a. The Horizontal Laminar flow Clean Bench](#)

[Figure 9b. The Vertical Laminar Flow Clean Bench](#)

[Figure 10. Clean to Dirty](#)

[Figure 11. Protection of a house vacuum](#)

[Figure 12. Bag-in/bag-out filter enclosure](#)

Appendix B—Decontamination and Disinfection of Laboratory Surfaces and Items

[Figure 1. Descending Order of Relative Resistance to Disinfectant Chemicals](#)

Appendix C—Transportation of Infectious Substances

[Figure 1. A Category A UN Standard Triple Packaging](#)

[Figure 2. A Category B Non-specification Triple Packaging](#)

Section I—Introduction

Biosafety in Microbiological and Biomedical Laboratories (BMBL) has become the overarching guidance document for the practice of biosafety in the U.S.—the mechanism for addressing the safe handling and containment of infectious microorganisms and hazardous biological materials. The principles of biosafety introduced in 1984 in the first edition of BMBL¹ and carried through this edition remain steadfast. These principles are containment and risk assessment. The fundamentals of containment include the microbiological practices, safety equipment, and facility safeguards that protect laboratory workers, the environment, and the public from exposure to infectious microorganisms that are handled and stored in the laboratory. Risk assessment is the process that enables the appropriate selection of microbiological practices, safety equipment, and facility safeguards that can help prevent Laboratory-associated infections (LAI). The purpose of periodic updates of BMBL is to refine guidance based on new knowledge and experiences and to address contemporary issues that present new risks that confront laboratory workers and the public health. In this way, the guidance provided within the BMBL will continue to serve the microbiological and biomedical community as a relevant and valuable reference.

The uncertainty and change regarding the identification of emerging agents and the requirements for containment and safe storage of pathogens continues to accelerate since the last edition of the BMBL was published. New infectious agents and diseases have emerged. Work with infectious agents in public and private research, public health, clinical and diagnostic laboratories, and in animal care facilities has expanded. World events have demonstrated new threats of bioterrorism. For these reasons, organizations and laboratory directors are compelled to evaluate and ensure the effectiveness of their biosafety programs, the proficiency of their workers, as well as the capability of equipment, facilities, and management practices to provide containment and security of microbiological agents. Similarly, individual workers who handle pathogenic microorganisms must understand the containment conditions under which infectious agents can be safely manipulated and secured. Application of this knowledge and the use of appropriate techniques and equipment will enable the microbiological and biomedical community to help prevent personal, laboratory, and environmental exposure to potentially infectious agents or biohazards.

The Occurrence of Laboratory-associated infections

Published reports of LAIs first appeared around the start of the 20th century. By 1978, four studies by Pike and Sulkin collectively identified 4,079 LAIs resulting in 168 deaths occurring between 1930 and 1978.²⁻⁵ These studies found that the ten most common causative agents of overt infections among workers were *Brucella* spp., *Coxiella burnetii*, hepatitis B virus (HBV), *Salmonella enterica* serotype Typhi, *Francisella tularensis*, *Mycobacterium tuberculosis*, *Blastomyces*

dermatitidis, Venezuelan equine encephalitis virus, *Chlamydia psittaci*, and *Coccidioides immitis*. The authors acknowledged that the 4,079 cases did not represent all LAIs that occurred during this period, since many laboratories chose not to report overt cases or conduct surveillance programs to identify subclinical or asymptomatic infections.

In addition, historical reports of LAIs seldom provided data sufficient to determine incidence rates, complicating quantitative assessments of risk. Similarly, there were no distinguishable accidents or exposure events identified in more than 80% of the LAIs reported before 1978. Studies did show that, in many cases, the infected person worked with a microbiological agent or was in the vicinity of another person handling an agent.²⁻⁶

During the 20 years following the Pike and Sulkin publications, a worldwide literature search by Harding and Byers revealed 1,267 overt infections with 22 deaths.⁷ Five deaths were of fetuses aborted as the consequence of a maternal LAI. *Mycobacterium tuberculosis*, *Coxiella burnetii*, hantavirus, arboviruses, HBV, *Brucella* spp., *Salmonella* spp., *Shigella* spp., hepatitis C virus, and *Cryptosporidium* spp. accounted for 1,074 of the 1,267 infections. The authors also identified an additional 663 cases that presented as subclinical infections. Like Pike and Sulkin, Harding and Byers reported that only a small number of the LAI involved a documented specific incident. The non-specific associations reported most often by these authors were working with a microbiological agent, being in or around the laboratory, or being around infected animals.

The findings of Harding and Byers indicated that clinical (diagnostic) and research laboratories accounted for 45% and 51%, respectively, of the total LAIs reported. This is a marked difference from the LAIs reported by Pike and Sulkin prior to 1979, which indicated that clinical and research laboratories accounted for 17% and 59%, respectively. The relative increase of LAIs in clinical laboratories may be due in part to improved employee health surveillance programs that are able to detect subclinical infections, or to the use of inadequate containment procedures during the early stages of culture identification.

Comparison of the more recent LAIs reported by Harding and Byers with those reported by Pike and Sulkin suggests that the number is decreasing. Harding and Byers note that improvements in containment equipment, engineering controls, and greater emphasis on safety training may be contributing factors to the apparent reduction in LAIs over two decades. However, due to the lack of information on the actual numbers of infections and the population at risk, it is difficult to determine the true incidence of LAIs.

Publication of the occurrence of LAIs provides an invaluable resource for the microbiological and biomedical community. For example, one report of occupational exposures associated with *Brucella melitensis*, an organism capable of

transmission by the aerosol route, described how a staff member in a clinical microbiology laboratory accidentally sub-cultured *B. melitensis* on the open bench.⁸ This error and a breach in containment practices resulted in eight LAIs with *B. melitensis* among 26 laboratory members—an attack rate of 31%.

Reports of LAIs can serve as lessons in the importance of maintaining safe conditions in biomedical and clinical laboratories.

Evolution of National Biosafety Guidelines

National biosafety guidelines evolved from the efforts of the microbiological and biomedical community to promote the use of safe microbiological practices, safety equipment, and facility safeguards that reduce LAIs and protect public health and the environment. The historical accounts of LAIs raised awareness about the hazards of infectious microorganisms and the health risks to laboratory workers who handle them. Many published accounts suggested practices and methods that might prevent LAIs.⁹ Arnold G. Wedum was the Director of Industrial Health and Safety at the United States Army Biological Research Laboratories, Fort Detrick, from 1944 to 1969. His pioneering work in biosafety provided the foundation for evaluating the risks of handling infectious microorganisms and for recognizing biological hazards and developing practices, equipment, and facility safeguards for their control. Fort Detrick also advanced the field by aiding the development of biosafety programs at the United States Department of Agriculture (USDA), National Animal Research Center (NARC) and the United States Department of Health and Human Services (DHHS), Centers for Disease Control and Prevention (CDC), and National Institutes of Health (NIH). These governmental organizations subsequently developed several national biosafety guidelines that preceded the first edition of BMBL.

In 1974, the CDC published *Classification of Etiologic Agents on the Basis of Hazard*.¹⁰ This report introduced the concept for establishing ascending levels of containment that correspond to risks associated with handling infectious microorganisms that present similar hazardous characteristics. Human pathogens were grouped into four classes according to mode of transmission and the severity of disease they caused. A fifth class included non-indigenous animal pathogens whose entry into the United States was restricted by USDA policy.

The NIH published *National Cancer Institute Safety Standards for Research Involving Oncogenic Viruses* in 1974.¹¹ These guidelines established three levels of containment based on an assessment of the hypothetical risk of cancer in humans from exposure to animal oncogenic viruses or a suspected human oncogenic virus isolate.^{12,13} In 1976, NIH first published the *NIH Guidelines for Research Involving Recombinant DNA Molecules (NIH Guidelines)*.¹⁴ The current *NIH Guidelines* described in detail the microbiological practices, equipment, and facility safeguards that correspond to four ascending levels of physical

containment and established criteria for assigning experiments to a containment level based on an assessment of potential hazards of this continually evolving technology.¹⁵ The evolution of these guidelines set the foundation for developing a code of practice for biosafety in microbiological and biomedical laboratories. Led by the CDC and NIH, a broad collaborative initiative involving scientists, laboratory directors, occupational physicians, epidemiologists, public health officials, and health and safety professionals developed the first edition of BMBL in 1984.¹⁶ The BMBL provided the technical content not previously available in biosafety guidelines by adding summary statements conveying guidance pertinent to infectious microorganisms that had caused LAIs. The sixth edition of BMBL is also the product of a broad collaborative initiative committed to perpetuate the value of this national biosafety code of practice.

Risk Criteria for Establishing Ascending Levels of Containment

The primary risk criteria used to define the four ascending levels of containment, referred to as Biosafety Levels 1 through 4, are infectivity, severity of disease, transmissibility, and the nature of the work being conducted. Another important risk factor for agents that cause moderate to severe disease is the origin of the agent, whether indigenous or exotic. Each level of containment describes the microbiological practices, safety equipment, and facility safeguards for the corresponding level of risk associated with handling an agent. The facility safeguards associated with Biosafety Levels 1 through 4 help protect non-laboratory occupants of the facility, the public health, and the environment.

Biosafety Level 1 (BSL-1) is the basic level of protection and is appropriate for defined and characterized strains of viable biological agents that are not known to cause disease in immunocompetent adult humans. Biosafety Level 2 (BSL-2) is appropriate for handling moderate-risk agents that cause human disease of varying severity by ingestion or through percutaneous or mucous membrane exposure. Biosafety Level 3 (BSL-3) is appropriate for agents with a known potential for aerosol transmission, for agents that may cause serious and potentially lethal infections, and that are indigenous or exotic in origin. Exotic agents that pose a high individual risk of life-threatening disease by infectious aerosols and for which no treatment is available are restricted to high containment laboratories that meet Biosafety Level 4 (BSL-4) guidelines.

It is important to emphasize that the causative incident for most LAIs is unknown.^{7,8} Less obvious exposures such as the inhalation of infectious aerosols or direct contact of broken skin or mucous membranes with droplets containing an infectious microorganism or surfaces contaminated by droplets may possibly explain the incident responsible for a number of LAIs. Manipulations of liquid suspensions of microorganisms may produce aerosols and droplets. Small-particle aerosols have respirable size particles that may contain one or several microorganisms. These small particles stay airborne and easily disperse

throughout the laboratory. When inhaled, the human lung will retain these particles. Larger particle droplets rapidly fall out of the air, contaminating gloves, the immediate work area, and the mucous membranes of unprotected workers. A procedure's potential to release microorganisms into the air as aerosols and droplets is the most important operational risk factor that supports the need for containment equipment and facility safeguards.

Agent Summary Statements

The sixth edition, as in all previous editions, includes agent summary statements that describe the hazards, recommended precautions, and levels of containment appropriate for handling specific human and zoonotic pathogens in the laboratory and in facilities that house laboratory vertebrate animals. Agent summary statements are included for agents that meet one or more of the following three criteria:

1. The agent is a proven hazard to laboratory personnel working with infectious materials;
2. The agent is suspected to have a high potential for causing LAIs even though no documented cases exist; and
3. The agent causes grave disease or presents a significant public health hazard.

Scientists, clinicians, and biosafety professionals prepared the statements by assessing the risks of handling the agents using standard protocols followed in many laboratories. **No one should conclude that the absence of an agent summary statement for a human pathogen means that the agent is safe to handle at BSL-1 or without a risk assessment to determine the appropriate level of containment.** Laboratory directors should also conduct independent risk assessments before beginning work with an agent or procedure new to the laboratory, even though an agent summary statement is available. There may be situations where a laboratory director should consider modifying the precautionary measures or recommended practices, equipment, and facility safeguards described in an agent summary statement. In addition, laboratory directors should seek guidance when conducting risk assessments. Knowledgeable colleagues, institutional safety committees, institutional biosafety committees, biosafety officers, and public health, biosafety, and scientific associations are excellent resources.

The agent summary statements in the fifth edition of BMBL were reviewed in the course of preparing the sixth edition. There are new and updated agent summary statements including those for agents classified as Select Agents. For example, there is an updated section on arboviruses and related zoonotic viruses including new agent summary statements as well as statements for recently emerged agents such as Middle East Respiratory Syndrome coronavirus (MERS-CoV).

The sixth edition includes a substantially revised section on risk assessment that emphasizes the critical importance of this process in selecting the appropriate practices and level of containment. That section intentionally follows this introduction because risk assessment is the core principle that supports a code of practice for safe handling of infectious agents in microbiological and biomedical laboratories.

Laboratory Biosecurity

The nation also continues to face a challenge in safeguarding the public health from potential domestic or international bioterrorism. Existing standards and practices may require adaptation to ensure protection from such hostile actions. Federal regulations mandate increased security within the microbiological and biomedical community in order to protect high consequence biological pathogens and toxins from theft, loss, or misuse. The sixth edition of BMBL includes an update on laboratory biosecurity—the discipline addressing the security of microbiological agents and toxins and the threats posed to human and animal health, the environment, and the economy by deliberate misuse or release. A careful review of the laboratory biosecurity concepts and guidelines in [Section VI](#) is essential for all laboratory workers.

Using *Biosafety in Microbiological and Biomedical Laboratories*

BMBL is a code of practice and an authoritative reference. Knowledge sufficient to work safely with hazardous microorganisms requires a careful review of multiple sections of the BMBL. This will offer the reader an understanding of the biosafety principles that serve as the basis for the concepts and recommendations included in this reference. Reading only selected sections will not adequately prepare even an experienced laboratory worker to handle potentially infectious agents safely.

The recommended practices, safety equipment, and facility safeguards described in the BMBL are advisory. The intent was and is to establish a voluntary code of practice, one that all members of a laboratory community will together embrace to safeguard themselves and their colleagues, and to protect the public health and environment.

Additional appendices have been added to the sixth edition of the BMBL, including: [Appendix K—Inactivation and Verification](#); [Appendix L—Sustainability](#); [Appendix M—Large Scale Biosafety](#); and [Appendix N—Clinical Laboratories](#). In [Appendix K](#), content has been added on inactivation verification, as recent events have demonstrated that it may be insufficient to follow a published inactivation procedure and assume that it is capable of providing complete inactivation of all pathogenic organisms present in a sample. In [Appendix L](#), content has been added to assist laboratories with finding methods to reduce the significant operating costs associated with laboratories. In [Appendix M](#), biosafety considerations for large-scale production of agents has been added, in recognition of the

interest in the use of biological agents in the generation of biopharmaceuticals. Finally, in [Appendix N](#), content on the safe handling of biological materials in clinical laboratories has been added, as the risk assessment of handling specimens with unconfirmed but suspected high-risk agents can be significantly different from the assessment traditionally generated in microbiology laboratories.

The BMBL should not be used as a single source of biosafety information; it provides the basis for a rational risk assessment to be developed and reviewed by the competent stakeholders at an institution. Inclusion of all relevant stakeholders, including the biosafety office or officer, animal care staff, facilities staff, management, and the Institutional Biosafety Committee, or equivalent resource, is needed to ensure all relevant parties provide input and reach consensus on the risk assessment.

Looking Ahead

Although Laboratory-associated infections are infrequent, it is critical that the microbiological and biomedical communities continue their resolve to remain vigilant and avoid complacency. The widely reported incidents of accidental shipments of or potential exposures to high-consequence pathogens over the last several years demonstrate that accidents and unrecognized exposures continue to occur. The absence of clear evidence of the means of transmission in most documented LAIs should motivate persons at risk to be alert to all potential routes of exposure. The accidental release of microbial aerosols is a probable cause of many LAIs,¹⁷ which demonstrates the importance of worker training and the ability to recognize potential hazards and correct unsafe habits. Attention to and proficient use of work practices, safety equipment, and engineering controls are also essential.

Understanding the principles of biosafety, the use of well-executed risk assessments, and the adherence to the microbiological practices, containment, and facility safeguards described in BMBL will continue to contribute to a safer and healthier working environment for laboratory staff, adjacent personnel, and the community.

References

1. Richardson JH, Barkley WE, editors. *Biosafety in Microbiological and Biomedical Laboratories*. 1st ed. Washington (DC); 1984.
2. Sulkin SE, Pike RM. Survey of laboratory-acquired infections. *Am J Pub Hlth Nations Hlth*. 1951;41(7):769–81.
3. Pike RM, Sulkin SE, Schulze ML. Continuing importance of laboratory-acquired infections. *Am J Pub Hlth Nations Hlth*. 1965;55:190–9.
4. Pike RM. Laboratory-associated infections: summary and analysis of 3921 cases. *Health Lab Sci*. 1976;13(2):105–14.

5. Pike RM. Past and present hazards of working with infectious agents. *Arch Pathol Lab Med.* 1978;102(7):333–6.
6. Pike RM. Laboratory-associated infections: incidence, fatalities, causes, and prevention. *Annu Rev Microbiol.* 1979;33:41–66.
7. Harding AL, Byers KB. Epidemiology of Laboratory-associated infections. In: Fleming DO, Hunt DL, editors. *Biological Safety: Principles and Practices.* 3rd ed. Washington (DC): ASM Press; 2000. p. 35–54.
8. Staskiewicz J, Lewis CM, Colville J, Zervos M, Band J. Outbreak of *Brucella melitensis* among microbiology laboratory workers in a community hospital. *J Clin Microbiol.* 1991;29(2):287–90.
9. Wedum AG. Laboratory safety in research with infectious diseases. *Public Health Rep.* 1964;79(7):619–33.
10. Ad Hoc Committee on the Safe Shipment and Handling of Etiologic Agents; Center for Disease Control. *Classification of etiologic agents on the basis of hazard.* 4th ed. Atlanta (GA): U.S. Department of Health, Education, and Welfare, Public Health Service, Center for Disease Control, Office of Biosafety; 1974.
11. National Cancer Institute, Office of Research Safety. *National Cancer Institute safety standards for research involving oncogenic viruses.* Bethesda: The National Institutes of Health (US); 1974.
12. Wedum AG. History and epidemiology of laboratory-acquired infections (in relation to the cancer research program). *JABSA.* 1997;2(1):12–29.
13. West DL, Twardzik DR, McKinney RW, Barkley WE, Hellman A. Identification, analysis, and control of biohazards in viral cancer research. In: Fuscaldo AA, Erlick BJ, Hindman B, editors. *Laboratory safety theory and practice.* New York: Academic Press; 1980. p. 167–223.
14. National Institutes of Health. *NIH Guidelines for Research Involving Recombinant DNA Molecules (NIH Guidelines).* Bethesda (MD): National Institutes of Health; 1976.
15. National Institutes of Health. *NIH Guidelines for Research Involving Recombinant or Synthetic Nucleic Acid Molecules (NIH Guidelines).* Bethesda (MD): National Institutes of Health, Office of Science Policy; 2019.
16. Centers for Disease Control and Prevention; National Institutes of Health. *Biosafety in Microbiological and Biomedical Laboratories.* 1st ed. Richardson JH, Barkley WE, eds. Atlanta (GA): CDC; Bethesda (MD): NIH; Washington (DC): U.S. G.P.O.; 1984.
17. Rusnak JM, Kortepeter MG, Hawley RJ, Anderson AO, Boudreau E, Eitzen E. Risk of occupationally acquired illnesses from biological threat agents in unvaccinated laboratory workers. *Biosecur Bioterror.* 2004;2(4):281–93.

Section II—Biological Risk Assessment

The ongoing practice of biological risk assessment is the foundation of safe laboratory operations. Risk assessment requires careful judgment and is an important responsibility for directors and principal investigators (PI) of microbiological and biomedical laboratories. Institutional leadership and oversight resources, such as Institutional Biosafety Committees (IBCs) or equivalent resources, animal care and use committees, biological safety professionals, occupational health staff, and laboratory animal veterinarians also share in this responsibility. When assessing risk, it is essential to broadly engage stakeholders, including laboratory and facility staff and subject matter experts, in committee reviews of work and discussions of past studies of Laboratory-associated infections (LAIs) and other published research. The biological risk assessment process is used to identify the hazardous characteristics of an infectious or potentially infectious agent or material, if known; the activities that can result in a person's exposure to an agent; the likelihood that such exposure will cause an LAI; and the probable consequences of such an infection. The information identified by risk assessment will provide a guide for the selection of appropriate mitigations, including the application of Biosafety Levels and good microbiological practices, safety equipment, and facility safeguards that can help prevent LAIs.

Promoting a positive culture of safety by integrating a risk management process into daily laboratory operations results in the ongoing identification of hazards and prioritization of risks and the establishment of risk mitigation protocols tailored to specific situations. To be successful, this process must be collaborative and inclusive of all stakeholders. Further, it must recognize a hierarchy of controls, beginning with the elimination or reduction of hazards, then progress to implementing the appropriate engineering and/or administrative controls to address residual risks, and, if necessary, identifying personal protective equipment (PPE) to protect the worker.¹

For the purposes of this section, hazards are defined as substances or situations capable of causing adverse effects to health or safety.² Risks occur when people interact with hazards and are a function of both the probability of adverse events and expected consequences of a potential incident.² The product of probability and consequence estimates provide a relative value that can be used to prioritize risks. Since it is impossible to eliminate all risk, unless the associated hazard is eliminated, the risk assessment evaluates recognized risks associated with a particular hazard and reduces risk to an institutionally acceptable level through a documented process. For the biological laboratory, this process is usually qualitative with classifications from high- to low-risk. This section provides guidance on conducting a risk assessment, implementing a risk mitigation program, communicating during and after the assessment, and developing practices to support ongoing application of the risk assessment process.

Risks are best mitigated by combining and overlapping risk management practices and risk mitigation controls to offer redundant protections for the worker, community, and the environment. Working through the risk assessment process identifies best practices for manipulating biological agents, how to integrate multiple containment or protection strategies, and how to respond if something does not go as planned. When performed comprehensively, it accounts for changing methodologies, procedures, and regulations as the work evolves.

Adverse consequences, like LAIs, are more likely to occur if the risks are unidentified or underestimated. By contrast, imposition of safeguards more rigorous than needed may result in additional expense and burden for the laboratory with little enhancement of laboratory safety. However, where there is insufficient information to make a clear determination of risk, consider the need for additional safeguards until more data are available.

The Risk Management Process

The sixth edition of *Biosafety in Microbiological and Biomedical Laboratories (BMBL)* provides guidance on risk mitigation measures to address common agent and protocol risks. As all possible adverse incidents can't be predicted, judgments and decisions about control measures sometimes need to be based on incomplete information. Special risks, associated with a particular type of laboratory, may require more caution in the risk assessment; for example, clinical laboratories rarely have the benefit of agent information, as they are typically looking to identify the causative agent for a medical diagnosis. Please refer to [Appendix N](#) for additional information on clinical laboratories.

This section describes a six-step approach that gives structure to the risk management process and reinforces an ongoing positive culture of safety. Other methodologies may be useful, including the process described in the WHO Laboratory Biosafety Manual.

The initial factors to consider in risk assessment fall into two broad categories: agent hazards and laboratory procedure hazards. Following the assessment of the inherent risk, the Biosafety Level and any additional indicated mitigation strategies are determined. Before implementation of the controls, the risk assessment and selected safeguards should be reviewed with a biosafety professional, subject matter expert, and the IBC or equivalent resource. Then, as part of an ongoing assessment of risk management, the proficiency of staff regarding safe practices and the integrity of safety equipment is evaluated and training or competency gaps are addressed. Finally, the management strategies are revisited regularly to reassess risks and mitigations and are updated when appropriate.

First, identify hazardous characteristics of the agent and perform an assessment of the inherent risk, which is the risk in the absence of mitigating factors. Consider the principal hazardous characteristics of the agent, which include its capability to infect and cause disease in a susceptible host, severity of disease, and the availability of preventive measures and effective treatments. Also consider possible routes of transmission of infection in the laboratory, infectious dose (ID), stability in the environment, host range, whether the agent is indigenous or exotic to the local environment, and the genetic characteristics of the agent.³⁻⁶

Several excellent resources provide information and guidance for making an initial risk assessment. [Section VIII](#) of BMBL provides agent summary statements for many agents that are associated with LAIs or are of increased public concern. Agent summary statements also identify known and suspected routes of transmission of Laboratory-associated infections and, when available, information on infective dose, host range, agent stability in the environment, protective immunizations, and attenuated strains of the agent. Safety documents from reputable sources are also valuable, such as the Pathogen Data Safety Sheets generated by the Public Health Agency of Canada (PHAC); the Pathogen Data Safety Sheets are available at <https://www.canada.ca/en/public-health/services/laboratory-biosafety-biosecurity/pathogen-safety-data-sheets-risk-assessment.html>. A thorough examination of the agent hazards is necessary when the intended use of an agent does not correspond with the general conditions described in the agent summary statement or when an agent summary statement is not available. In addition, it is always helpful to seek guidance from colleagues with experience in handling the agent and from biological safety professionals.

The *NIH Guidelines for Research Involving Recombinant or Synthetic Nucleic Acid Molecules (NIH Guidelines)* has incorporated an agent Risk Group (RG) classification for laboratory use that describes four general Risk Groups based on these principle characteristics and the route of transmission of the natural disease; this list is found in Appendix B of the *NIH Guidelines*. ABSA International also has a compendium of organisms and Risk Group assignments from several countries and organizations available at <https://my.absa.org/Riskgroups>. Agent Risk Group assignments assist with an initial estimate of the pathogen's risk; the assessment must be modified appropriately based on the unique risks faced by each laboratory for the specific work being done. **The four groups address the risk to both the laboratory worker and the community and correlate with, but do not equate to, Biosafety Levels.** See [Section III](#) for additional information about Risk Groups and Biosafety Levels.

Genetically modified agent hazardous characteristics The identification and assessment of hazardous characteristics of genetically modified agents involve consideration of the same factors used in risk assessment of the wild-type organism. It is particularly important to address the possibility that the genetic modification could increase or decrease an agent's pathogenicity or affect its susceptibility to antibiotics or other effective treatments. The risk assessment can be difficult or incomplete because important information may not be available for a newly engineered agent. Several investigators have reported that they observed unanticipated enhanced virulence in recent studies with engineered agents,⁷⁻¹⁰ these observations give reasons to remain alert to the possibility that experimental alteration of virulence genes may lead to altered risk and reinforce the nature of risk assessment as a continuing process that requires updating as research progresses.

The *NIH Guidelines* are the key reference in assessing risk and establishing an appropriate Biosafety Level for work involving recombinant DNA molecules. Please refer to [Appendix J](#) for more information about the *NIH Guidelines* and the NIH Office of Science Policy (OSP). The NIH Guidelines are available at https://osp.od.nih.gov/wp-content/uploads/NIH_Guidelines.pdf.¹¹

Cell Cultures Workers who handle or manipulate human or animal cells and tissues are at risk for possible exposure to potentially infectious latent and adventitious agents that may be present in those cells and tissues. This risk is illustrated by the reactivation of herpes viruses from latency,^{12,13} the inadvertent transmission of disease to organ recipients,^{14,15} and the persistence of human immunodeficiency virus (HIV), hepatitis B virus (HBV), and hepatitis C virus (HCV) within infected individuals in the U.S. population.¹⁶ In addition, human and animal cell lines that are not well characterized or are obtained from secondary sources may introduce an infectious hazard to the laboratory. For example, the handling of nude mice inoculated with a tumor cell line unknowingly infected with lymphocytic choriomeningitis virus resulted in multiple LAIs.¹⁷ See [Appendix H](#) for additional information.

Other hazardous characteristics of an agent include probable routes of transmission in the laboratory, infective dose, stability in the environment, host range, and its endemic nature. In addition, reports of LAIs are a clear indicator of hazard and often are sources of information helpful for identifying agent and procedural hazards, and the precautions for their control. The absence of a report does not indicate minimal risk. The number of infections reported for a single agent may be an indication of the frequency of use as well as risk. Reporting of LAIs by laboratory directors in scientific and medical literature is encouraged. The agent summary statements in BMBL include specific references to reports on LAIs.

Once the inherent risk associated with the agent is considered, the next step in the process involves addressing the possibility of transmission of the agent. The most likely routes of transmission in the laboratory are:

1. Direct skin, eye or mucosal membrane exposure to an agent;
2. Parenteral inoculation by a syringe needle or other contaminated sharp, or by bites from infected animals and arthropod vectors;
3. Ingestion of liquid suspension of an infectious agent, or by contaminated hand to mouth exposure; and
4. Inhalation of infectious aerosols.

An awareness of the routes of transmission for the natural human disease is helpful in identifying probable routes of transmission in the laboratory and the potential for any risk to public health. For example, transmission of infectious agents can occur by direct contact with discharges from respiratory mucous membranes of infected persons, which would be a clear indication that a laboratory worker is at risk of infection from mucosal membrane exposure to droplets generated while handling that agent. Additional information used to identify both natural and often noted laboratory modes of transmission can be found in the *Control of Communicable Diseases Manual*.³ It is important to remember that the nature and severity of disease caused by a Laboratory-associated infection and the probable route of transmission of the infectious agent in the laboratory may differ from the route of transmission and severity associated with the naturally-acquired disease.¹⁸

An agent capable of transmitting disease through respiratory exposure to infectious aerosols is a serious laboratory hazard, both for the person handling the agent and for other laboratory occupants. Infective dose and agent stability are particularly important in establishing the risk of airborne transmission of disease. For example, the reports of multiple infections in laboratories associated with the use of *Coxiella burnetii* are explained by its low inhalation infective dose, which is estimated to be 10 inhaled infectious particles, and its resistance to environmental stresses that enables the agent to survive outside of a living host or culture media long enough to become an aerosol hazard.¹⁹

When work involves the use of laboratory animals, the hazardous characteristics of zoonotic agents require careful consideration when completing a risk assessment. Evidence that experimental animals can shed zoonotic agents and other infectious agents under study in saliva, urine, or feces is an important indicator of hazard. The death of a primate center laboratory worker from Macacine herpesvirus 1 (MHV-1, also known as Monkey B virus) infection following an ocular splash exposure to biologic material from a rhesus macaque emphasizes the seriousness of this hazard.²⁰ Experiments that demonstrate

transmission of disease from an infected animal to a normal animal housed in the same cage are reliable indicators of hazard. Experiments that do not demonstrate transmission, however, do not rule out the hazard. For example, experimental animals infected with *Francisella tularensis*, *Coxiella burnetii*, *Coccidioides immitis*, or *Chlamydia psittaci*—agents that have caused many LAIs—rarely infect cagemates.²¹

The origin of the agent is also important when conducting a risk assessment. Non-indigenous agents are of special concern because of their potential to transmit or spread infectious diseases from foreign countries into the United States. Importation of agents of human disease requires a permit from the CDC. Importation of many agents of livestock, poultry, and other animal diseases requires a permit from the USDA's Animal and Plant Health Inspection Service (APHIS). For additional details, see [Appendix C](#).

Often, there is not sufficient information to make an appropriate assessment of risk. For example, the hazard of an unknown agent that may be present in a specimen may not be known until the completion of agent identification and typing procedures. It would be prudent to assume the specimen contains an unknown agent presenting the hazardous classification that correlates with a minimum of BSL-2 containment, unless additional information suggests the presence of an agent of higher risk. Identification of agent hazards associated with newly emergent pathogens also requires judgments based on incomplete information. Often, epidemiologic findings are the best sources for information in these cases. When assessing the hazards of a newly attenuated pathogen, experimental data should support a judgment that the attenuated pathogen is less hazardous than the wild-type parent pathogen before making any reduction in the containment recommended for that pathogen.

Second, identify laboratory procedure hazards. The principal laboratory procedure hazards are agent concentration, suspension volume, equipment and procedures that generate small particle aerosols and larger airborne particles (droplets), and use of sharps. Procedures involving animals can present a number of hazards such as bites and scratches, exposure to zoonotic agents, and the handling of experimentally generated infectious aerosols.

Investigations of LAIs have identified the following routes of transmission: parenteral inoculations with syringe needles or other contaminated sharps, spills and splashes onto skin and mucous membranes, ingestion through mouth pipetting, animal bites and scratches, and inhalation exposures to infectious aerosols. The first four routes of laboratory transmission were easy to detect but accounted for less than 20% of the LAIs reported in the 1979 retrospective review by Pike.²² Subsequent research on LAIs has confirmed that the probable sources of infection are frequently not known.²³

Aerosols and droplets Aerosols are a serious hazard because they are ubiquitous in laboratory procedures, are usually undetected, and are extremely pervasive, placing the laboratory worker carrying out the procedure and other persons in the laboratory at risk of exposure. There is general agreement among biosafety professionals, laboratory directors, and principal investigators who have investigated LAIs that an aerosol generated by procedures and operations is the probable source of many LAIs, particularly in cases involving workers whose only known risk factor was that they worked with an agent or were in an area where that work was done.

Procedures that impart energy to a microbial suspension will produce aerosols. Equipment used for handling and analyzing infectious agents in laboratories, such as pipettes, blenders, centrifuges, sonicators, vortex mixers, cell sorters, and matrix-assisted laser desorption/ionization-time of flight (MALDI-TOF) mass spectrometers are potential sources of aerosols.^{24,25} These procedures and equipment generate respirable-size particles that remain airborne for protracted periods. These particles can remain in the lungs if inhaled or create an exposure hazard for coworkers in the laboratory or persons occupying adjacent spaces open to airflow from the laboratory. A number of investigators have determined the aerosol output of common laboratory procedures. In addition, investigators have proposed a model for estimating inhalation dosage from a laboratory aerosol source. Parameters that characterize aerosol hazards include an agent's inhalation infective dose, its viability in an aerosol, aerosol concentration, and particle size.^{26–28}

A careful and proficient worker will minimize the generation of aerosols. For example, the hurried worker may operate a sonic homogenizer with maximum aeration, but the careful worker will consistently operate the device to ensure minimal aeration. Experiments show that the aerosol burden with maximal aeration is approximately 200 times greater than aerosol burden with minimal aeration.²⁶ Similar results were shown for improper pipetting which generated bubbles versus pipetting with minimal bubble generation.

Procedures and equipment that generate respirable size particles also generate larger size droplets that settle out of the air rapidly, contaminating hands, work surfaces, and possibly the mucous membranes of the persons performing the procedure. An evaluation of the release of both respirable particles and droplets from laboratory operations determined that the respirable component is relatively small; in contrast, hand and surface contamination can be substantial.²⁹ The potential risk from exposure to droplet contamination requires as much attention in a risk assessment as the respirable component of aerosols.

Personal Protective Equipment (PPE) and Safety Equipment Hazards There may be hazards that require specialized PPE in addition to safety glasses,

laboratory gowns, and gloves. For example, a procedure that presents a splash hazard may require the use of a mask and a face shield to provide adequate protection. Inadequate training in the proper use of PPE may reduce its effectiveness, provide a false sense of security, and could increase the risk to the laboratory worker. For example, a respirator worn incorrectly may impart a risk to the wearer independent of the agents being manipulated.

Safety equipment such as biological safety cabinets (BSCs), centrifuge safety cups, and sealed rotors are used to provide a high degree of protection for the laboratory worker from exposure to microbial aerosols and droplets. Safety equipment that is not working properly is hazardous, especially when the user is unaware of the malfunction. Poor location, room air currents, decreased airflow, leaking filters, raised sashes, crowded work surfaces, and poor user technique compromise the containment capability of a BSC. The safety characteristics of modern centrifuges are only effective if the equipment is operated properly.

Facility Control Hazards Facility safeguards help prevent the accidental release of an agent from the laboratory. For example, one facility safeguard is directional airflow, which helps to prevent aerosol transmission from a laboratory into other areas of the building. Directional airflow is dependent on the operational integrity of the laboratory's heating, ventilation, and air conditioning (HVAC) system. HVAC systems require careful monitoring and periodic maintenance to sustain operational integrity. Loss of directional airflow may compromise safe laboratory operation. BSL-4 containment facilities provide more complex safeguards that require significant expertise to design and operate.

Consideration of facility safeguards is an integral part of the risk assessment. A biological safety professional, building and facilities staff, and the IBC, or equivalent safety committee, should help assess the facility's capability to provide appropriate protection for the planned work and recommend changes as necessary. Risk assessment may support the need to include additional facility safeguards in the construction of new or renovation of old facilities.

Third, make a determination of the appropriate Biosafety Level and select additional precautions indicated by the risk assessment. The selection of the appropriate Biosafety Level and the selection of any additional laboratory precautions require a comprehensive understanding of the practices, safety equipment, and facility safeguards described in [Sections III, IV, and V](#) of this publication.

There will be situations where the intended use of an agent requires greater precautions than those described in the agent's summary statement. These situations will require the careful selection of additional precautions. An obvious example would be a procedure for exposing animals to experimentally generated infectious aerosols.

It is unusual that a risk assessment would indicate a need to alter the recommended facility safeguards specified for the selected Biosafety Level. If this does occur, it is important that a biological safety professional validate this judgment before augmenting any facility secondary barrier.

While an entity's biosafety plan is based on a risk assessment, the biosafety plan may be influenced by federal regulations and guidelines. For example, the 2017 notice published by the National Science Foundation (NSF) defines standard terms and conditions for federal research grants.³⁰ A listing of statutory, regulatory, and executive requirements is provided in Appendix C of the updated National Policy Requirements Matrix.³¹ The biosafety plan required by the Federal Select Agents and Toxins regulations (9 CFR Part 121, 42 CFR Part 73) must be based on an assessment that addresses the risk of the Select Agent or Toxin given its intended use and consider, where appropriate, the *NIH Guidelines for Research Involving Recombinant or Synthetic Nucleic Acid Molecules*. It is also important to recognize that individuals in the laboratory may differ in their susceptibility to disease. Pre-existing conditions, medications, compromised immunity, and pregnancy or breast-feeding that may increase exposure of infants to certain agents are some of the conditions that may increase the risk of an individual for acquiring an LAI. Consultation with an occupational health care provider knowledgeable in infectious diseases is advisable in these circumstances.

Laboratory directors and principal investigators, or their designees, are responsible for ensuring that the identified controls (equipment, administrative, and PPE) have been made available and are adhered to or operating properly. For example, a BSC that is not certified represents a potentially serious hazard to the laboratory worker using it and to others in the laboratory. The director should have all equipment deficiencies corrected before starting work with an agent. Vaccination(s) may be recommended for laboratory personnel based on safety and availability; however, the protection afforded by a vaccine to an individual depends on the effectiveness of the vaccine and duration of immunity. Vaccination does not substitute for engineering and administrative risk mitigation controls.

Institutions must address risk perception by setting risk tolerance limits or performance expectations on program elements and equipment identified as critical to operations.^{32,33} Risk mitigation requires finding a balanced approach that includes ongoing hazard identification and review of control measures with a commitment at all levels to reduce identified risk to a level tolerable to the institution. Risk acceptance is not equal acceptance of all risks; a level of biological risk may be essential to performing research, while acceptance of an equal risk of scientific misconduct is not.

Fourth, before implementation of the controls, review the risk assessment and selected safeguards with a biosafety professional, subject matter expert, and the IBC or equivalent resource. This review is strongly recommended and may be required by regulatory or funding agencies. Review of potentially high-risk protocols by the IBC should become standard practice. Adopting this step voluntarily will promote the use of safe practices in work with hazardous agents in microbiological and biomedical laboratories.

Fifth, as part of an ongoing process, evaluate the proficiencies of staff regarding safe practices and the integrity of safety equipment. The protection of laboratory workers, other persons associated with the laboratory, and the public will depend ultimately on the laboratory workers themselves. The laboratory director or principal investigator should ensure that laboratory workers have acquired the technical proficiency in the use of microbiological practices and safety equipment required for the safe handling of the agent and have developed good habits that sustain excellence in the performance of those practices. Staff at all skill levels need to know how to identify hazards in the laboratory and how to obtain assistance in protecting themselves and others in the laboratory. An evaluation of a worker's training, experience in handling infectious agents, proficiency in following good microbiological practices, correct use of safety equipment, consistent use of standard operating procedures (SOPs) for specific laboratory activities, ability to respond to emergencies, and willingness to accept responsibility for protecting one's self and others is an important indication that a laboratory worker is capable of working safely.

An assessment should identify any potential deficiencies in the knowledge, competency, and practices of the laboratory workers. Carelessness is a serious concern because it can compromise any safeguards of the laboratory and increase the risk for coworkers. Fatigue and its adverse effects on safety have been well documented.³⁴ Training, experience, knowledge of the agent and procedure hazards, good habits, caution, attentiveness, and concern for the health of coworkers are prerequisites for laboratory staff in order to reduce the risks associated with work with hazardous agents. Not all workers who join a laboratory staff will have these prerequisite traits even though they may possess excellent scientific credentials. Laboratory directors or principal investigators should consider the use of competency assessment(s) to train and retrain new staff to the point where aseptic techniques and safety precautions become second nature.³⁵⁻³⁷

Sixth, revisit regularly and verify risk management strategies and determine if changes are necessary. Continue the risk management cycle, and adjust and adapt as the need arises. This includes a regular update of biosafety manuals and SOPs when changes in procedures or equipment occur. A cyclical, adaptable

risk management process forms the basis for a robust culture of safety in the biological laboratory.

Risk Communication

An effective culture of safety depends on the effective communication and reporting of risk indicators, including incidents and near misses, in a non-punitive manner.³⁸ Documents communicating the fundamental elements of a safety program are an important part of this culture and form the basis of the risk assessment; this includes hazard communication to all stakeholders.³⁹

Institutional leadership can engage workers at all levels by collaborating with institutional safety programs and committing to and supporting a safe working environment.

Institutions that work with infectious agents and toxins need an appropriate organizational and governance structure to ensure compliance with biosafety, biocontainment, and laboratory biosecurity regulations and guidelines, and to communicate risks.⁴⁰ In particular, the principal investigator or the facility equivalent has the primary responsibility for communicating hazards and risks in the laboratory. Staff must have the ability to report issues, including incidents and near misses without fear of reprisal. Laboratory staff, IBCs or equivalent resource, biosafety professionals, Institutional Animal Care and Use Committees (IACUCs), and laboratory animal veterinarians also have responsibility for identifying biological risks associated with laboratory work and communicating institute-wide risk management practices. A biosafety officer (BSO) and/or other safety personnel can coordinate the institution's safety program and may assist in the development of risk communication documents including incident trends and mitigations, SOPs, biosafety manuals, hazard control plans, and emergency response plans. Risk management can identify deficiencies in laboratory worker performance or institutional policies and assists institutional leadership responsible to make the necessary changes to safety programs to address those deficiencies. Biosafety program changes that promote the building of a culture of safety are most effectively communicated across the institution using multiple communication routes to ensure that all staff are informed. Good communication practices include messages from leadership, risk management documents, IBCs or equivalent resource, and other committee reviews, as necessary.

Facilitating a Culture of Safety through Risk Assessment

The goal of your risk assessment is to address all realistic, perceivable risks to protect personnel, the community, and the environment. Research progress, changes in personnel, and changes in regulation over time drive programmatic change and demand reconsideration of all factors, as periodically necessary. Risk assessment is an ongoing process, and all personnel have a role in its success.

The challenge is to develop good habits and procedures through training and competency checks with the support of leadership. Once established, these practices will persist to further instill a culture of safety. A sound risk communication strategy is also critical for both hazard identification and successful implementation. While policies and plans are tangible assets derived from the risk assessment process, the ultimate success will be measured by whether you establish, strengthen, and sustain a culture of safety while encouraging communication about risks between management and staff to prevent accidents before they happen.

The regular review of all hazards, prioritization of risk, multidisciplinary review of priority risks, and establishment of risk mitigation measures demonstrate the institution's commitment to a safe and secure working environment and form the cornerstone of a biosafety program. The approach to risk assessment outlined in the preceding section is not static and benefits from active participation by all relevant stakeholders. Aim for ongoing evaluation and periodic readjustments to stay aligned with the changing needs of the institution and to protect all persons from potential exposure to biological materials in laboratories and associated facilities.

Conclusion

The BMBL is designed to assist organizations with the protection of workers in biological laboratories and associated facilities from Laboratory-associated infections. Risk assessment is the basis for the safeguards developed by the CDC, the NIH, and the microbiological and biomedical community to protect the health of laboratory workers and the public from the risks associated with the use of hazardous biological agents in laboratories. Experience shows that these established safe practices, equipment, and facility safeguards work; new knowledge and experience may justify altering these safeguards.

References

1. United States Department of Labor [Internet]. Washington (DC): Occupational Safety and Health Administration; c2016 [cited 2019 Jan 7]. Recommended Practices for Safety and Health Programs. Available from: https://www.osha.gov/shpguidelines/docs/OSHA_SHP_Recommended_Practices.pdf
2. Caskey S, Sevilla-Reyes EE. Risk Assessment. In: Laboratory Biorisk Management: Biosafety and Biosecurity. Salerno RM, Gaudioso, J, editors. Boca Raton: CRC Press; 2015. p. 45–63.
3. Heymann DL, editor. Control of Communicable Diseases Manual. 20th ed. Washington (DC): American Public Health Association Press; 2014.

4. Bennett JE, Dolin R, Blaser MJ, editors. Mandell, Douglas, and Bennett's Principles and Practice of Infectious Diseases. 8th ed. Philadelphia (PA); Elsevier Saunders; 2015.
5. Government of Canada [Internet]. Canada: Public Health Agency of Canada; c2018 [cited 2019 Jan 7]. Pathogen Safety Data Sheets. Available from: <https://www.canada.ca/en/public-health/services/laboratory-biosafety-biosecurity/pathogen-safety-data-sheets-risk-assessment.html>
6. absa.org [Internet]. Mundelein (IL): American Biological Safety Association International; [cited 2019 Jan 7]. Available from: <https://absa.org>.
7. Jackson RJ, Ramsay AJ, Christensen CD, Beaton S, Hall DF, Ramshaw IA. Expression of Mouse Interleukin-4 by a Recombinant Ectromelia Virus Suppresses Cytolytic Lymphocyte Responses and Overcomes Genetic Resistance to Mousepox. *J Virol*. 2001;75(3):1205–10.
8. Shimono N, Morici L, Casali N, Cantrell S, Sidders B, Ehrt S, et al. Hypervirulent mutant of *Mycobacterium tuberculosis* resulting from disruption of the *mce1* operon. *Proc Natl Acad Sci USA*. 2003;100(26):15918–23.
9. Cunningham ML, Titus RG, Turco SJ, Beverley SM. Regulation of Differentiation to the Infective Stage of the Protozoan Parasite *Leishmania major* by Tetrahydrobiopterin. *Science*. 2001;292(5515):285–7.
10. Kobasa A, Takada A, Shinya K, Hatta M, Halfmann P, Theriault S, et al. Enhanced Virulence of Influenza A Viruses with the Haemagglutinin of the 1918 Pandemic Virus. *Nature*. 2004;431(7009):703–7.
11. National Institutes of Health. NIH Guidelines for Research Involving Recombinant or Synthetic Nucleic Acid Molecules (NIH Guidelines). Bethesda (MD): National Institutes of Health, Office of Science Policy; 2019.
12. Efstathiou S, Preston CM. Towards an Understanding of the Molecular Basis of Herpes Simplex Virus Latency. *Virus Res*. 2005;111(2):108–19.
13. Oxman MN, Levin MJ, Johnson GR, Schmader KE, Straus SE, Gelb LD, et al. A Vaccine to Prevent Herpes Zoster and Postherpetic Neuralgia in Older Adults. *N Engl J Med*. 2005;352(22):2271–84.
14. Centers for Disease Control and Prevention. Investigation of Rabies Infections in Organ Donor and Transplant Recipients—Alabama, Arkansas, Oklahoma, and Texas, 2004. *MMWR Morb Mortal Wkly Rep*. 2004;53(26):586–9.
15. Centers for Disease Control and Prevention. Lymphocytic Choriomeningitis Virus Infection in Organ Transplant Recipients—Massachusetts, Rhode Island, 2005. *MMWR Morb Mortal Wkly Rep*. 2005;54(21):537–9.
16. Bloodborne pathogens, 29 C.F.R. Part 1910.1030 (1992).

17. Dykewicz CA, Dato VM, Fisher-Hoch SP, Howarth MV, Perez-Oronoz GI, Ostroff SM, et al. Lymphocytic Choriomeningitis Outbreak Associated with Nude Mice in a Research Institute. *JAMA*. 1992;267(10):1349–53.
18. Lennette EH, Koprowski H. Human Infection With Venezuelan Equine Encephalomyelitis Virus: A Report on Eight Cases of Infection Acquired in the Laboratory. *JAMA*. 1943;123(17):1088–95.
19. Tigertt WD, Benenson AS, Gochenour WS. Airborne Q Fever. *Bacteriol Rev*. 1961;25:285–93.
20. Centers for Disease Control and Prevention. Fatal *Cercopithecine herpesvirus 1* (B virus) Infection Following a Mucocutaneous Exposure and Interim Recommendations for Worker Protection. *MMWR Morb Mortal Wkly Rep*. 1998;47(49):1073–6, 1083.
21. Wedum AG, Barkley WE, Hellman A. Handling of Infectious Agents. *J Am Vet Med Assoc*. 1972;161(11):1557–67.
22. Pike RM. Laboratory-associated infections: Incidence, Fatalities, Causes and Prevention. *Annu Rev Microbiol*. 1979;33:41–66.
23. Byers KB, Harding, AL. Laboratory-associated infections. In: Wooley DP, Byers KB, editors. *Biological Safety: Principles and Practices*. 5th ed. Washington (DC): ASM Press; 2017. p. 59–92.
24. Pomerleau-Normandin D, Heisz M, Su M. Misidentification of Risk Group 3/Security Sensitive Biological Agents by MALDI-TOF MS in Canada: November 2015–October 2017. *Can Commun Dis Rep*. 2018;44(5):100–15.
25. Holmes KL. Characterization of aerosols produced by cell sorters and evaluation of containment. *Cytometry A*. 2011;79(12):1000–8.
26. Dimmick RL, Fogl WF, Chatigny MA. Potential for Accidental Microbial Aerosol Transmission in the Biology Laboratory. In: Hellman A, Oxman MN, Pollack R, editors. *Biohazards in Biological Research: Proceedings of a conference held at the Asilomar conference center; 1973 Jan 22–24; Pacific Grove (CA)*. New York: Cold Spring Harbor Laboratory; 1973. p. 246–66.
27. Kenny MT, Sabel FL. Particle Size Distribution of *Serratia marcescens* Aerosols Created During Common Laboratory Procedures and Simulated Laboratory Accidents. *Appl Microbiol*. 1968;16(8):1146–50.
28. Chatigny MA, Barkley WE, Vogl WF. Aerosol biohazard in microbiological laboratories and how it is affected by air conditioning systems. *ASHRAE Transactions*. 1974;80(Pt 1):463–9.
29. Chatigny MA, Hatch MT, Wolochow H, et al. Studies on release and survival of biological substances used in recombinant DNA laboratory procedures. *National Institutes of Health Recombinant DNA Technical Bulletin*. 1979;2:62–7.

30. National Science Foundation. Final Notice of Research Terms and Conditions (RTC) To Address and Implement the Uniform Administrative Requirements, Cost Principles, and Audit Requirements for Federal Awards Issued by the U.S. Office of Management and Budget (OMB). *Fed Regist.* 2017;82(48):13660–1.
31. National Science Foundation [Internet]. Alexandria (VA): Research Terms and Conditions; c2017 [cited 2019 Jan 8]. Appendix C National Policy Requirements. Available from: https://www.nsf.gov/bfa/dias/policy/fedrtrc/appc_march17.pdf
32. Vaughan D. *The Challenger Launch Decision: Risky Technology, Culture, and Deviance at NASA*. Chicago: The University of Chicago Press; 1996.
33. *History as Cause: Columbia and Challenger*. Washington (DC): Columbia Accident Investigation Board; 2003 Aug. Report Vol.: 1. p. 195–204.
34. Caldwell JA, Caldwell JL, Tompson LA, Liberman, HR. Fatigue and its management in the workplace. *Neurosci Biobehav Rev.* 2019;96:272–89.
35. Lennette EH. Panel V common sense in the laboratory: recommendations and priorities. In: Hellman A, Oxman MN, Pollack R, editors. *Biohazards in Biological Research: Proceedings of a conference held at the Asilomar conference center; 1973 Jan 22–24; Pacific Grove (CA)*. New York: Cold Spring Harbor Laboratory; 1973. p. 353.
36. Delany JR, Pentella MA, Rodriguez JA, Shah KV, Baxley KP, Holmes DE; Centers for Disease Control and Prevention. Guidelines for biosafety laboratory competency: CDC and the Association of Public Health Laboratories. *MMWR Suppl.* 2011;60(2):1–23.
37. Ned-Sykes R, Johnson C, Ridderhof JC, Perlman E, Pollock A, DeBoy JM; Centers for Disease Control and Prevention (CDC). Competency Guidelines for Public Health Laboratory Professionals: CDC and the Association of Public Health Laboratories. *MMWR Suppl.* 2015;64(1):1–81.
38. Behaviors that undermine a culture of safety. *Sentinel Event Alert.* 2008;(40):1–3.
39. United States Department of Labor [Internet]. Washington (DC): Occupational Safety and Health Administration; c2016 [cited 2019 Jan 7]. Recommended Practices for Safety and Health Programs. Available from: https://www.osha.gov/shpguidelines/docs/OSHA_SHP_Recommended_Practices.pdf
40. U.S. Department of Health & Human Services [Internet]. Washington (DC): Federal Experts Security Advisory Panel; c2017 [cited 2019 Jan 7]. Guiding Principles for Biosafety Governance: Ensuring Institutional Compliance with Biosafety, Biocontainment, and Laboratory Biosecurity Regulations and Guidelines. Available from: <https://www.phe.gov/s3/Documents/FESAP-guiding-principles.pdf>

Section III—Principles of Biosafety

A fundamental objective of any biosafety program is the containment of potentially hazardous biological agents and toxins. The term containment describes a combination of primary and secondary barriers, facility practices and procedures, and other safety equipment, including personal protective equipment (PPE), for managing the risks associated with handling and storing hazardous biological agents and toxins in a laboratory environment. The purpose of containment is to reduce the risk of exposure to staff and the unintentional release of hazardous biological agents or toxins into the surrounding community and environment. Final determination on the combination of containment measures required to address the relevant biosafety risk present at a facility should be based on a comprehensive biosafety risk assessment. A comprehensive biosafety risk assessment is a key component of a successful biosafety program and should be part of an all-hazards risk assessment; it should be conducted on a continual basis to address evolving risks within the laboratory environment. Detailed information on the biological risk assessment process is found in [Section II](#) of BMBL.

Management and leadership, with support from the facility's biosafety professionals and other health and safety personnel, must perform and review the risk assessment using the best available information. Management and leadership are responsible for assessing the risks and selecting the appropriate combination of risk mitigation measures. All persons in the institution are responsible for performing their work in a manner that ensures the successful implementation and performance of the safety measures identified in the risk assessment and review.

Safety Equipment (Primary Barriers)

Primary barrier or primary containment is defined as physical containment measure(s) placed directly at the level of the hazard. Safety equipment such as biological safety cabinets (BSCs), enclosed containers, and other biosafety controls are designed to protect personnel, the surrounding community, and the environment from possible exposure to hazardous biological agents and toxins. Primary barriers can function to either provide containment (e.g., BSCs) or direct personal protection from the hazardous biological agents and toxins used. The BSC is the standard device used to provide containment of hazardous biological agents and toxins when conducting microbiological activities. Three primary types of BSCs (Class I, II, III) are used in laboratory facilities and selection of the appropriate BSC should be based on the risks identified for each respective laboratory. The three classes of BSCs are described and illustrated in [Appendix A](#) of BMBL.

Additional primary containment devices may include sealed containers (e.g., sealed rotors and centrifuge safety cups). These enclosed containers

are designed to contain aerosols, droplets, and leakage of hazardous biological agents and toxins that may result during certain activities (e.g., centrifugation). Sealed containers provide containment for transfers between laboratories within a facility, between facilities, and depending upon risk assessment, within a laboratory. Selection of the appropriate primary containment device should be based on the risks identified for those activities likely to produce aerosols, droplets, or result in potential leakage of hazardous biological agents and toxins.

Note that in some cases, such as when working with large animals, secondary barriers may become primary barriers. This lack of traditional primary barriers (e.g., BSC) can lead to additional risks to personnel, the surrounding community, and the environment. In these cases, the facility becomes the primary barrier and personnel must rely on administrative and personal protective equipment to reduce the risk of exposure. This type of facility may require additional engineering controls and precautions (e.g., HEPA filtration on the exhaust air) to mitigate the risks posed to personnel, the surrounding community, and the environment.

Personal Protective Equipment

Personal protective equipment (PPE) helps protect the user's body from injury from a variety of sources (e.g., physical, electrical, heat, noise, chemical) or potential exposure to biological hazards and airborne particulate matter. PPE includes gloves, coats, gowns, shoe covers, closed-toe laboratory footwear, respirators, face shields, safety glasses, goggles, or ear plugs. PPE is usually used in combination with other biosafety controls (e.g., BSCs, centrifuge safety cups, and small animal caging systems) that contain the hazardous biological agents and toxins, animals, or materials being handled. In situations where a BSC cannot be used, PPE may become the primary barrier between personnel and the hazardous biological agents and toxins. Examples include fieldwork, resource-limited settings, certain animal studies, animal necropsy, and activities relating to operations, maintenance, service, or support of the laboratory facility. Selection of the appropriate PPE should be based on the risks identified for each respective laboratory.

Facility Design and Construction (Secondary Barriers)

The design and construction of the laboratory facility provide a means of secondary containment of hazardous biological agents and toxins. The secondary barriers, together with other biosafety controls, help provide protection of personnel, the surrounding community, and the environment from possible exposure to hazardous biological agents and toxins.

When the risk of infection by aerosol or droplet exposure is present, higher levels of secondary containment and multiple primary barriers may be used in combination with other controls to minimize the risk of exposure to personnel and the

unintentional release into the surrounding community or the environment. Such design features may include, but are not limited to the following:

- Ventilation strategies to ensure containment of the hazards;
- Effluent decontamination systems; and
- Specialized building/suite/laboratory configurations, including:
 - Controlled access zones to support the separation of the laboratory from office and public spaces;
 - Anterooms; and
 - Airlocks.

Design engineers may refer to specific ventilation recommendations as found in the American Society of Heating, Refrigerating and Air-Conditioning Engineers (ASHRAE) Laboratory Design Guide.¹ Please note that depending on the laboratory facility, design professionals may need to follow or consult with the current versions of additional design recommendations and requirements such as:

- The National Institutes of Health (NIH) Design Requirements Manual (DRM);
- World Health Organization (WHO) Laboratory Biosafety Manual;
- World Organization for Animal Health (OIE) Manual of Diagnostic Tests and Vaccines for Terrestrial Animals; and/or
- Other similar national or international design reference documents.

Facility Practices and Procedures

Established facility-specific best practices and procedures are essential to support the implementation and sustainability of a successful biosafety program. Persons working in facilities that handle and store hazardous biological agents and toxins must be able to properly identify all potential hazards and be trained and proficient in necessary safe practices and procedures. Management and leadership are responsible for providing and arranging the appropriate training of all personnel based on their functional roles and responsibilities in support of the biosafety program. Strict adherence to documented laboratory best practices and procedures is an essential element of a robust biosafety program since failure to follow the established procedures could result in an accidental exposure to personnel or unintentional release of hazardous biological agents and toxins into the surrounding community or the environment.

All facilities should develop and implement a biosafety program that identifies the hazards and specifies risk mitigation strategies to eliminate or reduce the likelihood of exposures and unintentional releases of hazardous materials. Management and leadership are ultimately responsible for the work conducted within laboratory facilities. When existing safety practices and procedures are not sufficient to minimize the risk(s) associated with a particular hazardous biological agent and/or toxin to an acceptable level, additional risk mitigation measures may

be needed. Safety best practices and procedures must be developed and implemented in coordination with other components of the overall biosafety program.

Biosafety Levels

The four primary Biosafety Levels (BSLs) for laboratories described in [Section IV](#) of BMBL consist of combinations of facility design features and safety equipment (primary and secondary barriers), facility practices and procedures, and personal protective equipment. Selection of the appropriate combinations to safely conduct the work should be based upon a comprehensive facility-specific biosafety risk assessment that documents the properties of the biological agents and toxins to be used, potential host characteristics, potential routes of infection, and the laboratory work practices and procedures conducted or anticipated to be used in the future. Recommended Biosafety Level(s) for the biological agents and toxins in [Section VIII](#) of BMBL represent suggested practices for work with an agent or toxin using standard protocols. Not all biological agents and toxins capable of causing disease in humans are included in [Section VIII](#).

When working with well-defined organisms, identification of the appropriate biosafety controls should be based on the comprehensive biosafety risk assessment. However, when information is available to suggest that virulence, pathogenicity, antibiotic resistance patterns, vaccine and treatment availability, or other factors are significantly altered, an adjustment to the stringency of biosafety controls may be needed. For example, handling large volumes or high concentrations of a biological agent or toxin may require additional practices outlined in [Sections IV](#) and [V](#) of BMBL. Similarly, procedures that produce large amounts of aerosols may also require additional biosafety controls to reduce the likelihood of exposures to personnel and the unintentional release of a biological agent or toxin in the surrounding community or the environment. Furthermore, vaccines should not be considered non-pathogenic simply because they are vaccine strains.

It is important to note that the four Biosafety Levels described below are not to be confused and equated with Agent Risk Groups as described in the *National Institutes of Health Guidelines for Research Involving Recombinant or Synthetic Nucleic Acid Molecules (NIH Guidelines)*. The Risk Group (RG) of an agent is an important factor to be considered during the biosafety risk assessment process. Biological agents and toxins are assigned to their relevant Risk Groups based on their ability to cause disease in healthy human adults and spread within the community. However, just because a biological agent is listed as a Risk Group 3 agent, it does not mean the activities conducted with that biological agent must occur in a BSL-3 laboratory.

Biosafety Level 1

Biosafety Level 1 (BSL-1) standard practices, safety equipment, and facility specifications are generally appropriate for undergraduate and secondary educational training and teaching laboratories and for other laboratories that work with defined and characterized strains of viable biological agents not known to consistently cause disease in healthy adult humans. *Bacillus subtilis*, *Naegleria gruberi*, infectious canine hepatitis virus, and exempt organisms under the *NIH Guidelines* are examples of the biological agents meeting these criteria. BSL-1 represents a basic level of containment that relies on standard, microbiological best practices and procedures with no special primary or secondary barriers, other than a door, a sink for handwashing, and non-porous work surfaces that are cleanable and easy to decontaminate.

Biosafety Level 2

Biosafety Level 2 (BSL-2) standard practices, safety equipment, and facility specifications are applicable to laboratories in which work is performed using a broad-spectrum of biological agents and toxins that are associated with causing disease in humans of varying severity. With good practices and procedures, these agents and toxins can generally be handled safely on an open bench, provided the potential for producing splashes and aerosols is low. Hepatitis B virus, human immunodeficiency virus (HIV), *Salmonella*, and *Toxoplasma* are examples of the biological agents that meet these criteria. Work done with any human, animal, or plant-derived specimens (e.g., blood, body fluids, tissues, or primary cell lines), where the presence of a biological agent or toxin may be unknown, can often be safely conducted under conditions typically associated with BSL-2.³⁻⁵ Personnel working with human-derived materials should refer to the OSHA Bloodborne Pathogens Standard for specific required precautions.²

The primary routes of exposure to personnel working with these types of biological agents and toxins relate to accidents including exposure via the percutaneous or mucosal routes and ingestion of potentially infectious materials. Extreme caution should be taken with contaminated needles and other sharp materials. Even though the biological agents and toxins routinely manipulated at BSL-2 are not known to be transmissible by the aerosol route, procedures with aerosol or high splash potential are conducted within primary containment equipment, such as a BSC or safety centrifuge cups. Furthermore, the use of primary containment equipment is also recommended when high-risk infectious agents are suspected to be present in any human, animal, or plant-derived specimens. Selection of the appropriate personal protective equipment should be based on the risks identified for each respective laboratory. Special practices for BSL-2 and ABSL-2 are recommended in [Sections IV](#) and [V](#).

Secondary barriers should include those previously mentioned for BSL-1. Waste decontamination capabilities to reduce the potential of environmental contamination and the separation of laboratory spaces from office and public spaces to reduce the risk of exposure to other personnel should be considered.

Biosafety Level 3

Biosafety Level 3 (BSL-3) standard practices, safety equipment, and facility specifications are applicable to laboratories in which work is performed using indigenous or exotic biological agents with a potential for respiratory transmission and those that may cause serious and potentially lethal infection. *Mycobacterium tuberculosis*, St. Louis encephalitis virus, and *Coxiella burnetii* are examples of the biological agents that meet these criteria.

The primary routes of exposure to personnel working with these types of biological agents and toxins relate to accidental exposure via the percutaneous or mucosal routes and inhalation of potentially infectious aerosols. At BSL-3, more emphasis is placed on primary and secondary barriers to protect personnel, the surrounding community, and the environment from exposure to potentially infectious aerosols. All procedures involving the manipulation of infectious materials are conducted within a BSC or other primary containment device. No work with open vessels is conducted on the bench. When a procedure cannot be performed within a BSC, a combination of personal protective equipment and other primary containment strategies (e.g., centrifuge safety cups, sealed rotors or softwall containment enclosures) are implemented based on a risk assessment. Loading and unloading of the rotors and centrifuge safety cups take place in the BSC or another containment device.

Secondary barriers for BSL-3 laboratories include those previously mentioned for BSL-1 and BSL-2 laboratories. They also include enhanced ventilation strategies to ensure inward directional airflow, controlled access zones to limit access to only laboratory approved personnel, and may contain anterooms, airlocks, exit showers, and/or exhaust HEPA filtration.

Biosafety Level 4

Biosafety Level 4 (BSL-4) standard practices, safety equipment, and facility specifications are applicable primarily for laboratories working with dangerous and exotic biological agents that pose a high individual risk of life-threatening disease that may be transmitted via the aerosol route and for which there is no available vaccine or therapy. Marburg virus and Congo-Crimean hemorrhagic fever virus are examples of the biological agents that meet these criteria. Agents with a close or identical antigenic relationship to agents requiring BSL-4 containment must be handled at this level until sufficient data are obtained either to confirm continued work at this level or to re-designate the level.

The primary routes of exposure to personnel working with these types of biological agents relate to accidental exposure via the percutaneous and mucous membrane routes and inhalation of potentially infectious aerosols. The laboratory worker's complete isolation from aerosolized infectious materials is accomplished primarily by working in a Class III BSC or in a Class II BSC with a full-body, air-supplied positive-pressure personnel suit.

Secondary barriers for BSL-4 laboratories should include those previously mentioned for previous Biosafety Levels. Additionally, the BSL-4 facility itself is often a separate building or completely isolated zone with complex, specialized ventilation requirements and waste management systems, for both solid and liquid waste, to prevent the release of hazardous biological agents into the surrounding community and the environment.

Animal Facilities

Four primary Biosafety Levels are also described for activities involving hazardous biological agent and toxin work conducted with animals. These four combinations of facility design and construction, safety equipment, and practices and procedures are designated Animal Biosafety Levels (ABSL) 1, 2, 3, and 4, and provide increasing levels of protection to personnel, the surrounding community, and the environment.

One additional Biosafety Level, designated Animal Biosafety Level 3-Agriculture (ABSL-3Ag) addresses activities involving the use of hazardous biological agents and toxins designated as High-Consequence Foreign Animal Diseases and Pests by the U.S. Department of Agriculture's (USDA) Animal and Plant Health Inspection Service (APHIS) in large or loose-housed animals. ABSL-3Ag laboratories are designed so that the laboratory building itself serves as a primary barrier to prevent the unintentional release of these high consequence agents into the environment. More information on the design and operation of ABSL-3Ag facilities and USDA/APHIS High-Consequence Foreign Animal Diseases and Pests is provided in [Appendix D](#) of BMBL. [Appendix D](#) also provides guidance for containment of loose-housed or open penned animals at other containment levels, designated ABSL-2Ag and ABSL-4Ag.

Clinical Laboratories

Clinical laboratories routinely work with unknown specimens and specimens that have the potential to be infected with multiple pathogens; as such, the occupational risks in a clinical laboratory environment differ from those of a research or teaching laboratory. Most public and animal health clinical laboratories use Biosafety Level 2 (BSL-2) facility, engineering, and biosafety practices.⁵ Clinical diagnostic laboratory personnel may not know what infectious agent or other hazard(s) exist in the specimen they handle and process. More information on clinical laboratory biosafety is provided in [Appendix N](#).

Laboratory Biosecurity

In recent years, with the passing of federal legislation regulating the possession, use, and transfer of biological Select Agents and Toxins with high adverse public health and/or agricultural consequences (DHHS, USDA APHIS Select Agents), a much greater emphasis has been placed in the emerging field of biosecurity. Biosecurity and Select Agent issues are covered in detail in [Section VI](#) and [Appendix F](#) of BMBL. While biosafety focuses on the protection of personnel, the surrounding community, and the environment from the unintentional release of hazardous biological agents and toxins, the field of laboratory biosecurity is focused on the prevention of the theft, loss, and misuse of hazardous biological agents and toxins, equipment, and/or valuable information by an individual(s) for malicious use. Nonetheless, a successful containment strategy must incorporate aspects of both biosafety and laboratory biosecurity to adequately address the risks present at the facility.

References

1. American Society of Heating, Refrigerating and Air-Conditioning Engineers. ASHRAE Laboratory Design Guide: Planning and Operation of Laboratory HVAC Systems. 2nd ed. Atlanta (GA): ASHRAE; 2015.
2. Bloodborne pathogens, 29 C.F.R. Part 1910.1030 (1992).
3. Centers for Disease Control and Prevention. Update: universal precautions for prevention of transmission of human immunodeficiency virus, hepatitis B virus, and other bloodborne pathogens in health-care settings. *MMWR Morb Mortal Wkly Rep.* 1988;37(24):377–82, 387–8.
4. Garner JS. Guideline for isolation precautions in hospitals. The Hospital Infection Control Practices Advisory Committee. *Infect Control Hosp Epidemiol.* 1996;17(1):53–80. Erratum in: *Infect Control Hosp Epidemiol.* 1996;17(4):214.
5. CLSI. Protection of Laboratory Workers from Occupationally Acquired Infections: Approved Guideline—Fourth Edition. CLSI document M29-A4. Wayne (PA): Clinical and Laboratory Standards Institute; 2014.

Section IV—Laboratory Biosafety Level Criteria

The essential elements of the Biosafety Levels 1–4 are standard microbiological practices, special practices, safety equipment, and laboratory facilities as discussed in [Section III](#); these elements apply to activities involving infectious microorganisms, toxins, and laboratory animals. The four levels are organized in ascending order by the degree of protection provided to personnel, the environment, and the community. Special practices address any unique risks associated with the handling of agents requiring increasing levels of containment. Appropriate safety equipment and laboratory facilities enhance worker and environmental protection.

The features of each Biosafety Level (BSL) are summarized in Table 1 of this section. Adjustments to the containment levels described are based on an assessment of all risks, as detailed in [Section II](#). Each facility ensures that worker safety and health concerns are coordinated with the Institutional Biosafety Committee (IBC), or equivalent resource, and/or other applicable institutional safety committee(s) and that all hazards are addressed as part of the protocol review process. Additional occupational health information is provided in [Section VII](#).

Biosafety Level 1

Biosafety Level 1 (BSL-1) is suitable for work involving well-characterized agents not known to consistently cause disease in immunocompetent adult humans and that present minimal potential hazard to laboratory personnel and the environment. BSL-1 laboratories are not necessarily separated from the general traffic patterns in the building. Work is typically conducted on open benchtops using standard microbiological practices. Special containment equipment or facility design is not generally required but may be used as determined by appropriate risk assessment. Laboratory personnel receive specific training in the procedures conducted in the laboratory and are supervised by a scientist with training in microbiology or a related science.

The following standard practices, safety equipment, and facility specifications are recommended for BSL-1.

A. Standard Microbiological Practices

1. The laboratory supervisor enforces the institutional policies that control safety in and access to the laboratory.
2. The laboratory supervisor ensures that laboratory personnel receive appropriate training regarding their duties, potential hazards, manipulations of infectious agents, necessary precautions to minimize exposures, and hazard/exposure evaluation procedures (e.g., physical hazards, splashes, aerosolization) and that appropriate records are maintained.

Personnel receive annual updates and additional training when equipment, procedures, or policies change. All persons entering the facility are advised of the potential hazards, are instructed on the appropriate safeguards, and read and follow instructions on practices and procedures. An institutional policy regarding visitor training, occupational health requirements, and safety communication is considered.

3. Personal health status may affect an individual's susceptibility to infection and ability to receive available immunizations or prophylactic interventions. Therefore, all personnel, and particularly those of reproductive age and/or those having conditions that may predispose them to increased risk for infection (e.g., organ transplant, medical immunosuppressive agents), are provided information regarding immune competence and susceptibility to infectious agents. Individuals having such conditions are encouraged to self-identify to the institution's healthcare provider for appropriate counseling and guidance. See [Section VII](#).
4. A safety manual specific to the facility is prepared or adopted in consultation with the facility director and appropriate safety professionals. The safety manual is available, accessible, and periodically reviewed and updated, as necessary.
 - a. The safety manual contains sufficient information to describe the biosafety and containment procedures for the organisms and biological materials in use, appropriate agent-specific decontamination methods, and the work performed.
 - b. The safety manual contains or references protocols for emergency situations, including exposures, medical emergencies, facility malfunctions, and other potential emergencies. Training in emergency response procedures is provided to emergency response personnel and other responsible staff according to institutional policies.
5. A sign is posted at the entrance to the laboratory when infectious materials are present. Posted information includes: the laboratory's Biosafety Level, the supervisor's or other responsible personnel's name and telephone number, PPE requirements, general occupational health requirements (e.g., immunizations, respiratory protection), and required procedures for entering and exiting the laboratory. Agent information is posted in accordance with the institutional policy.
6. Long hair is restrained so that it cannot contact hands, specimens, containers, or equipment.

7. Gloves are worn to protect hands from exposure to hazardous materials.
 - a. Glove selection is based on an appropriate risk assessment.
 - b. Gloves are not worn outside the laboratory.
 - c. Change gloves when contaminated, glove integrity is compromised, or when otherwise necessary.
 - d. Do not wash or reuse disposable gloves, and dispose of used gloves with other contaminated laboratory waste.
8. Gloves and other PPE are removed in a manner that minimizes personal contamination and transfer of infectious materials outside of the areas where infectious materials and/or animals are housed or manipulated.
9. Persons wash their hands after working with potentially hazardous materials and before leaving the laboratory.
10. Eating, drinking, smoking, handling contact lenses, applying cosmetics, and storing food for human consumption are not permitted in laboratory areas. Food is stored outside the laboratory area.
11. Mouth pipetting is prohibited. Mechanical pipetting devices are used.
12. Policies for the safe handling of sharps, such as needles, scalpels, pipettes, and broken glassware are developed, implemented, and followed; policies are consistent with applicable state, federal, and local requirements. Whenever practical, laboratory supervisors adopt improved engineering and work practice controls that reduce risk of sharps injuries. Precautions are always taken with sharp items. These include:
 - a. Plasticware is substituted for glassware whenever possible.
 - b. Use of needles and syringes or other sharp instruments is limited in the laboratory and is restricted to situations where there is no alternative (e.g., parenteral injection, blood collection, or aspiration of fluids from laboratory animals or diaphragm bottles). Active or passive needle-based safety devices are to be used whenever possible.
 - i. Uncapping of needles is performed in such a manner to reduce the potential for recoil causing an accidental needlestick.
 - ii. Needles are not bent, sheared, broken, recapped, removed from disposable syringes, or otherwise manipulated by hand before disposal.
 - iii. If absolutely necessary to remove a needle from a syringe (e.g., to prevent lysing blood cells) or recap a needle

- (e.g., loading syringes in one room and injecting animals in another), a hands-free device or comparable safety procedure must be used (e.g., a needle remover on a sharps container, the use of forceps to hold the cap when recapping a needle).
- iv. Used, disposable needles and syringes are carefully placed in puncture-resistant containers used for sharps disposal immediately after use. The sharps disposal container is located as close to the point of use as possible.
 - c. Non-disposable sharps are placed in a hard-walled container for transport to a processing area for decontamination, preferably by autoclaving.
 - d. Broken glassware is not handled directly. Instead, it is removed using a brush and dustpan, tongs, or forceps.
13. Perform all procedures to minimize the creation of splashes and/or aerosols.
 14. Decontaminate work surfaces after completion of work and after any spill or splash of potentially infectious material with appropriate disinfectant. Spills involving infectious materials are contained, decontaminated, and cleaned up by staff who are properly trained and equipped to work with infectious material. A spill procedure is developed and posted within the laboratory.
 15. Decontaminate all cultures, stocks, and other potentially infectious materials before disposal using an effective method, consistent with applicable institutional, local, and state requirements. Depending on where the decontamination will be performed, the following methods are used prior to transport:
 - a. Materials to be decontaminated outside of the immediate laboratory are placed in a durable, leak-proof container and secured for transport. For infectious materials, the outer surface of the container is disinfected prior to moving materials and the transport container has a universal biohazard label.
 - b. Materials to be removed from the facility for decontamination are packed in accordance with applicable local, state, and federal regulations.
 16. An effective integrated pest management program is implemented. See [Appendix G](#).
 17. Animals and plants not associated with the work being performed are not permitted in the laboratory.

B. Special Practices

None required.

C. Safety Equipment (Primary Barriers and Personal Protective Equipment)

1. Special containment devices or equipment, such as biosafety cabinets (BSCs), are not generally required.
2. Protective laboratory coats, gowns, or uniforms are worn to prevent contamination of personal clothing.
3. Protective eyewear is worn by personnel when conducting procedures that have the potential to create splashes and sprays of microorganisms or other hazardous materials. Eye protection and face protection are disposed of with other contaminated laboratory waste or decontaminated after use.
4. In circumstances where research animals are present in the laboratory, the risk assessment considers appropriate eye, face, and respiratory protection, as well as potential animal allergens.

D. Laboratory Facilities (Secondary Barriers)

1. Laboratories have doors for access control.
2. Laboratories have a sink for handwashing.
3. An eyewash station is readily available in the laboratory.
4. The laboratory is designed so that it can be easily cleaned.
 - a. Carpets and rugs in laboratories are not appropriate.
 - b. Spaces between benches, cabinets, and equipment are accessible for cleaning.
5. Laboratory furniture can support anticipated loads and uses.
 - a. Benchtops are impervious to water and resistant to heat, organic solvents, acids, alkalis, and other chemicals.
 - b. Chairs used in laboratory work are covered with a non-porous material that can be easily cleaned and decontaminated with appropriate disinfectant.
6. Laboratory windows that open to the exterior are fitted with screens.
7. Illumination is adequate for all activities and avoids reflections and glare that could impede vision.

Biosafety Level 2

Biosafety Level 2 (BSL-2) builds upon BSL-1. BSL-2 is suitable for work with agents associated with human disease and pose moderate hazards to personnel and the environment. BSL-2 differs from BSL-1 primarily because: 1) laboratory personnel receive specific training in handling pathogenic agents and are supervised by scientists competent in handling infectious agents and associated procedures; 2) access to the laboratory is restricted when work is being conducted; and 3) all procedures in which infectious aerosols or splashes may be created are conducted in BSCs or other physical containment equipment.

The following standard and special practices, safety equipment, and facility specifications are recommended for BSL-2.

A. Standard Microbiological Practices

1. The laboratory supervisor enforces the institutional policies that control safety in and access to the laboratory.
2. The laboratory supervisor ensures that laboratory personnel receive appropriate training regarding their duties, potential hazards, manipulations of infectious agents, necessary precautions to minimize exposures, and hazard/exposure evaluation procedures (e.g., physical hazards, splashes, aerosolization) and that appropriate records are maintained. Personnel receive annual updates and additional training when equipment, procedures, or policies change. All persons entering the facility are advised of the potential hazards, are instructed on the appropriate safeguards, and read and follow instructions on practices and procedures. An institutional policy regarding visitor training, occupational health requirements, and safety communication is considered.
3. Personal health status may affect an individual's susceptibility to infection and ability to receive available immunizations or prophylactic interventions. Therefore, all personnel, and particularly those of reproductive age and/or those having conditions that may predispose them to increased risk for infection (e.g., organ transplant, medical immunosuppressive agents), are provided information regarding immune competence and susceptibility to infectious agents. Individuals having such conditions are encouraged to self-identify to the institution's healthcare provider for appropriate counseling and guidance. See [Section VII](#).
4. A safety manual specific to the facility is prepared or adopted in consultation with the facility director and appropriate safety professionals. The safety manual is available, accessible, and periodically reviewed and updated as necessary.

- a. The safety manual contains sufficient information to describe the biosafety and containment procedures for the organisms and biological materials in use, appropriate agent-specific decontamination methods, and the work performed.
 - b. The safety manual contains or references protocols for emergency situations, including exposures, medical emergencies, facility malfunctions, and other potential emergencies. Training in emergency response procedures is provided to emergency response personnel and other responsible staff according to institutional policies.
5. A sign incorporating the universal biohazard symbol is posted at the entrance to the laboratory when infectious materials are present. Posted information includes: the laboratory's Biosafety Level, the supervisor's or other responsible personnel's name and telephone number, PPE requirements, general occupational health requirements (e.g., immunizations, respiratory protection), and required procedures for entering and exiting the laboratory. Agent information is posted in accordance with the institutional policy.
 6. Long hair is restrained so that it cannot contact hands, specimens, containers, or equipment.
 7. Gloves are worn to protect hands from exposure to hazardous materials.
 - a. Glove selection is based on an appropriate risk assessment.
 - b. Gloves are not worn outside the laboratory.
 - c. Change gloves when contaminated, glove integrity is compromised, or when otherwise necessary.
 - d. Do not wash or reuse disposable gloves, and dispose of used gloves with other contaminated laboratory waste.
 8. Gloves and other PPE are removed in a manner that minimizes personal contamination and transfer of infectious materials outside of the areas where infectious materials and/or animals are housed or manipulated.
 9. Persons wash their hands after working with potentially hazardous materials and before leaving the laboratory.
 10. Eating, drinking, smoking, handling contact lenses, applying cosmetics, and storing food for human consumption are not permitted in laboratory areas. Food is stored outside the laboratory area.
 11. Mouth pipetting is prohibited. Mechanical pipetting devices are used.

12. Policies for the safe handling of sharps, such as needles, scalpels, pipettes, and broken glassware are developed, implemented, and followed; policies are consistent with applicable state, federal, and local requirements. Whenever practical, laboratory supervisors adopt improved engineering and work practice controls that reduce risk of sharps injuries. Precautions are always taken with sharp items. These include:
 - a. Plasticware is substituted for glassware whenever possible.
 - b. Use of needles and syringes or other sharp instruments is limited in the laboratory and is restricted to situations where there is no alternative (e.g., parenteral injection, blood collection, or aspiration of fluids from laboratory animals or diaphragm bottles). Active or passive needle-based safety devices are to be used whenever possible.
 - i. Uncapping of needles is performed in such a manner to reduce the potential for recoil causing an accidental needlestick.
 - ii. Needles are not bent, sheared, broken, recapped, removed from disposable syringes, or otherwise manipulated by hand before disposal.
 - iii. If absolutely necessary to remove a needle from a syringe (e.g., to prevent lysing blood cells) or recap a needle (e.g., loading syringes in one room and injecting animals in another), a hands-free device or comparable safety procedure must be used (e.g., a needle remover on a sharps container, the use of forceps to hold the cap when recapping a needle).
 - iv. Used, disposable needles and syringes are carefully placed in puncture-resistant containers used for sharps disposal immediately after use. The sharps disposal container is located as close to the point of use as possible.
 - c. Non-disposable sharps are placed in a hard-walled container for transport to a processing area for decontamination, preferably by autoclaving.
 - d. Broken glassware is not handled directly. Instead, it is removed using a brush and dustpan, tongs, or forceps.
13. Perform all procedures to minimize the creation of splashes and/or aerosols.

14. Decontaminate work surfaces after completion of work and after any spill or splash of potentially infectious material with appropriate disinfectant. Spills involving infectious materials are contained, decontaminated, and cleaned up by staff who are properly trained and equipped to work with infectious material. A spill procedure is developed and posted within the laboratory.
15. Decontaminate all cultures, stocks, and other potentially infectious materials before disposal using an effective method, consistent with applicable institutional, local, and state requirements. Depending on where the decontamination will be performed, the following methods are used prior to transport:
 - a. Materials to be decontaminated outside of the immediate laboratory are placed in a durable, leak-proof container and secured for transport. For infectious materials, the outer surface of the container is disinfected prior to moving materials and the transport container has a universal biohazard label.
 - b. Materials to be removed from the facility for decontamination are packed in accordance with applicable local, state, and federal regulations.
16. An effective integrated pest management program is implemented. See [Appendix G](#).
17. Animals and plants not associated with the work being performed are not permitted in the laboratory.

B. Special Practices

1. Access to the laboratory is controlled when work is being conducted.
2. The laboratory supervisor is responsible for ensuring that laboratory personnel demonstrate proficiency in standard microbiological practices and techniques for working with agents requiring BSL-2 containment.
3. Laboratory personnel are provided medical surveillance, as appropriate, and offered available immunizations for agents handled or potentially present in the laboratory.
4. Properly maintained BSCs or other physical containment devices are used, when possible, whenever:
 - a. Procedures with a potential for creating infectious aerosols or splashes are conducted. These include pipetting, centrifuging, grinding, blending, shaking, mixing, sonicating, opening containers of infectious materials, inoculating animals intranasally, and harvesting infected tissues from animals or eggs.

- b. High concentrations or large volumes of infectious agents are used. Such materials may be centrifuged in the open laboratory using sealed rotors or centrifuge safety cups with loading and unloading of the rotors and centrifuge safety cups in the BSC or another containment device.
 - c. If it is not possible to perform a procedure within a BSC or other physical containment device, a combination of appropriate personal protective equipment and administrative controls are used, based on a risk assessment.
- 5. Laboratory equipment is decontaminated routinely; after spills, splashes, or other potential contamination; and before repair, maintenance, or removal from the laboratory.
 - 6. A method for decontaminating all laboratory waste is available (e.g., autoclave, chemical disinfection, incineration, or other validated decontamination method).
 - 7. Incidents that may result in exposure to infectious materials are immediately evaluated per institutional policies. All such incidents are reported to the laboratory supervisor and any other personnel designated by the institution. Appropriate records are maintained.

C. Safety Equipment (Primary Barriers and Personal Protective Equipment).

- 1. Protective laboratory coats, gowns, or uniforms designated for laboratory use are worn while working with hazardous materials and removed before leaving for non-laboratory areas (e.g., cafeteria, library, and administrative offices). Protective clothing is disposed of appropriately or deposited for laundering by the institution. Laboratory clothing is not taken home.
- 2. Eye protection and face protection (e.g., safety glasses, goggles, mask, face shield or other splatter guard) are used for manipulations or activities that may result in splashes or sprays of infectious or other hazardous materials. Eye protection and face protection are disposed of with other contaminated laboratory waste or decontaminated after use.
- 3. The risk assessment considers whether respiratory protection is needed for the work with hazardous materials. If needed, relevant staff are enrolled in a properly constituted respiratory protection program.
- 4. In circumstances where research animals are present in the laboratory, the risk assessment considers appropriate eye, face, and respiratory protection, as well as potential animal allergens.

D. Laboratory Facilities (Secondary Barriers)

1. Laboratory doors are self-closing and have locks in accordance with the institutional policies.
2. Laboratories have a sink for handwashing. It should be located near the exit door.
3. An eyewash station is readily available in the laboratory.
4. The laboratory is designed so that it can be easily cleaned.
 - a. Carpets and rugs in laboratories are not appropriate.
 - b. Spaces between benches, cabinets, and equipment are accessible for cleaning.
5. Laboratory furniture can support anticipated loads and uses.
 - a. Benchtops are impervious to water and resistant to heat, organic solvents, acids, alkalis, and other chemicals.
 - b. Chairs used in laboratory work are covered with a non-porous material that can be easily cleaned and decontaminated with appropriate disinfectant.
6. Laboratory windows that open to the exterior are not recommended. However, if a laboratory does have windows that open to the exterior, they are fitted with screens.
7. Illumination is adequate for all activities and avoids reflections and glare that could impede vision.
8. Vacuum lines in use are protected with liquid disinfectant traps and in-line HEPA filters or their equivalent. See [Appendix A, Figure 11](#). Filters are replaced, as needed, or are on a replacement schedule determined by a risk assessment.
9. There are no specific requirements for ventilation systems. However, the planning of new facilities considers mechanical ventilation systems that provide an inward flow of air without recirculation to spaces outside of the laboratory.
10. BSCs and other primary containment barrier systems are installed and operated in a manner to ensure their effectiveness. See [Appendix A](#).
 - a. BSCs are installed so that fluctuations of the room air supply and exhaust do not interfere with proper operations. BSCs are located away from doors, windows that can be opened, heavily traveled laboratory areas, and other possible airflow disruptions.

- b. BSCs can be connected to the laboratory exhaust system by either a canopy connection (Class IIA only) or directly exhausted to the outside through a hard connection (Class IIB, IIC, or III). Class IIA or IIC BSC exhaust can be safely recirculated back into the laboratory environment if no volatile toxic chemicals are used in the cabinet.
- c. BSCs are certified at least annually to ensure correct performance, or as specified in [Appendix A, Part 7](#).

Biosafety Level 3

Biosafety Level 3 (BSL-3) is suitable for work with indigenous or exotic agents that may cause serious or potentially lethal disease through the inhalation route of exposure. Laboratory personnel receive specific training in handling pathogenic and potentially lethal agents, and they are supervised by scientists competent in handling infectious agents and associated procedures.

A BSL-3 laboratory has special engineering and design features.

The following standard and special practices, safety equipment, and facility specifications are recommended for BSL-3.

A. Standard Microbiological Practices

1. The laboratory supervisor enforces the institutional policies that control safety in and access to the laboratory.
2. The laboratory supervisor ensures that laboratory personnel receive appropriate training regarding their duties, potential hazards, manipulations of infectious agents, necessary precautions to minimize exposures, and hazard/exposure evaluation procedures (e.g., physical hazards, splashes, aerosolization) and that appropriate records are maintained. Personnel receive annual updates and additional training when equipment, procedures, or policies change. All persons entering the facility are advised of the potential hazards, are instructed on the appropriate safeguards, and read and follow instructions on practices and procedures. An institutional policy regarding visitor training, occupational health requirements, and safety communication is considered.
3. Personal health status may affect an individual's susceptibility to infection and ability to receive available immunizations or prophylactic interventions. Therefore, all personnel, and particularly those of reproductive age and/or those having conditions that may predispose them to increased risk for infection (e.g., organ transplant, medical immunosuppressive agents), are provided information regarding immune competence and susceptibility to infectious agents. Individuals having

such conditions are encouraged to self-identify to the institution's healthcare provider for appropriate counseling and guidance. See [Section VII](#).

4. A safety manual specific to the facility is prepared or adopted in consultation with the facility director and appropriate safety professionals. The safety manual is available, accessible, and periodically reviewed and updated as necessary.
 - a. The safety manual contains sufficient information to describe the biosafety and containment procedures for the organisms and biological materials in use, appropriate agent-specific decontamination methods, and the work performed.
 - b. The safety manual contains or references protocols for emergency situations, including exposures, medical emergencies, facility malfunctions, and other potential emergencies. Training in emergency response procedures is provided to emergency response personnel and other responsible staff according to institutional policies.
5. A sign incorporating the universal biohazard symbol is posted at the entrance to the laboratory when infectious materials are present. Posted information includes: the laboratory's Biosafety Level, the supervisor's or other responsible personnel's name and telephone number, PPE requirements, general occupational health requirements (e.g., immunizations, respiratory protection), and required procedures for entering and exiting the laboratory. Agent information is posted in accordance with the institutional policy.
6. Long hair is restrained so that it cannot contact hands, specimens, containers, or equipment.
7. Gloves are worn to protect hands from exposure to hazardous materials.
 - a. Glove selection is based on an appropriate risk assessment.
 - b. Gloves are not worn outside the laboratory.
 - c. Change gloves when contaminated, glove integrity is compromised, or when otherwise necessary.
 - d. Do not wash or reuse disposable gloves and dispose of used gloves with other contaminated laboratory waste.
8. Gloves and other PPE are removed in a manner that minimizes personal contamination and transfer of infectious materials outside of the areas where infectious materials and/or animals are housed or manipulated.

9. Persons wash their hands after working with potentially hazardous materials and before leaving the laboratory.
10. Eating, drinking, smoking, handling contact lenses, applying cosmetics, and storing food for human consumption are not permitted in laboratory areas. Food is stored outside the laboratory area.
11. Mouth pipetting is prohibited. Mechanical pipetting devices are used.
12. Policies for the safe handling of sharps, such as needles, scalpels, pipettes, and broken glassware are developed, implemented, and followed; policies are consistent with applicable state, federal, and local requirements. Whenever practical, laboratory supervisors adopt improved engineering and work practice controls that reduce risk of sharps injuries. Precautions are always taken with sharp items. These include:
 - a. Plasticware is substituted for glassware whenever possible.
 - b. Use of needles and syringes or other sharp instruments is limited in the laboratory and is restricted to situations where there is no alternative (e.g., parenteral injection, blood collection, or aspiration of fluids from laboratory animals or diaphragm bottles). Active or passive needle-based safety devices are to be used whenever possible.
 - i. Uncapping of needles is performed in such a manner to reduce the potential for recoil causing an accidental needlestick.
 - ii. Needles are not bent, sheared, broken, recapped, removed from disposable syringes, or otherwise manipulated by hand before disposal.
 - iii. If absolutely necessary to remove a needle from a syringe (e.g., to prevent lysing blood cells) or recap a needle (e.g., loading syringes in one room and injecting animals in another), a hands-free device or comparable safety procedure must be used (e.g., a needle remover on a sharps container, the use of forceps to hold the cap when recapping a needle).
 - iv. Used, disposable needles and syringes are carefully placed in puncture-resistant containers used for sharps disposal immediately after use. The sharps disposal container is located as close to the point of use as possible.
 - c. Non-disposable sharps are placed in a hard-walled container for transport to a processing area for decontamination, preferably by autoclaving.

- d. Broken glassware is not handled directly. Instead, it is removed using a brush and dustpan, tongs, or forceps.
13. Perform all procedures to minimize the creation of splashes and/or aerosols.
14. Decontaminate work surfaces after completion of work and after any spill or splash of potentially infectious material with appropriate disinfectant. Spills involving infectious materials are contained, decontaminated, and cleaned up by staff who are properly trained and equipped to work with infectious material. A spill procedure is developed and posted within the laboratory.
15. Decontaminate all cultures, stocks, and other potentially infectious materials before disposal using an effective method, consistent with applicable institutional, local, and state requirements. Depending on where the decontamination will be performed, the following methods are used prior to transport:
 - a. Materials to be decontaminated outside of the immediate laboratory are placed in a durable, leak-proof container and secured for transport. For infectious materials, the outer surface of the container is disinfected prior to moving materials and the transport container has a universal biohazard label.
 - b. Materials to be removed from the facility for decontamination are packed in accordance with applicable local, state, and federal regulations.
16. An effective integrated pest management program is implemented. See [Appendix G](#).
17. Animals and plants not associated with the work being performed are not permitted in the laboratory.

B. Special Practices

1. All persons entering the laboratory are advised of the potential hazards and meet specific entry/exit requirements in accordance with institutional policies. Only persons whose presence in the facility or laboratory areas is required for scientific or support purposes are authorized to enter.
2. All persons who enter operational laboratory areas are provided information on signs and symptoms of disease and receive occupational medical services including medical evaluation, surveillance, and treatment, as appropriate, and offered available immunizations for agents handled or potentially present in the laboratory.

3. The laboratory supervisor is responsible for ensuring that laboratory personnel demonstrate proficiency in standard microbiological practices and techniques for working with agents requiring BSL-3 containment.
4. A system is established for reporting and documenting near misses, laboratory accidents, exposures, unanticipated absences due to potential Laboratory-associated infection, and for the medical surveillance of potential laboratory-associated illnesses.
5. Incidents that result in exposure to infectious materials are immediately evaluated per institutional policy. All such incidents are reported to the laboratory supervisor, institutional management, and appropriate safety, compliance, and security personnel according to institutional policy. Appropriate records are maintained.
6. Biological materials that require BSL-3 containment are placed in a durable leak-proof sealed primary container and then enclosed in a non-breakable, sealed secondary container prior to removal from the laboratory. Once removed, the primary container is opened within a BSC in BSL-3 containment unless a validated inactivation method is used. See [Appendix K](#). The inactivation method is documented in-house with viability testing data to support the method.
7. All procedures involving the manipulation of infectious materials are conducted within a BSC or other physical containment device, when possible. No work with open vessels is conducted on the bench. If it is not possible to perform a procedure within a BSC or other physical containment device, a combination of personal protective equipment and other administrative and/or engineering controls, such as centrifuge safety cups or sealed rotors, are used, based on a risk assessment. Loading and unloading of the rotors and centrifuge safety cups take place in the BSC or another containment device.
8. Laboratory equipment is routinely decontaminated after spills, splashes, or other potential contamination, and before repair, maintenance, or removal from the laboratory.
 - a. Equipment or material that might be damaged by high temperatures or steam is decontaminated using an effective and verified method, such as a gaseous or vapor method.
9. A method for decontaminating all laboratory waste is available in the facility, preferably within the laboratory (e.g., autoclave, chemical disinfection, or other validated decontamination method).

10. Decontamination of the entire laboratory is considered when there has been gross contamination of the space, significant changes in laboratory usage, major renovations, or maintenance shutdowns. Selection of the appropriate materials and methods used to decontaminate the laboratory is based on a risk assessment.
11. Decontamination processes are verified on a routine basis.

C. Safety Equipment (Primary Barriers and Personal Protective Equipment)

1. Laboratory workers wear protective clothing with a solid-front, such as tie-back or wrap-around gowns, scrub suits, or coveralls. Protective clothing is not worn outside of the laboratory. Reusable clothing is decontaminated before being laundered. Clothing is changed when contaminated.
2. Based on work being performed, additional PPE may be required.
 - a. Eye protection and face protection (e.g., safety glasses, goggles, mask, face shield or other splash guard) are used for manipulations or activities that may result in splashes or sprays of infectious or other hazardous materials. Eye protection and face protection are disposed of with other contaminated laboratory waste or decontaminated after use.
 - b. Two pairs of gloves are worn when appropriate.
 - c. Respiratory protection is considered. Staff wearing respiratory protection are enrolled in a properly constituted respiratory protection program.
 - d. Shoe covers are considered.
3. In circumstances where research animals are present in the laboratory, the risk assessment considers appropriate eye, face, and respiratory protection, as well as potential animal allergens.

D. Laboratory Facilities (Secondary Barriers)

1. The laboratory is separated from areas that are open to unrestricted traffic flow within the building.
 - a. Laboratory access is restricted. Laboratory doors are lockable in accordance with institutional policies. Access to the laboratory is through two consecutive self-closing doors. A clothing change room and/or an anteroom may be included in the passageway between the two self-closing doors.
2. Laboratories have a sink for handwashing. The sink is hands-free or automatically operated and should be located near the exit door.

If a laboratory suite is segregated into different zones, a sink is also available for handwashing in each zone.

3. An eyewash station is readily available in the laboratory.
4. The laboratory is designed, constructed, and maintained to facilitate cleaning, decontamination, and housekeeping.
 - a. Carpets and rugs are not permitted.
 - b. Spaces between benches, cabinets, and equipment are accessible for cleaning.
 - c. Seams, floors, walls, and ceiling surfaces are sealed. Spaces around doors and ventilation openings are capable of being sealed to facilitate space decontamination.
 - d. Floors are slip-resistant, impervious to liquids, and resistant to chemicals. Flooring is seamless, sealed, or poured with integral cove bases.
 - e. Walls and ceilings are constructed to produce a sealed smooth finish that can be easily cleaned and decontaminated.
5. Laboratory furniture can support anticipated loads and uses.
 - a. Benchtops are impervious to water and resistant to heat, organic solvents, acids, alkalis, and other chemicals.
 - b. Chairs used in laboratory work are covered with a non-porous material that can be easily cleaned and decontaminated with an appropriate disinfectant.
6. All windows in the laboratory are sealed.
7. Illumination is adequate for all activities and avoids reflections and glare that could impede vision.
8. Vacuum lines in use are protected with liquid disinfectant traps and in-line HEPA filters or their equivalent. See [Appendix A, Figure 11](#). Filters are replaced, as needed, or are on a replacement schedule determined by a risk assessment. Vacuum lines not protected as described are capped. The placement of an additional HEPA filter immediately prior to a central vacuum pump is considered.
9. A ducted mechanical air ventilation system is required. This system provides sustained directional airflow by drawing air into the laboratory from “clean” areas toward “potentially contaminated” areas. The laboratory is designed such that under failure conditions the airflow will not be reversed at the containment barrier.

- a. A visual monitoring device that confirms directional airflow is provided at the laboratory entry. Audible alarms to notify personnel of airflow disruption are considered.
 - b. The laboratory exhaust air is not re-circulated to any other area in the building.
 - c. The laboratory exhaust air is dispersed away from occupied areas and from building air intake locations or the exhaust air is HEPA filtered.
10. BSCs and other primary containment barrier systems are installed and operated in a manner to ensure their effectiveness. See [Appendix A](#).
- a. BSCs are installed so that fluctuations of the room air supply and exhaust do not interfere with proper operations. BSCs are located away from doors, heavily traveled laboratory areas, and other possible airflow disruptions.
 - b. BSCs can be connected to the laboratory exhaust system by either a canopy connection (Class IIA only) or directly exhausted to the outside through a hard connection (Class IIB, IIC, or III). Class IIA or IIC BSC exhaust can be safely recirculated back into the laboratory environment if no volatile toxic chemicals are used in the cabinet.
 - c. BSCs are certified at least annually to ensure correct performance, or as specified in [Appendix A, Part 7](#).
 - d. Class III BSCs are provided supply air in such a manner that prevents positive pressurization of the cabinet or the room.
11. Equipment that may produce infectious aerosols is used within primary barrier devices that exhaust air through HEPA filtration or other equivalent technology before being discharged into the laboratory. These HEPA filters are tested annually and replaced as needed.
12. Facility is constructed to allow decontamination of the entire laboratory when there has been gross contamination of the space, significant changes in usage, major renovations, or maintenance shutdowns. Selection of the appropriate materials and methods used to decontaminate the laboratory is based on the risk assessment.
- a. Facility design consideration is given to means of decontaminating large pieces of equipment before removal from the laboratory.
13. Enhanced environmental and personal protection may be necessary based on risk assessment and applicable local, state, or federal regulations. These laboratory enhancements may include one or more of the following: an anteroom for clean storage of equipment and supplies

with dress-in, shower-out capabilities; gas-tight dampers to facilitate laboratory isolation; final HEPA filtration of the laboratory exhaust air; laboratory effluent decontamination; containment of other piped services; or advanced access control devices, such as biometrics.

14. When present, HEPA filter housings have gas-tight isolation dampers, decontamination ports, and/or bag-in/bag-out (with appropriate decontamination procedures) capability. All HEPA filters are located as near as practicable to the laboratory to minimize the length of potentially contaminated ductwork. The HEPA filter housings allow for leak testing of each filter and assembly. The filters and housings are certified at least annually.
15. The BSL-3 facility design, operational parameters, and procedures are verified and documented prior to operation. Facilities are tested annually or after significant modification to ensure operational parameters are met. Verification criteria are modified as necessary by operational experience.
16. Appropriate communication systems are provided between the laboratory and the outside (e.g., voice, fax, and computer). Provisions for emergency communication and emergency access or egress are developed and implemented.

Biosafety Level 4

Biosafety Level 4 (BSL-4) is required for work with dangerous and exotic agents that pose a high individual risk of aerosol-transmitted laboratory infections and life-threatening diseases that are frequently fatal, agents for which there are no vaccines or treatments, or work with a related agent with unknown risk of transmission. Agents with a close or identical antigenic relationship to agents requiring BSL-4 containment are handled at this level until sufficient data are obtained to re-designate the level. Laboratory staff receive specific and thorough training in handling extremely hazardous infectious agents. Laboratory staff understand the primary and secondary containment functions of standard and special practices, containment equipment, and laboratory design characteristics. All laboratory staff and supervisors are competent in handling agents and procedures requiring BSL-4 containment. The laboratory supervisor controls access to the laboratory in accordance with institutional policies.

There are two models for BSL-4 laboratories:

1. Cabinet Laboratory: manipulation of agents is performed in a Class III BSC; and
2. Suit Laboratory: personnel wear a positive-pressure supplied-air protective suit.

BSL-4 cabinet and suit laboratories have special engineering and design features to prevent microorganisms from dissemination into the environment.

The following standard and special practices, safety equipment, and facility specifications are necessary for BSL-4.

A. Standard Microbiological Practices

1. The laboratory supervisor enforces the institutional policies that control safety in and access to the laboratory.
2. The laboratory supervisor ensures that laboratory personnel receive appropriate training regarding their duties, potential hazards, manipulations of infectious agents, necessary precautions to minimize exposures, and hazard/exposure evaluation procedures (e.g., physical hazards, splashes, aerosolization) and that appropriate records are maintained. Personnel receive annual updates and additional training when equipment, procedures, or policies change. All persons entering the facility are advised of the potential hazards, are instructed on the appropriate safeguards, and read and follow instructions on practices and procedures. An institutional policy regarding visitor training, occupational health requirements, and safety communication is considered.
3. Personal health status may affect an individual's susceptibility to infection and ability to receive available immunizations or prophylactic interventions. Therefore, all personnel, and particularly those of reproductive age and/or those having conditions that may predispose them to increased risk for infection (e.g., organ transplant, medical immunosuppressive agents), are provided information regarding immune competence and susceptibility to infectious agents. Individuals having such conditions are encouraged to self-identify to the institution's healthcare provider for appropriate counseling and guidance. See [Section VII](#).
4. A safety manual specific to the facility is prepared or adopted in consultation with the facility director and appropriate safety professionals. The safety manual is available, accessible, and periodically reviewed and updated as necessary.
 - a. The safety manual contains sufficient information to describe the biosafety and containment procedures for the organisms and biological materials in use, appropriate agent-specific decontamination methods, and the work performed.
 - b. The safety manual contains or references protocols for emergency situations, including exposures, medical emergencies, facility

malfunctions, and other potential emergencies. Training in emergency response procedures is provided to emergency response personnel and other responsible staff according to institutional policies.

5. A sign incorporating the universal biohazard symbol is posted at the entrance to the laboratory when infectious materials are present. Posted information includes: the laboratory's Biosafety Level, the supervisor's or other responsible personnel's name and telephone number, PPE requirements, general occupational health requirements (e.g., immunizations, respiratory protection), and required procedures for entering and exiting the laboratory. Agent information is posted in accordance with the institutional policy.
6. Long hair is restrained so that it cannot contact hands, specimen, containers, or equipment
7. Gloves are worn to protect hands from exposure to hazardous materials.
 - a. Glove selection is based on an appropriate risk assessment.
 - b. Inner gloves are not worn outside the laboratory.
 - c. Change inner gloves when contaminated, glove integrity is compromised, or when otherwise necessary.
 - d. Do not wash or reuse disposable gloves, and dispose of used gloves with other contaminated laboratory waste.
8. Gloves and other PPE are removed in a manner that minimizes personal contamination and transfer of infectious materials outside of the areas where infectious materials and/or animals are housed or manipulated.
9. Eating, drinking, smoking, handling contact lenses, applying cosmetics, and storing food for human consumption are not permitted in laboratory areas. Food is stored outside the laboratory area.
10. Mouth pipetting is prohibited. Mechanical pipetting devices are used.
11. Policies for the safe handling of sharps, such as needles, scalpels, pipettes, and broken glassware are developed, implemented, and followed; policies are consistent with applicable state, federal, and local requirements. Whenever practical, laboratory supervisors adopt improved engineering and work practice controls that reduce risk of sharps injuries. Precautions are always taken with sharp items. These include:
 - a. Plasticware is substituted for glassware whenever possible.

- b. Use of needles and syringes or other sharp instruments is limited in the laboratory and is restricted to situations where there is no alternative (e.g., parenteral injection, blood collection, or aspiration of fluids from laboratory animals or diaphragm bottles). Active or passive needle-based safety devices are to be used whenever possible.
 - i. Uncapping of needles is performed in such a manner to reduce the potential for recoil causing an accidental needlestick.
 - ii. Needles are not bent, sheared, broken, recapped, removed from disposable syringes, or otherwise manipulated by hand before disposal.
 - iii. If absolutely necessary to remove a needle from a syringe (e.g., to prevent lysing blood cells) or recap a needle (e.g., loading syringes in one room and injecting animals in another), a hands-free device or comparable safety procedure must be used (e.g., a needle remover on a sharps container, the use of forceps to hold the cap when recapping a needle).
 - iv. Used, disposable needles and syringes are carefully placed in puncture-resistant containers used for sharps disposal immediately after use. The sharps disposal container is located as close to the point of use as possible.
 - c. Non-disposable sharps are placed in a hard-walled container for transport to a processing area for decontamination, preferably by autoclaving.
 - d. Broken glassware is not handled directly. Instead, it is removed using a brush and dustpan, tongs, or forceps.
12. Perform all procedures to minimize the creation of splashes and/or aerosols.
13. Decontaminate work surfaces after completion of work and after any spill or splash of potentially infectious material with appropriate disinfectant. Spills involving infectious materials are contained, decontaminated, and cleaned up by staff who are properly trained and equipped to work with infectious material. A spill procedure is developed and posted within the laboratory.
14. Decontaminate all cultures, stocks, and other potentially infectious materials before disposal using an effective method, consistent with applicable institutional, local, and state requirements. A method for decontaminating all laboratory wastes is available in the laboratory

(e.g., autoclave, chemical disinfection, incineration, or other validated decontamination method). See B. Special Practices, #7 in the following sub-section for additional details.

15. An effective integrated pest management program is implemented. See [Appendix G](#).
16. Animals and plants not associated with the work being performed are not permitted in the laboratory.

B. Special Practices

1. All persons entering the laboratory are advised of the potential hazards and meet specific entry/exit requirements in accordance with institutional policies. Only persons whose presence in the facility or individual laboratory rooms is required for scientific or support purposes are authorized to enter. Additional training/security requirements may be required prior to gaining independent access to BSL-4 laboratories.
2. All persons who enter operational laboratory areas are provided information on signs and symptoms of disease and receive occupational medical services including medical evaluation, surveillance, and treatment, as appropriate, and offered available immunizations for agents handled or potentially present in the laboratory.
 - a. An essential adjunct to such an occupational medical services system is the availability of a facility for the isolation and medical care of personnel with potential or known Laboratory-associated infections.
3. Laboratory personnel and support staff are trained and approved to work in the facility. The laboratory supervisor is responsible for ensuring that, prior to working independently with agents requiring BSL-4 containment, laboratory personnel demonstrate high proficiency in standard and special microbiological practices and techniques for working with agents requiring BSL-4 containment. Personnel are required to read and follow instructions on practices, and procedural changes are addressed as part of the protocol review.
4. A system is established for reporting and documenting near misses, laboratory accidents, exposures, unanticipated absence due to potential Laboratory-associated infection, and for the medical surveillance of potential laboratory-associated illnesses.
5. Incidents that result in exposure to infectious materials are immediately evaluated per institutional policy. All such incidents are reported to the laboratory supervisor, institutional management, and appropriate safety,

compliance, and security personnel according to institutional policy. Appropriate records are maintained.

6. Biological materials that require BSL-4 containment are placed in a durable, leak-proof sealed primary container and then enclosed in a non-breakable, sealed secondary container prior to removal from the BSL-4 facility by authorized personnel. These materials are transferred through a disinfectant dunk tank, fumigation chamber, or decontamination shower for receipt by authorized personnel. Once removed, the primary container is not to be opened outside BSL-4 containment unless a validated inactivation method is used (e.g., gamma irradiation). See [Appendix K](#). The inactivation method is documented in-house with viability testing data to support the method.
7. All waste is decontaminated by a verified method prior to removal from the laboratory.
8. Equipment is routinely decontaminated and is decontaminated after spills, splashes, or other potential contamination and before repair, maintenance, or removal from the laboratory.
 - a. Equipment or material that might be damaged by high temperatures or steam is decontaminated using an effective and verified method, such as a gaseous or vapor method, in an airlock or chamber designed for this purpose.
9. A logbook, or other means of documenting the date and time of all persons entering and leaving the laboratory, is maintained.
10. An inventory system for agents stored within the laboratory is in place.
11. While the laboratory is operational, personnel enter and exit the laboratory through the clothing change and shower rooms except during emergencies. All personal clothing and jewelry (except eyeglasses) are removed in the outer clothing change room. All persons entering the laboratory use laboratory clothing, including undergarments, pants, shirts, socks, jumpsuits, shoes, and gloves, as appropriate. All persons leaving the laboratory take a personal body shower. Used laboratory clothing and other waste, including gloves, are not removed from the inner change room through the personal shower. These items are treated as contaminated materials and decontaminated before laundering or disposal.
12. After the laboratory has been completely decontaminated by verification of a validated method and all infectious agents are secured, necessary staff may enter and exit without following the clothing change and shower requirements described above.

13. Daily inspections of essential containment and life support systems are completed and documented before laboratory work is initiated to ensure that the laboratory is operating according to established parameters.
14. Only necessary equipment and supplies are stored inside the laboratory. All equipment and supplies taken inside the laboratory are decontaminated before removal from the laboratory.
 - a. Supplies and materials that are not brought into the laboratory through the change room are brought in through a dunk tank, previously decontaminated double-door autoclave, fumigation chamber, or airlock. After securing the outer doors, personnel within the laboratory retrieve the materials by opening the interior doors of the autoclave, fumigation chamber, or airlock. The inner door is secured after materials are brought into the facility. The outer door of the autoclave or fumigation chamber is not opened until the autoclave, fumigation chamber, or airlock has been operated through a successful decontamination cycle.

C. Safety Equipment (Primary Barriers and Personal Protective Equipment)

Cabinet Laboratory

1. All procedures involving the manipulation of infectious materials are conducted within a Class III BSC.
2. A Class III BSC contains:
 - a. Double-door, pass-through autoclave for decontaminating materials passing out of the Class III BSC(s). The autoclave doors are interlocked so that only one door can be opened at any time and are automatically controlled so that the outside door to the autoclave can only be opened after a successful decontamination cycle has been completed.
 - b. A pass-through dunk tank, fumigation chamber, or equivalent decontamination method so that materials and equipment that cannot be decontaminated in the autoclave can be safely removed from the cabinet. Containment between the cabinet and the surrounding laboratory is maintained at all times.
 - c. A HEPA filter on the supply air intake and two HEPA filters in series on the exhaust outlet of the unit. Supply air is provided in such a manner that prevents positive pressurization of the cabinet. There are gas-tight dampers on the supply and exhaust ducts of the cabinet to permit gas or vapor decontamination of the unit. Ports for injection of test medium are present on all HEPA filter housings.

- d. An interior constructed with smooth finishes that can be easily cleaned and decontaminated. All sharp edges on cabinet finishes are eliminated to reduce the potential for cuts and tears of gloves. Equipment to be placed in the Class III BSC is also free of sharp edges or other surfaces that may damage or puncture the cabinet gloves.
 - e. Gloves that are inspected for damage prior to use and changed if necessary. Gloves are replaced annually during cabinet recertification.
3. The cabinet is designed to permit maintenance and repairs of cabinet mechanical systems (e.g., refrigeration, incubators, centrifuges) to be performed from the exterior of the cabinet whenever possible.
 4. Manipulation of high concentrations or large volumes of infectious agents within the Class III BSC is performed using physical containment devices inside the cabinet whenever practical. Such materials are centrifuged inside the cabinet using sealed rotors or centrifuge safety cups.
 5. The interior of the Class III BSC and all contaminated plenums, fans, and filters are decontaminated using a validated gaseous or vapor method when there have been significant changes in cabinet usage, before major renovations or maintenance shutdowns, and in other situations, as determined by risk assessment. Success of the decontamination is verified before accessing the interior spaces of the cabinet.
 6. The Class III BSC is certified at least annually.
 7. For Class III BSCs directly connected via a double-door, pass-through to a BSL-4 suit laboratory, materials may be placed into and removed from the Class III BSC via the suit laboratory.
 8. Workers in the laboratory wear protective laboratory clothing with a solid front, such as tie-back or wrap-around gowns, scrubs, or coveralls. Shoe coverings are considered based on a risk assessment.
 - a. Upon exit, all protective clothing is removed in the inner change room before showering.
 - b. Prescription eyeglasses are decontaminated before removal through the personal body shower.
 9. Disposable gloves are worn underneath cabinet gloves to protect the worker from exposure should a break or tear occur in a cabinet glove.

Suit Laboratory

1. All procedures involving the manipulation of infectious materials are conducted within a BSC or other physical containment devices. No work with open vessels is conducted on the bench.
2. Equipment that may produce aerosols is used within primary barrier devices that exhaust air through HEPA filtration before being discharged into the laboratory or facility exhaust system. These HEPA filters are tested annually and replaced as needed.
3. Materials centrifuged in the laboratory use sealed rotors or centrifuge safety cups. Loading and unloading of the rotors and centrifuge safety cups take place in the BSC or another containment device.
4. All procedures are conducted by personnel wearing a one-piece, positive-pressure supplied-air suit.
 - a. All persons don laboratory clothing, such as scrubs, before entering the room used for donning positive-pressure suits.
 - b. Procedures are in place to control and verify the operation of the one-piece positive-pressure supplied-air suit, including gloves, before each use.
 - c. Decontamination of outer suit gloves is performed during the course of normal laboratory operations to remove gross contamination and minimize further contamination of the laboratory.
 - d. Inner disposable gloves are worn to protect the laboratorian should a break or tear in the outer suit gloves occur. Disposable inner gloves are not worn outside the inner change area.
 - e. Upon exit from the chemical shower, inner gloves and all laboratory clothing are removed and discarded or collected for autoclaving before laundering prior to entering the personal shower.
 - f. Prescription eyeglasses are decontaminated before removal through the personal body shower.

D. Laboratory Facilities (Secondary Barriers)

Cabinet Laboratory

1. The BSL-4 cabinet facility may be located in a separate building or a clearly demarcated and isolated zone within a building.
 - a. Facility access is restricted. Laboratory doors are lockable.

- b. Exit from the laboratory is by sequential passage through an inner (i.e., dirty) changing area, a personal shower, and an outer (i.e., clean) change room upon exiting the cabinet laboratory.
2. An automatically activated emergency power source is provided, at a minimum, for the laboratory exhaust system, alarms, lighting, entry and exit controls, BSCs, and door gaskets.
 - a. Monitoring and control systems for air supply, exhaust, life support, alarms, entry and exit controls, and security systems are on an uninterrupted power supply (UPS).
3. A double-door autoclave, dunk tank, fumigation chamber, or ventilated airlock is provided at the containment barrier for the passage of materials, supplies, or equipment.
4. A hands-free sink is provided near the door of the cabinet laboratory(ies) and the inner change room. A sink is provided in the outer change room.
5. An eyewash station is readily available in the laboratory.
6. Walls, floors, and ceilings of the cabinet laboratory are constructed to form a sealed internal shell to facilitate fumigation and prohibit animal and insect intrusion. The internal surfaces of this shell are resistant to liquids and chemicals used for cleaning and decontamination of the area. Floors are monolithic, sealed, and coved.
 - a. All penetrations in the internal shell of the cabinet laboratory and inner change room are sealed.
 - b. Openings around doors into the cabinet laboratory and inner change room are minimized and capable of being sealed to facilitate decontamination.
7. Services and plumbing that penetrate the cabinet laboratory walls, floors, or ceiling are installed to ensure that no backflow from the laboratory occurs. These penetrations are fitted with two (in series) backflow prevention devices. Consideration is given to locating these devices outside of containment. Atmospheric venting systems are provided with two HEPA filters in series and are sealed up to the second filter.
8. Furniture is minimized, of simple construction, and capable of supporting anticipated loads and uses.
 - a. Spaces between benches, cabinets, and equipment are accessible for cleaning and decontamination.
 - b. Benchtops are impervious to water and resistant to heat, organic solvents, acids, alkalis, and other chemicals.

- c. Chairs used in laboratory work are covered with a non-porous material that can be easily cleaned and decontaminated.
- 9. Windows are break-resistant and sealed.
- 10. Illumination is adequate for all activities and avoids reflections and glare that could impede vision.
- 11. If Class II BSCs or other primary containment barrier systems are needed in the cabinet laboratory, they are installed and operated in a manner to ensure their effectiveness. See [Appendix A](#).
 - a. BSCs are installed so that fluctuations of the room air supply and exhaust do not interfere with proper operations. BSCs are located away from doors, heavily traveled laboratory areas, and other possible airflow disruptions.
 - b. BSCs can be connected to the laboratory exhaust system by either a canopy connection (Class IIA only) or directly exhausted to the outside through a hard connection (Class IIB, IIC, or III). Cabinet exhaust air passes through two HEPA filters, including the HEPA in the BSC, prior to release outside. Class IIA or IIC BSC exhaust can be safely recirculated back into the laboratory environment if no volatile toxic chemicals are used in the cabinet.
 - c. BSCs are certified at least annually to ensure correct performance, or as specified in [Appendix A, Part 7](#).
- 12. Central vacuum systems are discouraged. If there is a central vacuum system, it does not serve areas outside the cabinet. Two in-line HEPA filters are placed near each use point and overflow collection is provided while in use. Filters are installed to permit in-place decontamination and replacement.
- 13. A dedicated, non-recirculating ventilation system is provided. Only cabinet laboratories with the same HVAC requirements (i.e., other BSL-4 cabinet laboratories, ABSL-4 cabinet facilities) may share ventilation systems if gas-tight dampers and HEPA filters isolate each individual laboratory system.
 - a. The supply and exhaust components of the ventilation system are designed to maintain the laboratory at negative pressure to surrounding areas and provide differential pressure or directional airflow, as appropriate, between adjacent areas within the laboratory.
 - b. Redundant supply fans are recommended. Redundant exhaust fans are required. Supply and exhaust fans are interlocked to prevent positive pressurization of the cabinet laboratory.

- c. The ventilation system is monitored and alarmed to indicate malfunction or deviation from design parameters. A visual monitoring device is installed outside of containment so proper differential pressures within the laboratory may be verified prior to entry and during regular checklist procedures. Visual monitoring is also in place within containment.
 - d. Supply air to and exhaust air from the cabinet laboratory, inner change room, and fumigation/decontamination chambers pass through a HEPA filter. The air exhaust discharge is located away from occupied spaces and building air intakes.
 - e. All HEPA filters are located as near as practicable to the cabinet and laboratory to minimize the length of potentially contaminated ductwork. All HEPA filters are tested and certified annually.
 - f. The HEPA filter housings are designed to allow for in situ decontamination and verification of the validated decontamination process prior to removal. The design of the HEPA filter housing has gas-tight isolation dampers, decontamination ports, and the ability to individually scan each filter in the assembly for leaks.
14. Pass-through dunk tanks, fumigation chambers, or equivalent decontamination methods are provided so that materials and equipment that cannot be decontaminated in the autoclave can be safely removed from the cabinet laboratory(ies). Access to the exit side of the pass-through is limited to those with authorized access to the BSL-4 laboratory and with specific clearance, if required.
15. Liquid effluents from cabinet laboratory sinks, floor drains, autoclave chambers, and other sources within the cabinet laboratory are decontaminated by a proven method, preferably heat treatment, before being discharged to the sanitary sewer.
- a. Decontamination of all liquid effluents is documented. The decontamination process for liquid effluents is validated physically and biologically. Biological validation is performed at least annually or more often, if required by institutional policy.
 - b. Effluents from personal body showers and toilets may be discharged to the sanitary sewer without treatment.
16. A double-door, pass-through autoclave is provided for decontaminating materials passing out of the cabinet laboratory. Autoclaves that open outside of the laboratory are sealed to the wall through which the autoclave passes. This bioseal is durable, airtight, and capable of expansion and contraction. Positioning the bioseal so that the equipment

can be accessed and maintained from outside the laboratory is strongly recommended. The autoclave doors are interlocked so that only one can be opened at any time and are automatically controlled so that the outside door to the autoclave can only be opened after the decontamination cycle has been completed.

- a. Gas discharge from the autoclave chamber is HEPA-filtered or decontaminated. Autoclave decontamination processes are designed so that unfiltered air or steam exposed to infectious material cannot be released to the environment.
17. The facility design parameters and operational procedures are documented. The facility is tested to verify that the design and operational parameters have been met prior to operation. Facilities are also re-tested annually or after significant modification to ensure operational parameters are met. Verification criteria are modified, as necessary, by operational experience.
 18. Appropriate communication systems are provided between the laboratory and the outside (e.g., voice, fax, video, and computer). Provisions for emergency communication and emergency access or egress are developed and implemented.

Suit Laboratory

1. The BSL-4 suit facility may be located in a separate building or a clearly demarcated and isolated zone within a building.
 - a. Facility access is restricted. Laboratory doors are lockable.
 - b. Entry into the laboratory is through an airlock fitted with airtight doors.
 - c. Exit from the laboratory is by sequential passage through the chemical shower, inner (i.e., dirty) change room, personal shower, and outer (i.e., clean) changing area.
2. Personnel who enter this area wear a positive-pressure suit supplied with HEPA-filtered breathing air. The breathing air systems have redundant compressors, failure alarms, and emergency back-up capable of supporting all workers within the laboratory to allow the personnel to safely exit the laboratory.
3. A chemical shower is provided to decontaminate the surface of the positive-pressure suit before the worker leaves the laboratory. In the event of an emergency exit or failure of the chemical shower system, a method for decontaminating positive-pressure suits, such as a gravity-fed supply of chemical disinfectant, is provided.

4. An automatically activated emergency power source is provided at a minimum for the laboratory exhaust system, alarms, lighting, entry and exit controls, BSCs, and door gaskets.
 - a. Monitoring and control systems for air supply, exhaust, life support, alarms, entry and exit controls, and security systems are on an uninterrupted power supply (UPS).
5. A double-door autoclave, dunk tank, or fumigation chamber is provided at the containment barrier for the passage of materials, supplies, or equipment in or out of the laboratory.
6. Hands-free sinks inside the suit laboratory are placed near procedure areas.
7. An eyewash station for use during maintenance is readily available in the laboratory area.
8. Walls, floors, and ceilings of the laboratory are constructed to form a sealed internal shell to facilitate fumigation and prohibit animal and insect intrusion. The internal surfaces of this shell are resistant to liquids and chemicals used for cleaning and decontamination of the area. Floors are monolithic, sealed, and coved.
 - a. All penetrations in the internal shell of the laboratory, suit storage room, and the inner change room are sealed.
9. Services and plumbing that penetrate the laboratory walls, floors, or ceiling are installed to ensure that no backflow from the laboratory occurs. Breathing air systems are exempt from this provision. These penetrations are fitted with two (in series) backflow prevention devices. Consideration is given to locating these devices outside of containment. Atmospheric venting systems are provided with two HEPA filters in series and are sealed up to the second filter.
10. Decontamination of the entire laboratory is performed using a validated gaseous or vapor method when there have been significant changes in usage, before major renovations or maintenance shutdowns, and in other situations, as determined by risk assessment. Decontamination is verified prior to any change in the status of the laboratory.
11. Furniture is minimized, of simple construction, and capable of supporting anticipated loads and uses.
 - a. Spaces between benches, cabinets, and equipment are accessible for cleaning, decontamination, and unencumbered movement of personnel.

- b. Benchtops are impervious to water and resistant to heat, organic solvents, acids, alkalis, and other chemicals.
 - c. Chairs used in laboratory work are covered with a non-porous material that can be easily cleaned and decontaminated.
 - d. Sharp edges and corners are avoided.
12. Windows are break-resistant and sealed.
13. Illumination is adequate for all activities and avoids reflections and glare that could impede vision.
14. BSCs and other primary containment barrier systems are installed and operated in a manner to ensure their effectiveness. See [Appendix A](#).
- a. BSCs are installed so that fluctuations of the room air supply and exhaust do not interfere with proper operations. BSCs are located away from doors, windows that can be opened, heavily traveled laboratory areas, and other possible airflow disruptions.
 - b. BSCs can be connected to the laboratory exhaust system by either a canopy connection (Class IIA only) or directly exhausted to the outside through a hard connection (Class IIB, IIC, or III), which contains a HEPA filter.
 - c. Class IIA or IIC BSC exhaust can be safely recirculated back into the laboratory environment if no volatile toxic chemicals are used in the cabinet.
 - d. BSCs are certified at least annually to ensure correct performance, or as specified in [Appendix A, Part 7](#).
 - e. Class III BSCs are provided supply air in such a manner that prevents positive pressurization of the cabinet or the room.
15. Central vacuum systems are discouraged. If there is a central vacuum system, it does not serve areas outside the laboratory. Two in-line HEPA filters are placed near each use point and overflow collection is provided while in use. Filters are installed to permit in-place decontamination and replacement. Consideration is made to the provision of two HEPA filters in series as close to the vacuum pump as possible.
16. A dedicated, non-recirculating ventilation system is provided. Only laboratories or facilities with the same HVAC requirements (i.e., other BSL-4 laboratories, ABSL-4, ABSL-3Ag, ABSL-4Ag facilities) may share ventilation systems if gas-tight dampers and HEPA filters isolate each individual laboratory system.

- a. The ventilation system is designed to maintain the laboratory at negative pressure to surrounding areas and provide differential pressure or directional airflow as appropriate between adjacent areas within the laboratory.
 - b. Redundant supply fans are recommended. Redundant exhaust fans are required. Supply and exhaust fans are interlocked to prevent positive pressurization of the laboratory.
 - c. The ventilation system is monitored and alarmed to indicate malfunction or deviation from design parameters. A visual monitoring device is installed outside of containment so proper differential pressures within the laboratory may be verified prior to entry and during regular checklist procedures. Visual monitoring is also in place within containment.
 - d. Supply air to the laboratory, including the decontamination shower, passes through a HEPA filter. All exhaust air from the suit laboratory, decontamination shower, and fumigation or decontamination chambers passes through two HEPA filters, in series, before discharge to the outside. The exhaust air discharge is located away from occupied spaces and air intakes.
 - e. All HEPA filters are located as near as practicable to the laboratory to minimize the length of potentially contaminated ductwork. All HEPA filters are tested and certified annually.
 - f. The HEPA filter housings are designed to allow for in situ decontamination of the filter and verification of the validated process prior to removal. The design of the HEPA filter housing has gas-tight isolation dampers, decontamination ports, and the ability to individually scan each filter in the assembly for leaks.
17. Pass-through dunk tanks, fumigation chambers, or equivalent decontamination methods are provided so that materials and equipment that cannot be decontaminated in the autoclave can be safely removed from the laboratory. Access to the exit side of the pass-through is limited to those individuals authorized to be in the facility and provided appropriate clearance if required.
18. Liquid effluents from chemical showers, sinks, floor drains, autoclave chambers, and other sources within the laboratory are decontaminated by a proven method, preferably heat treatment, before being discharged to the sanitary sewer.
- a. Decontamination of all liquid effluents is documented. The decontamination process for liquid effluents is validated physically and

- biologically. Biological validation is performed at least annually or more often if required by institutional policy.
- b. Effluents from personal body showers and toilets may be discharged to the sanitary sewer without treatment.
19. A double-door, pass-through autoclave(s) is provided for decontaminating materials passing out of the laboratory. Autoclaves that open outside of the laboratory are sealed to the wall through which the autoclave passes. This bioseal is durable, airtight, and capable of expansion and contraction. Positioning the bioseal so that the equipment can be accessed and maintained from outside the laboratory is strongly recommended. The autoclave doors are interlocked so that only one can be opened at any time and be automatically controlled so that the outside door to the autoclave can only be opened after a successful decontamination cycle has been completed.
 - a. Gas discharge from the autoclave chamber is HEPA-filtered or is decontaminated. Autoclave decontamination processes are designed so that unfiltered air or steam exposed to infectious material cannot be released to the environment.
 20. The facility design parameters and operational procedures are documented. The facility is tested to verify that the design and operational parameters have been met prior to operation. Facilities are also re-tested annually or after significant modification to ensure operational parameters are maintained. Verification criteria are modified, as necessary, by operational experience.
 21. Appropriate communication systems are provided between the laboratory and the outside (e.g., voice, fax, video, and computer). Provisions for emergency communication and emergency access or egress are developed and implemented.

Table 1. Summary of Laboratory Biosafety Levels (BSLs)

BSL	Agents	Special Practices^a	Primary Barrier and Personal Protective Equipment^a	Facilities (Secondary Barriers)^a
1	Well-characterized agents not known to consistently cause disease in immunocompetent adult humans and present minimal potential hazard to laboratory personnel and the environment.	Standard microbiological practices	No primary barriers required; protective laboratory clothing; protective face, eyewear, as needed	Laboratory doors; sink for handwashing; laboratory bench; windows fitted with screens; lighting adequate for all activities
2	Agents associated with human disease and pose moderate hazards to personnel and the environment	Limited access; occupational medical services including medical evaluation, surveillance, and treatment, as appropriate; all procedures that may generate an aerosol or splash conducted in a BSC; decontamination process needed for laboratory equipment	BSCs or other primary containment device used for manipulations of agents that may cause splashes or aerosols; protective laboratory clothing; other PPE, including respiratory protection, as needed	Self-closing doors; sink located near exit; windows sealed or fitted with screens; autoclave available
3	Indigenous or exotic agents; may cause serious or potentially lethal disease through the inhalation route of exposure	Access limited to those with need to enter; viable material removed from laboratory in primary and secondary containers; opened only in BSL-3 or ABSL-3 laboratories; all procedures with infectious materials performed in a BSC	BSCs for all procedures with viable agents; solid front gowns, scrubs, or coveralls; two pairs of gloves, when appropriate; protective eyewear, respiratory protection, as needed	Physical separation from access corridors; access through two consecutive self-closing doors; hands-free sink near exit; windows are sealed; ducted air ventilation system with negative airflow into laboratory; autoclave available, preferably in laboratory

Continued on next page ►

BSL	Agents	Special Practices^a	Primary Barrier and Personal Protective Equipment^a	Facilities (Secondary Barriers)^a
4	Dangerous and exotic agents that pose high individual risk of aerosol-transmitted laboratory infections and life-threatening disease that are frequently fatal, for which there are no vaccines or treatments; and related agents with unknown risk of transmission	Clothing change before entry; daily inspections of essential containment and life support systems; all wastes decontaminated prior to removal from laboratory; shower on exit	BSCs for all procedures with viable agents; solid front gowns, scrubs, or coveralls; ^b gloves; ^b full-body, air-supplied, positive-pressure suit ^c	Entry sequence; entry through airlock with airtight doors; ^c walls, floors, ceilings form sealed internal shell; dedicated, non-recirculating ventilation system required; double-door, pass-through autoclave required

- a. Each successive BSL contains the recommendations of the preceding level(s) and the criteria in the cell.
- b. Applies to Cabinet Laboratory
- c. Applies to Suit Laboratory

Section V—Vertebrate Animal Biosafety Level Criteria for Vivarium Research Facilities

This guidance is provided for the use of experimentally infected animals housed in indoor research facilities (e.g., vivarium research facilities) and applies to the maintenance of laboratory animals that may naturally harbor zoonotic infectious agents. In both instances, institutional management provides facilities, staff, and established practices that reasonably ensure appropriate levels of environmental quality, safety, security, and care for the laboratory animal.¹ Laboratory animal facilities are to be considered a special type of laboratory. As a general principle, the Biosafety Level (e.g., facilities, practices, and operational requirements) recommended for working with infectious agents *in vivo* and *in vitro* are comparable.

The animal room can present unique concerns. Animals may generate aerosols, may bite and scratch, and/or may be infected with a zoonotic agent. The application of the Animal Biosafety Levels (ABSL) is determined by a protocol-driven risk assessment.

These recommendations presuppose that laboratory animal facilities, operational practices, and quality of animal care are approved by an Institutional Animal Care and Use Committee (IACUC)² and meet applicable standards and regulations (e.g., *Guide for the Care and Use of Laboratory Animals*,³ Animal Welfare Regulations).^{4,5} In addition, the organization has an occupational health and safety program that addresses potential hazards associated with the conduct of laboratory animal research. *Occupational Health and Safety in the Care and Use of Research Animals*,⁶ published by the Institute for Laboratory Animal Research (ILAR), is most helpful in this regard. Additional safety guidance on working with non-human primates (NHPs) is available in the ILAR publication, *Occupational Health and Safety in the Care and Use of Nonhuman Primates*.⁷

Personnel receive specific training in humane animal care and handling in accordance with the appropriate regulatory requirements and guidance documents (e.g., Animal Welfare Regulations,⁴ *Guide for the Care and Use of Laboratory Animals*,³ and taxon-specific publications for wild/exotic animals) as well as animal facility procedures, and are supervised by an individual with adequate knowledge of potential hazards and experimental animal procedures. This includes training on proper use of engineering controls, including biosafety cabinets (BSCs) or downdraft tables, as well as personal protective equipment (PPE) appropriate to the ABSL as determined by a risk assessment. The biosafety officer (BSO), the IBC, or equivalent resource, and/or other applicable committees are responsible for the review of protocols and policies to protect personnel who manipulate and care for animals from hazardous exposures.

Facilities for laboratory animals used in studies of infectious or non-infectious disease should be physically separate from other activities, such as animal production, quarantine, clinical laboratories, and from facilities providing patient care. Traffic flow that will minimize the risk of cross-contamination should be incorporated into the facility.

The recommendations detailed below describe four combinations of practices, safety equipment, and facilities for experiments with animals involved in infectious disease research and other studies that may require containment. These four combinations, designated ABSL-1–4, provide increasing levels of protection to personnel and to the environment, and are recommended as minimum standards for activities involving infected laboratory animals. The four ABSLs describe animal facilities and practices applicable to work with animals infected with agents requiring BSL-1–4 containment, respectively. Investigators who are inexperienced should seek help in designing their experiments from individuals experienced in this specialized work.

In addition to the ABSLs described in this section, the USDA has developed facility parameters and work practices for handling agents of agricultural significance. [Appendix D](#) includes a discussion on Animal Biosafety Levels 2, 3, and 4 Agriculture (ABSL-2Ag, ABSL-3Ag, ABSL-4Ag). The “Ag” designation is used for animals that are loose-housed or in open penning and may be exposed to agents of concern from an agricultural perspective. USDA requirements are unique to agriculture because of the necessity to protect the environment from pathogens of economic or environmental impact. [Appendix D](#) also describes some of the enhancements beyond standard recommendation at ABSL-2–4 that may be required by USDA APHIS when working in the laboratory or vivarium with certain veterinary agents of concern.

Facility standards and practices for invertebrate vectors and hosts are not specifically addressed in this section. Please refer to [Appendix E](#) for additional information on the Arthropod Containment Guidelines (ACG).

Animal Biosafety Level 1

Animal Biosafety Level 1 (ABSL-1) is suitable for animal work involving well-characterized agents that are not known to consistently cause disease in immunocompetent adult humans and present minimal potential hazard to personnel and the environment.

Special containment equipment or facility design may be required as determined by risk assessment. See [Section II](#) for additional information on the Biological Risk Assessment.

Personnel receive specific training in animal facility procedures and are supervised by an individual with adequate knowledge of potential hazards and experimental animal procedures.

The following standard practices, safety equipment, and facility specifications are recommended for ABSL-1.

A. Standard Microbiological Practices

1. The animal facility director establishes and enforces policies, procedures, and protocols for biosafety, biosecurity, and emergencies within the animal facility.
2. Access to the animal room is limited. Only those persons required for experimental, husbandry, or support purposes are authorized to enter the facility.
3. Each institution ensures that worker safety and health concerns are addressed as part of the animal protocol review process. Consideration is given to specific biohazards unique to the animal species and protocol in use. Prior to beginning a study, animal protocols are reviewed and approved by the Institutional Animal Care and Use Committee (IACUC) as well as the Institutional Biosafety Committee (IBC), as appropriate.
4. The supervisor ensures that animal care, facility, and support personnel receive appropriate training regarding their duties, animal husbandry procedures, potential hazards, manipulations of infectious agents, necessary precautions to minimize exposures, and hazard/exposure evaluation procedures (e.g., physical hazards, splashes, aerosolization). Personnel receive annual updates and additional training when equipment, procedures, or policies change. Records are maintained for all hazard evaluations, training sessions, and staff attendance. All persons, including facility equipment personnel, service workers, and visitors, are advised of the potential hazards (e.g., naturally acquired or research pathogens, allergens); are instructed on the appropriate safeguards; and read and follow instructions on practices and procedures. An institutional policy regarding visitor training, occupational health requirements, and safety communication is considered.
5. Personal health status may affect an individual's susceptibility to infection or ability to receive available immunizations or prophylactic interventions. Therefore, all personnel, and particularly those of reproductive age and/or those having conditions that may predispose them to increased risk for infection (e.g., organ transplant, medical immunosuppressive agents), are provided information regarding immune

competence and susceptibility to infectious agents. Individuals having such conditions are encouraged to self-identify to the institution's healthcare provider for appropriate counseling and guidance. See [Section VII](#). Facility supervisors ensure that medical staff are informed of potential occupational hazards within the animal facility, to include those associated with research, animal husbandry duties, animal care, and manipulations.

6. Appropriate occupational medical services are in place, as determined by risk assessment.
 - a. An animal allergy prevention program is part of the medical surveillance.
 - b. Personnel using respirators for animal allergy prevention are enrolled in an appropriately constituted respiratory protection program.
7. A safety manual specific to the facility is prepared or adopted in consultation with the facility director and appropriate safety professionals. The safety manual is available, accessible, and periodically reviewed and updated, as necessary.
 - a. The safety manual contains sufficient information to describe the biosafety and containment procedures for the experimental animals, organisms, and biological materials in use, appropriate agent-specific decontamination methods, and the work performed.
 - b. The safety manual contains or references protocols for emergency situations, including exposures, medical emergencies, facility malfunctions, escape of animals within the animal facility, and other potential emergencies. A plan for the disposition of animals during emergency situations is included. Training in emergency response procedures is provided to emergency response personnel and other responsible staff according to institutional policies.
8. A sign is posted at the entrance to the animal room when infectious agents are present. Posted information includes: the room's Animal Biosafety Level, the supervisor's or other responsible personnel's name and telephone number, PPE requirements, general occupational health requirements (e.g., immunizations, respiratory protection), and required procedures for entering and exiting the animal room. Agent information is posted in accordance with the institutional policy.
9. Long hair is restrained so that it cannot contact hands, animals, specimens, containers, or equipment.

10. Gloves are worn to protect hands from exposure to hazardous materials and when handling animals.
 - a. Glove selection is based on an appropriate risk assessment.⁸⁻¹²
 - b. Consider the need for bite and/or scratch-resistant gloves.
 - c. Gloves worn inside the animal facility are not worn outside the animal facility.
 - d. Change gloves when contaminated, glove integrity is compromised, or when otherwise necessary.
 - e. Do not wash or reuse disposable gloves, and dispose of used gloves with other contaminated animal facility waste.
11. Gloves and other PPE are removed in a manner that minimizes personal contamination and transfer of infectious materials outside of the areas where infectious materials and/or animals are housed or manipulated.
12. Persons wash their hands after handling animals and before leaving the areas where infectious materials and/or animals are housed or manipulated.
13. Eating, drinking, smoking, handling contact lenses, applying cosmetics, and storing food for human consumption are not permitted in animal areas.
14. Mouth pipetting is prohibited. Mechanical pipetting devices are used.
15. Policies for the safe handling of sharps, such as needles, scalpels, pipettes, and broken glassware are developed, implemented, and followed; policies are consistent with applicable state, federal, and local requirements.¹³ Whenever practical, supervisors adopt improved engineering and work practice controls that reduce the risk of sharps injuries. Precautions are always taken with sharp items. These include:
 - a. Plasticware is substituted for glassware whenever possible.
 - b. Use of needles and syringes or other sharp instruments is limited in the animal facility and is restricted to situations where there is no alternative (e.g., parenteral injection, blood collection, or aspiration of fluids from laboratory animals or diaphragm bottles). Active or passive needle-based safety devices are used whenever possible.
 - i. Uncapping of needles is performed in such a manner to reduce the potential for recoil causing an accidental needlestick.
 - ii. Needles are not bent, sheared, broken, recapped, removed from disposable syringes, or otherwise manipulated by hand before disposal.

- iii. If absolutely necessary to remove a needle from a syringe (e.g., to prevent lysing blood cells) or recap a needle (e.g., loading syringes in one room and injecting animals in another), a hands-free device or comparable safety procedure must be used (e.g., a needle remover on a sharps container, or the use of forceps to hold the cap when recapping a needle).
 - iv. Used, disposable needles and syringes are carefully placed in puncture-resistant containers used for sharps disposal immediately after use. The sharps disposal container is located as close to the point of use as possible.
- c. Non-disposable sharps (e.g., necropsy instruments such as forceps, pins, reusable scalpels) are placed in a hard-walled container for transport to a processing area for decontamination.
 - d. Broken glassware is not handled directly. Instead, it is removed using a brush and dustpan, tongs, or forceps.
16. All procedures are carefully performed to minimize the creation of aerosols or splatters of infectious materials and waste.
17. Decontaminate work surfaces after completion of work and after any spill or splash of potentially infectious material with appropriate disinfectant. Spills involving infectious materials are contained, decontaminated, and cleaned up by staff who are properly trained and equipped to work with infectious material. A spill procedure is developed and posted within the animal facility.
18. Decontaminate all cultures, stocks, and other potentially infectious materials before disposal using an effective method, consistent with applicable institutional, local and state requirements. Depending on where the decontamination will be performed, the following methods are used prior to transport:
- a. Materials to be decontaminated outside of the immediate animal room are placed in a durable, leak-proof container and secured for transport. For infectious materials, the outer surface of the container is disinfected prior to moving materials and the transport container has a universal biohazard label.
 - b. Materials to be removed from the facility for decontamination are packed in accordance with applicable local, state, and federal regulations.
19. An effective integrated pest management program is required. See [Appendix G](#).

20. Animals and plants not associated with the work being performed are not permitted in the areas where infectious materials and/or animals are housed or manipulated.

B. Special Practices

None required.

C. Safety Equipment (Primary Barriers and Personal Protective Equipment)

1. Specialized devices or equipment for restraint or containment may be required as determined by appropriate risk assessment.
2. Laboratory coats, gowns, or uniforms are the minimum recommended to prevent contamination of personal clothing. Protective outer clothing is not worn outside areas where infectious materials and/or animals are housed or manipulated. Gowns and uniforms are not worn outside the animal facility.
3. Eye protection and face protection (e.g., safety glasses, goggles, mask, face shield, or other splatter guard) are used for manipulations or activities that may result in splashes or sprays of infectious or other hazardous materials. Eye protection and face protection are disposed of with other contaminated facility waste or decontaminated after use.
4. Persons having contact with NHPs assess the risk of mucous membrane exposure and wear protective equipment (e.g., face shield, surgical mask, goggles), as appropriate.
5. Additional PPE is considered for persons working with large animals.

D. Animal Facilities (Secondary Barriers)

1. ABSL-1 facilities should be separated from the general traffic patterns of the building and restricted as appropriate. Consider placing animal areas away from exterior walls of buildings to minimize the impact from the outside environment temperatures.
 - a. External facility doors are self-closing and self-locking.
 - b. Access to the animal facility is restricted.
 - c. Doors to areas where infectious materials and/or animals are housed open inward, are self-closing, are kept closed when experimental animals are present, and never propped open. Doors to cubicles inside an animal room may open outward or slide horizontally or vertically.

2. The animal facility has a sink for handwashing.
 - a. Emergency eyewash and shower are readily available, easily accessible, and appropriately maintained.
 - b. Sink traps are filled with water and/or appropriate disinfectant to prevent the migration of vermin and gases.
 - c. If open floor drains are provided, the traps are filled with water and/or appropriate disinfectant or sealed to prevent the migration of vermin and gases.
3. The animal facility is designed, constructed, and maintained to facilitate cleaning and housekeeping. The interior surfaces (e.g., walls, floors, ceilings) are water-resistant.
 - a. Floors are slip-resistant, impervious to liquids, and resistant to chemicals. Floors with drains are sloped toward drains to facilitate cleaning.
 - b. It is recommended that penetrations in floors, walls, and ceilings be sealed, including openings around ducts, doors, doorframes, outlets, and switch plates to facilitate pest control and proper cleaning.
 - c. Internal facility fixtures, such as light fixtures, air ducts, and utility pipes, are designed and installed to minimize horizontal surface areas to facilitate cleaning and minimize the accumulation of debris or fomites.
 - d. External windows are not recommended; if present, they are resistant to breakage. Where possible, windows are sealed. If the animal facility has windows that open, they are fitted with fly screens.
 - e. Illumination is adequate for all activities and avoids reflections and glare that could impede vision.
4. Furniture can support anticipated loads and uses.
 - a. Benchtops are impervious to water and resistant to heat, organic solvents, acids, alkalis, and other chemicals.
 - b. Chairs used in animal areas are covered with a non-porous material that can be easily cleaned and decontaminated with an appropriate disinfectant and sealed to prevent harboring of insects/vermin.
 - c. Equipment and furnishings are carefully evaluated to minimize exposure of personnel to pinch points and sharp edges and corners.

5. Ventilation is provided in accordance with the *Guide for the Care and Use of Laboratory Animals*.³
 - a. Ventilation system design considers the heat and high moisture load produced during the cleaning of animal rooms and the cage wash process.
6. Cages are washed manually or preferably in a mechanical cage washer. The mechanical cage washers have a final rinse temperature of at least 180°F. If manual cage washing is utilized, ensure that appropriate disinfectants are selected.

Animal Biosafety Level 2

Animal Biosafety Level 2 (ABSL-2) builds upon the practices, procedures, containment equipment, and facility requirements of ABSL-1. ABSL-2 is suitable for work involving laboratory animals infected with agents associated with human disease and posing a moderate hazard to personnel and the environment. It also addresses hazards from ingestion and from percutaneous and mucous membrane exposure.

ABSL-2 requires that, in addition to the requirements for ABSL-1, a BSC or other physical containment equipment is used when procedures involve the manipulation of infectious materials or where aerosols or splashes may be created.

Appropriate PPE is worn to reduce exposure to infectious agents, animals, and contaminated equipment. An appropriate occupational health program is in place, as determined by risk assessment.

The following standard and special practices, safety equipment, and facility specifications are recommended for ABSL-2.

A. Standard Microbiological Practices

1. The animal facility director establishes and enforces policies, procedures, and protocols for biosafety, biosecurity, and emergencies within the animal facility.
2. Access to the animal room is limited. Only those persons required for experimental, husbandry, or support purposes are authorized to enter the facility.
3. Each institution ensures that worker safety and health concerns are addressed as part of the animal protocol review process. Consideration is given to specific biohazards unique to the animal species and protocol in use. Prior to beginning a study, animal protocols are also reviewed and approved by the Institutional Animal Care and Use Committee

(IACUC) and the Institutional Biosafety Committee (IBC), or equivalent resource, as appropriate.

4. The supervisor ensures that animal care, facility, and support personnel receive appropriate training regarding their duties, animal husbandry procedures, potential hazards, manipulations of infectious agents, necessary precautions to minimize exposures, and hazard/exposure evaluation procedures (e.g., physical hazards, splashes, aerosolization). Personnel receive annual updates and additional training when equipment, procedures, or policies change. Records are maintained for all hazard evaluations, training sessions, and staff attendance. All persons, including facility equipment personnel, service workers, and visitors, are advised of the potential hazards (e.g., naturally acquired or research pathogens, allergens); are instructed on the appropriate safeguards; and read and follow instructions on practices and procedures. An institutional policy regarding visitor training, occupational health requirements, and safety communication is considered.
5. Personal health status may affect an individual's susceptibility to infection and ability to receive available immunizations or prophylactic interventions. Therefore, all personnel, and particularly those of reproductive age and/or those having conditions that may predispose them to increased risk for infection (e.g., organ transplant, medical immunosuppressive agents), are provided information regarding immune competence and susceptibility to infectious agents. Individuals having such conditions are encouraged to self-identify to the institution's healthcare provider for appropriate counseling and guidance. See [Section VII](#). Facility supervisors ensure that medical staff are informed of potential occupational hazards within the animal facility, to include those associated with research, animal husbandry duties, animal care, and manipulations.
6. Appropriate occupational medical services are in place, as determined by risk assessment.
 - a. An animal allergy prevention program is part of the medical surveillance.
 - b. Personnel using respirators for animal allergy prevention are enrolled in an appropriately constituted respiratory protection program.
7. A safety manual specific to the facility is prepared or adopted in consultation with the facility director and appropriate safety professionals. The safety manual is available, accessible, and periodically reviewed and updated as necessary.

- a. The safety manual contains sufficient information to describe the biosafety and containment procedures for the experimental animals, organisms, biological materials in use, and the work performed.
 - b. The safety manual contains or references protocols for emergency situations, including exposures, medical emergencies, facility malfunctions, escape of animals within the animal facility, and other potential emergencies. A plan for the disposition of animals during emergency situations is included. Training in emergency response procedures is provided to emergency response personnel and other responsible staff according to institutional policies.
8. A sign is posted at the entrance to the animal room when infectious agents are present. Posted information includes: the universal biohazard symbol, the room's Animal Biosafety Level, the supervisor's or other responsible personnel's name and telephone number, PPE requirements, general occupational health requirements (e.g., immunization, respiratory protection), and required procedures for entering and exiting the animal room. Agent information is posted in accordance with the institutional policy.
 9. Long hair is restrained so that it cannot contact hands, animals, specimens, containers, or equipment.
 10. Gloves are worn to protect hands from exposure to hazardous materials and when handling animals.
 - a. Glove selection is based on an appropriate risk assessment.
 - b. Consider the need for bite and/or scratch-resistant gloves.
 - c. Gloves worn inside the animal facility are not worn outside the animal facility.
 - d. Change gloves when contaminated, glove integrity is compromised, or when otherwise necessary.
 - e. Do not wash or reuse disposable gloves, and dispose of used gloves with other contaminated animal facility waste.
 11. Gloves and other PPE are removed in a manner that minimizes personal contamination and transfer of infectious materials outside of the areas where infectious materials and/or animals are housed or manipulated.
 12. Persons wash their hands after handling animals and before leaving the areas where infectious materials and/or animals are housed or manipulated.

13. Eating, drinking, smoking, handling contact lenses, applying cosmetics, and storing food for human consumption are not permitted in animal areas.
14. Mouth pipetting is prohibited. Mechanical pipetting devices are used.
15. Policies for the safe handling of sharps, such as needles, scalpels, pipettes, and broken glassware are developed, implemented, and followed; policies are consistent with applicable state, federal, and local requirements. Whenever practical, supervisors adopt improved engineering and work practice controls that reduce the risk of sharps injuries. Precautions are always taken with sharp items. These include:
 - a. Plasticware is substituted for glassware whenever possible.
 - b. Use of needles and syringes or other sharp instruments is limited in the animal facility and is restricted to situations where there is no alternative (e.g., parenteral injection, blood collection, or aspiration of fluids from laboratory animals or diaphragm bottles). Active or passive needle-based safety devices are to be used whenever possible.
 - i. Uncapping of needles is performed in such a manner to reduce the potential for recoil causing an accidental needlestick.
 - ii. Needles are not bent, sheared, broken, recapped, removed from disposable syringes, or otherwise manipulated by hand before disposal.
 - iii. If absolutely necessary to remove a needle from a syringe (e.g., to prevent lysing blood cells) or recap a needle (e.g., loading syringes in one room and injecting animals in another), a hands-free device or comparable safety procedure must be used (e.g., a needle remover on a sharps container, or the use of forceps to hold the cap when recapping a needle).
 - iv. Used, disposable needles and syringes are carefully placed in puncture-resistant containers used for sharps disposal immediately after use. The sharps disposal container is located as close to the point of use as possible.
 - c. Non-disposable sharps (e.g., necropsy instruments such as forceps, pins, reusable scalpels) are placed in a hard-walled container for transport to a processing area for decontamination.
 - d. Broken glassware is not handled directly. Instead, it is removed using a brush and dustpan, tongs, or forceps.

16. All procedures are carefully performed to minimize the creation of aerosols or splatters of infectious materials and waste.
17. Decontaminate work surfaces after completion of work and after any spill or splash of potentially infectious material with appropriate disinfectant. Decontaminate all potentially infectious materials before transport or disposal using an effective method. Spills involving infectious materials are contained, decontaminated, and cleaned up by staff who are properly trained and equipped to work with infectious material. A spill procedure is developed and posted within the animal facility.
18. Decontaminate all cultures, stocks, and other potentially infectious materials before disposal using an effective method, consistent with applicable institutional, local and state requirements. Depending on where the decontamination will be performed, the following methods are used prior to transport:
 - a. Materials to be decontaminated outside of the immediate animal room are placed in a durable, leak-proof container and secured for transport. For infectious materials, the outer surface of the container is disinfected prior to moving materials and the transport container has a universal biohazard label.
 - b. Materials to be removed from the facility for decontamination are packed in accordance with applicable local, state, and federal regulations.
19. An effective integrated pest management program is required. See [Appendix G](#).
20. Animals and plants not associated with the work being performed are not permitted in the areas where infectious materials and/or animals are housed or manipulated.

B. Special Practices

1. Animal care staff are provided information on signs and symptoms of disease, receive occupational medical services including medical evaluation, surveillance, and treatment, as appropriate, and are offered available immunizations for agents handled or potentially present in the facility.
2. All procedures involving the manipulation of infectious materials that may generate an aerosol are conducted within a BSC or other physical containment device, when possible. If it is not possible to perform a procedure within a BSC or other physical containment device, a

combination of appropriate personal protective equipment, administrative and/or engineering controls (e.g., downdraft table) are used, based on a risk assessment.

- a. Restraint devices and practices that reduce the risk of exposure during animal manipulations (e.g., physical restraint, chemical restraint) are used whenever possible.
 - b. Equipment, cages, and racks are handled in a manner that minimizes contamination of other areas. Cages are decontaminated prior to washing.
3. Develop and implement an appropriate decontamination program in compliance with applicable institutional, local, and state requirements.
- a. Equipment is decontaminated before repair, maintenance, or removal from the animal facility. A method for decontaminating routine husbandry equipment and sensitive electronic or medical equipment is identified and implemented.
 - b. Decontamination of an entire animal room is considered when there has been gross contamination of the space, significant changes in usage, and for major renovations or maintenance shutdowns. Selection of the appropriate materials and methods used to decontaminate the animal room is based on the risk assessment.
 - c. Decontamination processes are verified on a routine basis.
4. Incidents that may result in exposure to infectious materials are immediately evaluated per institutional policies. All such incidents are reported to the animal facility supervisor and any other personnel designated by the institution. Appropriate records are maintained.

C. Safety Equipment (Primary Barriers and Personal Protective Equipment).

1. Properly maintained BSCs and other physical containment devices or equipment are used whenever conducting procedures with a potential for creating aerosols, splashes, or other potential exposures to hazardous materials. These include the necropsy of infected animals, harvesting of tissues or fluids from infected animals or eggs, and intranasal inoculation of animals. A risk assessment dictates the type of other physical containment devices used when BSCs may not be suitable.
 - a. When indicated by risk assessment, animals are housed in primary biosafety containment equipment appropriate for the animal species, such as solid wall and bottom cages covered with micro-isolator lids or other equivalent primary containment systems for larger animals.

- b. If used, actively ventilated caging systems are designed to contain microorganisms. Exhaust plenums for these systems are sealed. Safety mechanisms are in place to prevent the cage and exhaust plenums from becoming positively pressurized if the exhaust fan fails. The system is also alarmed to indicate operational malfunctions. Exhaust HEPA filters and filter housings are certified annually.
2. Protective clothing, such as gowns, uniforms, scrubs, or laboratory coats, and other PPE are worn while in the areas where infectious materials and/or animals are housed or manipulated.
 - a. Scrubs and uniforms are removed before leaving the animal facility.
 - b. Reusable clothing is appropriately contained and decontaminated before being laundered. Animal facility and protective clothing is never taken home.
 - c. Disposable PPE and other contaminated waste are appropriately contained and decontaminated prior to disposal.
3. Eye protection and face protection (e.g., safety glasses, goggles, mask, face shield, or other splatter guard) are used for manipulations or activities that may result in splashes or sprays from infectious or other hazardous materials when the animal or microorganisms is handled outside the BSC or another containment device. Eye protection and face protection are disposed of with other contaminated facility waste or decontaminated after use.
4. Persons having contact with NHPs assess the risk of mucous membrane exposure and wear protective equipment (e.g., face shield, surgical mask, goggles), as appropriate.
5. Additional PPE is considered for persons working with large animals.
6. Based on the pathogen and work performed, respiratory protection may be considered for staff enrolled in a properly constituted respiratory protection program.

D. Animal Facilities (Secondary Barriers)

1. ABSL-2 facilities should be separated from the general traffic patterns of the building and restricted, as appropriate. Consider placing animal areas away from exterior walls of buildings to minimize the impact from the outside environment temperatures.
 - a. External facility doors are self-closing and self-locking.
 - b. Access to the animal facility is restricted.
 - c. Doors to areas where infectious materials and/or animals are

housed open inward, are self-closing, are kept closed when experimental animals are present, and are never to be propped open. Doors to cubicles inside an animal room may open outward or slide horizontally or vertically.

2. A handwashing sink is located at the exit of the areas where infectious materials and/or animals are housed or manipulated. Additional sinks for handwashing are located in other appropriate locations within the facility. If the animal facility has segregated areas where infectious materials and/or animals are housed or manipulated, a sink is also available for handwashing at the exit from each segregated area.
 - a. Emergency eyewash and shower are readily available, easily accessible, and appropriately maintained.
 - b. Sink traps are filled with water and/or appropriate disinfectant to prevent the migration of vermin and gases.
 - c. If open floor drains are provided, the traps are filled with water and/or appropriate disinfectant or sealed to prevent the migration of vermin and gases.
3. The animal facility is designed, constructed, and maintained to facilitate cleaning and housekeeping. The interior surfaces (e.g., walls, floors, and ceilings) are water-resistant.
 - a. Floors are slip-resistant, impervious to liquids, and resistant to chemicals. Floors with drains are sloped toward drains to facilitate cleaning.
 - b. Penetrations in floors, walls, and ceiling surfaces are sealed, including openings around ducts, doors, doorframes, outlets, and switch plates to facilitate pest control and proper cleaning.
 - c. Internal facility fixtures, such as light fixtures, air ducts, and utility pipes, are designed and installed to minimize horizontal surface areas to facilitate cleaning and minimize the accumulation of debris or fomites.
 - d. External windows are not recommended; if present, they are sealed and resistant to breakage.
 - e. Illumination is adequate for all activities and avoids reflections and glare that could impede vision.
4. Furniture is minimized and can support anticipated loads and uses.
 - a. Benchtops are impervious to water and resistant to heat, organic solvents, acids, alkalis, and other chemicals.

- b. Chairs used in animal areas are covered with a non-porous material that can be easily cleaned and decontaminated with an appropriate disinfectant and sealed to prevent harboring of insects/vermin.
 - c. Equipment and furnishings are carefully evaluated to minimize exposure of personnel to pinch points and sharp edges and corners.
5. Ventilation is provided in accordance with the *Guide for the Care and Use of Laboratory Animals*.³
- a. Ventilation system design considers the heat and high moisture load produced during the cleaning of animal rooms and the cage wash process.
 - b. The direction of airflow into the animal facility is inward; animal rooms maintain inward directional airflow compared to adjoining hallways.
 - c. A ducted exhaust air ventilation system is provided.
 - d. Exhaust air is discharged to the outside without being recirculated to other rooms.
6. Mechanical cage washers have a final rinse temperature of at least 180°F. The cage wash area is designed to accommodate the use of high-pressure spray systems, humidity, strong chemical disinfectants, and 180°F water temperatures during the cage/equipment cleaning process.
7. BSCs and other primary containment barrier systems are installed and operated in a manner to ensure their effectiveness. See [Appendix A](#).
- a. BSCs are installed so that fluctuations of the room air supply and exhaust do not interfere with proper operations. BSCs are located away from doors, windows that can be opened, heavily traveled areas, and other possible airflow disruptions.
 - b. BSCs can be connected to the animal facility exhaust system by either a canopy connection (Class IIA only) or directly exhausted to the outside through a hard connection (Class IIB, IIC, or III). Class IIA or IIC BSC exhaust can be safely recirculated back into the animal facility environment if no volatile toxic chemicals are used in the cabinet.
 - c. BSCs are certified at least annually to ensure correct performance, or as specified in [Appendix A, Part 7](#).
8. Vacuum lines in use are protected with liquid disinfectant traps and in-line HEPA filters or their equivalent. See [Appendix A, Figure 11](#). Filters

are replaced, as needed, or on a replacement schedule determined by a risk assessment.

9. An autoclave is present in the animal facility to facilitate decontamination of infectious materials and waste. A validated alternative process (e.g., alkaline digestion, incineration) may be used for decontamination and disposal of carcasses.

Animal Biosafety Level 3

Animal Biosafety Level 3 (ABSL-3) involves practices suitable for work with laboratory animals infected with indigenous or exotic agents, agents that present a potential for aerosol transmission, and agents causing serious or potentially lethal disease. ABSL-3 builds upon the standard practices, procedures, containment equipment, and facility requirements of ABSL-2.

The ABSL-3 facility has special engineering and design features.

ABSL-3 requires that in addition to the requirements for ABSL-2, all procedures are conducted in BSCs or by use of other physical containment equipment. Inward airflow at the containment boundary is maintained. Handwashing sinks are capable of hands-free operation.

Appropriate PPE is worn to reduce exposure to infectious agents, animals, and contaminated equipment.

The following standard and special safety practices, safety equipment, and facility specifications are necessary for ABSL-3.

A. Standard Microbiological Practices

1. The animal facility director establishes and enforces policies, procedures, and protocols for biosafety, biosecurity, and emergencies within the animal facility.
2. Access to the animal room is limited. Only those persons required for experimental, husbandry, or support purposes are authorized to enter the facility.
3. Each institution ensures that worker safety and health concerns are addressed as part of the animal protocol review process. Consideration is given to specific biohazards unique to the animal species and protocol in use. Prior to beginning a study, animal protocols are also reviewed and approved by the Institutional Animal Care and Use Committee (IACUC) and the Institutional Biosafety Committee (IBC), or equivalent resource, as appropriate.

4. The supervisor ensures that animal care, facility, and support personnel receive appropriate training regarding their duties, animal husbandry procedures, potential hazards, manipulations of infectious agents, necessary precautions to minimize exposures, and hazard/exposure evaluation procedures (e.g., physical hazards, splashes, aerosolization). Personnel receive annual updates and additional training when equipment, procedures, or policies change. Records are maintained for all hazard evaluations, training sessions, and staff attendance. All persons, including facility equipment personnel, service workers, and visitors, are advised of the potential hazards (e.g., naturally acquired or research pathogens, allergens); are instructed on the appropriate safeguards; and read and follow instructions on practices and procedures. An institutional policy regarding visitor training, occupational health requirements, and safety communication is considered.
5. Personal health status may affect an individual's susceptibility to infection, ability to receive available immunizations or prophylactic interventions. Therefore, all personnel, and particularly those of reproductive age and/or those having conditions that may predispose them to increased risk for infection (e.g., organ transplant, medical immunosuppressive agents), are provided information regarding immune competence and susceptibility to infectious agents. Individuals having such conditions are encouraged to self-identify to the institution's healthcare provider for appropriate counseling and guidance. See [Section VII](#). Facility supervisors ensure that medical staff are informed of potential occupational hazards within the animal facility, to include those associated with research, animal husbandry duties, animal care, and manipulations.
6. Appropriate occupational medical services are in place, as determined by risk assessment.
 - a. An animal allergy prevention program is part of the medical surveillance.
 - b. Personnel using respirators for animal allergy prevention are enrolled in an appropriately constituted respiratory protection program.
7. A safety manual specific to the facility is prepared or adopted in consultation with the facility director and appropriate safety professionals. The safety manual is available, accessible, and periodically reviewed and updated as necessary.

- a. The safety manual contains sufficient information to describe the biosafety and containment procedures for the experimental animals, organisms, biological materials in use, and the work performed.
 - b. The safety manual contains or references protocols for emergency situations, including exposures, medical emergencies, facility malfunctions, escape of animals within the animal facility, and other potential emergencies. A plan for the disposition of animals during emergency situations is included. Training in emergency response procedures is provided to emergency response personnel and other responsible staff according to institutional policies.
8. A sign is posted at the entrance to the animal room when infectious agents are present. Posted information includes: the universal biohazard symbol, the room's Animal Biosafety Level, the supervisor's or other responsible personnel's name and telephone number, PPE requirements, general occupational health requirements (e.g., immunization, respiratory protection), and required procedures for entering and exiting the animal room. Agent information is posted in accordance with the institutional policy.
 9. Long hair is restrained so that it cannot contact hands, animals, specimens, containers, or equipment.
 10. Gloves are worn to protect hands from exposure to hazardous materials and when handling animals.
 - a. Glove selection is based on an appropriate risk assessment.
 - b. Consider the need for bite and/or scratch-resistant gloves.
 - c. Gloves worn inside the animal facility are not worn outside the animal facility.
 - d. Change gloves when contaminated, glove integrity is compromised, or when otherwise necessary.
 - e. Do not wash or reuse disposable gloves, and dispose of used gloves with other contaminated facility waste.
 11. Gloves and other PPE are removed in a manner that minimizes personal contamination and transfer of infectious materials outside of the areas where infectious materials and/or animals are housed or manipulated.
 12. Persons wash their hands after handling animals and before leaving the areas where infectious materials and/or animals are housed or manipulated.

13. Eating, drinking, smoking, handling contact lenses, applying cosmetics, and storing food for human consumption are not permitted in animal areas.
14. Mouth pipetting is prohibited. Mechanical pipetting devices are used.
15. Policies for the safe handling of sharps, such as needles, scalpels, pipettes, and broken glassware are developed, implemented, and followed; policies are consistent with applicable state, federal, and local requirements. Whenever practical, supervisors adopt improved engineering and work practice controls that reduce the risk of sharps injuries. Precautions are always taken with sharp items. These include:
 - a. Plasticware is substituted for glassware whenever possible.
 - b. Use of needles and syringes or other sharp instruments is limited in the animal facility and is restricted to situations where there is no alternative (e.g., parenteral injection, blood collection, or aspiration of fluids from laboratory animals or diaphragm bottles). Active or passive needle-based safety devices are to be used whenever possible.
 - i. Uncapping of needles is performed in such a manner to reduce the potential for recoil causing an accidental needlestick.
 - ii. Needles are not bent, sheared, broken, recapped, removed from disposable syringes, or otherwise manipulated by hand before disposal.
 - iii. If absolutely necessary to remove a needle from a syringe (e.g., to prevent lysing blood cells) or recap a needle (e.g., loading syringes in one room and injecting animals in another), a hands-free device or comparable safety procedure must be used (e.g., a needle remover on a sharps container, or the use of forceps to hold the cap when recapping a needle).
 - iv. Used, disposable needles and syringes are carefully placed in puncture-resistant containers used for sharps disposal immediately after use. The sharps disposal container is located as close to the point of use as possible.
 - c. Non-disposable sharps (e.g., necropsy instruments such as forceps, pins, reusable scalpels) are placed in a hard-walled container for transport to a processing area for decontamination.
 - d. Broken glassware is not handled directly. Instead, it is removed using a brush and dustpan, tongs, or forceps.

16. All procedures are carefully performed to minimize the creation of aerosols or splatters of infectious materials and waste.
17. Decontaminate work surfaces after completion of work and after any spill or splash of potentially infectious material with appropriate disinfectant. Spills involving infectious materials are contained, decontaminated, and cleaned up by staff who are properly trained and equipped to work with infectious material. A spill procedure is developed and posted within the animal facility.
18. Decontaminate all cultures, stocks, and other potentially infectious materials before disposal using an effective method, consistent with applicable institutional, local and state requirements. Depending on where the decontamination will be performed, the following methods are used prior to transport:
 - a. Materials to be decontaminated outside of the immediate animal room are placed in a durable, leak-proof container and secured for transport. For infectious materials, the outer surface of the container is disinfected prior to moving materials and the transport container has a universal biohazard label.
 - b. Materials to be removed from the facility for decontamination are packed in accordance with applicable local, state, and federal regulations.
19. An effective integrated pest management program is required. See [Appendix G](#).
20. Animals and plants not associated with the work being performed are not permitted in the areas where infectious materials and/or animals are housed or manipulated.

B. Special Practices

1. Animal care staff are provided information on signs and symptoms of disease, receive occupational medical services including medical evaluation, surveillance, and treatment as appropriate, and are offered available immunizations for agents handled or potentially present in the facility.
2. A system is established for reporting and documenting near misses, animal facility accidents, exposures, unanticipated absences due to potential Laboratory-associated infection, and for the medical surveillance of potential laboratory-associated illnesses.
3. Incidents that result in exposure to infectious materials are immediately evaluated per institutional policy. All such incidents are reported to the animal facility director, facility supervisor, institutional management, and

appropriate facility safety, compliance, and security personnel according to institutional policy. Appropriate records are maintained.

4. Only necessary equipment and supplies are recommended to be taken inside the animal facility.
5. All procedures involving the manipulation of infectious materials are conducted within a BSC or other physical containment device, when possible. If it is not possible to perform a procedure within a BSC or other physical containment device, a combination of appropriate personal protective equipment, administrative and/or engineering controls (e.g., downdraft table) are used, based on a risk assessment.
 - a. Restraint devices and practices that reduce the risk of exposure during animal manipulations (e.g., physical restraint, chemical restraint) are used whenever possible.
 - b. Equipment, cages, and racks are handled in a manner that minimizes contamination of other areas.
6. Biological materials that are to remain in a viable state during removal from the animal facility are placed in a durable leak-proof sealed primary container and then enclosed in a non-breakable, sealed secondary container prior to removal from the facility by authorized personnel. Once removed, the primary container is opened within a BSC in BSL-3 or ABSL-3 containment unless a validated inactivated method is used. See [Appendix K](#). The inactivation method is documented in-house with viability testing data to support the method.
7. Develop and implement an appropriate decontamination program in compliance with applicable institutional, local, state, and federal requirements.
 - a. Equipment is decontaminated before repair, maintenance, or removal from the areas where infectious materials and/or animals are housed or manipulated. A method for decontaminating routine husbandry equipment and sensitive electronic or medical equipment is identified and implemented.
 - b. Decontamination of an entire animal room is considered when there has been gross contamination of the space, significant changes in usage, major renovations, or maintenance shutdowns. Selection of the appropriate materials and methods used to decontaminate the animal room is based on the risk assessment.
 - c. Decontamination processes are verified on a routine basis.

C. Safety Equipment (Primary Barriers and Personal Protective Equipment)

1. Properly maintained BSCs and other physical containment devices or equipment are used for manipulations of infectious materials and animals as determined by risk assessment.
 - a. The risk of infectious aerosols from infected animals or their bedding can be reduced if animals are housed in containment caging systems, such as solid wall and bottom cages covered with micro-isolator lids, open cages placed in inward flow ventilated enclosures, HEPA filter isolators and caging systems, or other equivalent primary containment systems.
 - i. Actively ventilated caging systems are designed to prevent the escape of microorganisms from the cage. Exhaust plenums for these systems are sealed to prevent the escape of microorganisms if the ventilation system becomes static, and the exhaust is HEPA-filtered. Safety mechanisms are in place to prevent the cage and exhaust plenums from becoming positive to the surrounding area should the exhaust fan fail. The system is alarmed to indicate operational malfunctions.
 - b. When animals cannot be housed in ventilated containment cages/units, certain features of the animal room act as the primary barriers. The procedures in place include how workers are protected from agents shed by the animals (e.g., PPE enhancements) as well as how the environment is protected from such agents through the use of biocontainment enhancements such as some combination of boot or PPE change or surface decontamination at the door, a personal shower at the room level, and/or other procedures.
2. Special consideration is given to the potential for cross-contamination when open caging is used. See [Appendix D](#) for additional information.
3. Personnel within the animal facility wear protective clothing, such as uniforms or scrubs.
 - a. Disposable PPE such as non-woven, olefin cover-all suits, or wrap-around or solid-front gowns are worn over this clothing before entering areas where infectious materials and/or animals are housed or manipulated. Front-button, laboratory coats are unsuitable.
 - b. Reusable clothing is appropriately contained and decontaminated before being laundered. Animal facility and protective clothing is never taken home.

- c. Disposable PPE is removed when leaving the areas where infectious materials and/or animals are housed or manipulated. Scrubs and uniforms are removed before leaving the animal facility.
 - d. Disposable PPE and other contaminated waste are appropriately contained and decontaminated prior to disposal.
4. All personnel entering areas where infectious materials and/or animals are housed or manipulated wear appropriate head covering, eye, face, and respiratory protection. To prevent cross-contamination, boots, shoe covers, or other protective footwear are used where indicated and disposed of or decontaminated after use.
 5. Head covering, eye protection, and face protection are disposed of with other contaminated animal facility waste or decontaminated after use.
 6. Procedures may require wearing two pairs of gloves (i.e., double-glove). Change outer gloves when contaminated, glove integrity is compromised, or when otherwise necessary.
 7. Additional PPE is considered for persons working with large animals.

D. Animal Facilities (Secondary Barriers)

1. ABSL-3 facilities should be separated from the general traffic patterns of the building and restricted as appropriate. Consider placing animal areas away from exterior walls of buildings to minimize the impact from the outside environment temperatures.
 - a. External facility doors are self-closing and self-locking.
 - b. Access to the animal facility is restricted.
 - c. Doors to areas where infectious materials and/or animals are housed open inward, are self-closing, are kept closed when experimental animals are present, and are never propped open.
 - d. Entry into the containment area is via a double-door entry, which constitutes an anteroom/airlock and a change room. Exit showers may be considered based on risk assessment. An additional double-door anteroom or double-doored autoclave may be provided for movement of supplies and wastes into and out of the facility.
2. A handwashing sink is located at the exit of the areas where infectious materials and/or animals are housed or manipulated. Additional sinks for handwashing are located in other appropriate locations within the facility. If the animal facility has segregated areas where infectious materials and/or animals are housed or manipulated, a handwashing sink is also available near the exit from each segregated area.

- a. The sink is hands-free or automatically operated.
 - b. Emergency eyewash and shower are readily available, easily accessible, and appropriately maintained.
 - c. Sink traps are filled with water and/or appropriate disinfectant or sealed to prevent the migration of vermin and gases.
 - d. Floor drains are maintained and filled with water and/or appropriate disinfectant or sealed to prevent the migration of vermin and gases.
3. The animal facility is designed, constructed, and maintained to facilitate cleaning, decontamination, and housekeeping. The interior surfaces (e.g., walls, floors, and ceilings) are water-resistant.
- a. Floors are slip-resistant, impervious to liquids, and resistant to chemicals. Flooring is seamless, sealed, or poured with integral cove bases. Floors slope to drain, if present.
 - b. Penetrations in floors, walls, and ceiling surfaces are sealed, including openings around ducts, outlets, switch plates, and doorframes, to facilitate pest control, proper cleaning, and decontamination. Walls, floors, and ceilings form a sanitizable and sealed surface.
 - c. Internal facility fixtures, such as light fixtures, air ducts, and utility pipes, are designed and installed to minimize horizontal surface areas to facilitate cleaning and minimize the accumulation of debris or fomites.
 - d. External windows are not recommended; if present, they are sealed and resistant to breakage.
 - e. Illumination is adequate for all activities and avoids reflections and glare that could impede vision.
4. Furniture is minimized and can support anticipated loads and uses.
- a. Benchtops are impervious to water and resistant to heat, organic solvents, acids, alkalis, and other chemicals.
 - b. Chairs used in animal areas are covered with a non-porous material that can be easily cleaned and decontaminated with an appropriate disinfectant and sealed to prevent harboring of insects/vermin.
 - c. Equipment and furnishings are carefully evaluated to minimize exposure of personnel to pinch points and sharp edges and corners.

5. Ventilation is provided in accordance with the Guide for the Care and Use of Laboratory Animals.³
 - a. Ventilation system design considers the heat and high moisture load produced during the cleaning of animal rooms and the cage wash process.
 - b. The direction of airflow into the animal facility is inward; animal rooms maintain inward directional airflow compared to adjoining hallways. A visual monitoring device, which confirms directional airflow, is provided at the animal room entrance.
 - c. A ducted exhaust air ventilation system is provided. Exhaust air is discharged to the outside without being recirculated to other rooms. This system creates directional airflow, which draws air into the animal room from “clean” areas and toward “contaminated” areas.
 - d. The exhaust air is dispersed away from occupied areas and from building air intake locations or the exhaust air is HEPA-filtered.
 - e. The ABSL-3 animal facility is designed such that under failure conditions the airflow will not be reversed at the containment barrier. Alarms are considered to notify personnel of ventilation and HVAC system failure.
6. Cages are decontaminated prior to removal from the containment barrier and prior to washing in a mechanical cage washer. The cage wash area is designed to accommodate the use of high-pressure spray systems, humidity, strong chemical disinfectants, and 180°F water temperatures during the cage/equipment cleaning process.
7. BSCs and other primary containment barrier systems are installed and operated in a manner to ensure their effectiveness. See [Appendix A](#).
 - a. BSCs are installed so that fluctuations of the room air supply and exhaust do not interfere with proper operations. BSCs are located away from doors, windows that can be opened, heavily traveled areas, and other possible airflow disruptions.
 - b. BSCs can be connected to the animal facility exhaust system by either a canopy connection (Class IIA only) or directly exhausted to the outside through a hard connection (Class IIB, IIC, or III). Class IIA or IIC BSC exhaust can be safely recirculated back into the animal facility environment if no volatile toxic chemicals are used in the cabinet.

- c. BSCs are certified at least annually to ensure correct performance, or as specified in [Appendix A, Part 7](#).
 - d. Class III BSCs are provided supply air in such a manner that prevents positive pressurization of the cabinet or the animal room.
8. Equipment that may produce infectious aerosols is contained in primary barrier devices that exhaust air through HEPA filtration, or other equivalent technology, before being discharged into the animal facility. These HEPA filters are tested annually and replaced as needed.
 9. All vacuum lines are protected with HEPA filters, or their equivalent, or are capped. Vacuum lines in use are protected with liquid disinfectant traps and in-line HEPA filters or their equivalent. See [Appendix A, Figure 11](#). Filters are replaced, as needed, or are on a replacement schedule determined by a risk assessment. The placement of an additional HEPA filter immediately prior to a central vacuum pump is considered.
 10. An autoclave is available within the containment barrier. The autoclave is utilized to decontaminate infectious materials and waste before moving these materials to the other areas of the facility. If not within the containment barrier, special practices are developed for the transport of infectious materials to designated alternate locations for decontamination. A validated alternative process (e.g., alkaline digestion, incineration) may be used for decontamination and disposal of carcasses.
 11. The ABSL-3 facility design, operational parameters, and procedures are verified and documented prior to operation. Facilities are tested annually or after significant modification to ensure operational parameters are met. Verification criteria are modified as necessary by operational experience.
 12. Enhanced environmental and personal protection may be necessary based on risk assessment and applicable local, state, or federal regulations. These enhancements may include one or more of the following: an anteroom for clean storage of equipment and supplies with dress-in, shower-out capabilities; gas-tight dampers to facilitate animal room isolation; final HEPA filtration of the animal room exhaust air; animal room effluent decontamination; containment of other piped services; or advanced access control devices, such as biometrics.

Animal Biosafety Level 4

Animal Biosafety Level 4 (ABSL-4) is required for work with animals infected with dangerous and exotic agents that pose a high individual risk of aerosol-transmitted laboratory infections and life-threatening diseases that are frequently fatal, agents for which there are no vaccines or treatments, or work with a related agent with unknown risk of transmission. Agents with a close or identical antigenic relationship to agents requiring ABSL-4 containment are handled at this level until sufficient data are obtained to re-designate the level. Animal care staff receive specific and thorough training in handling extremely hazardous, infectious agents and infected animals. Animal care staff understand the primary and secondary containment functions of standard and special practices, containment equipment, and facility design characteristics. All animal care staff and supervisors are competent in handling animals, agents, and procedures requiring ABSL-4 containment. The animal facility director and/or supervisor control(s) access to the ABSL-4 animal facility in accordance with institutional policies.

There are two models for ABSL-4 facilities:

1. **Cabinet Facility:** All handling of agents, infected animals, and housing of infected animals is performed in Class III BSCs. See [Appendix A](#); and
2. **Suit Facility:** Personnel wear a positive-pressure suit. The animal room maintains negative pressure relative to the surrounding areas and have HEPA-filtered supply and exhaust systems. A site-specific risk assessment that considers the agent, the potential for agent shedding, and aerosol generation from infected animals is conducted to determine appropriate animal housing. Most infected animals are housed in a primary containment system and handled under a primary barrier system such as a Class II BSC or another containment system.

ABSL-4 builds upon the standard practices, procedures, containment equipment, and facility requirements of ABSL-3. However, ABSL-4 cabinet and suit facilities have special engineering and design features to prevent microorganisms from dissemination into the environment and to protect personnel.

The ABSL-4 cabinet facility is distinctly different from an ABSL-3 facility containing a Class III BSC.

The following standard and special practices, safety equipment, and facility specifications are necessary for ABSL-4.

A. Standard Microbiological Practices

1. The animal facility director establishes and enforces policies, procedures, and protocols for biosafety, biosecurity, and emergencies within the animal facility.

2. Access to the animal room is limited. Only those persons required for experimental, husbandry, or support purposes are authorized to enter the facility.
3. Each institution ensures that worker safety and health concerns are addressed as part of the animal protocol review process. Consideration is given to specific biohazards unique to the animal species and protocol in use. Prior to beginning a study, animal protocols are also reviewed and approved by the Institutional Animal Care and Use Committee (IACUC) and the Institutional Biosafety Committee (IBC), or equivalent resource, as appropriate.
4. The supervisor ensures that animal care, facility, and support personnel receive appropriate training regarding their duties, animal husbandry procedures, potential hazards, manipulations of infectious agents, necessary precautions to minimize exposures, and hazard/exposure evaluation procedures (e.g., physical hazards, splashes, aerosolization). Personnel receive annual updates and additional training when equipment, procedures or policies change. Records are maintained for all hazard evaluations, training sessions, and staff attendance. All persons, including facility equipment personnel, service workers, and visitors, are advised of the potential hazards (e.g., naturally acquired or research pathogens, allergens); are instructed on the appropriate safeguards; and read and follow instructions on practices and procedures. An institutional policy regarding visitor training, occupational health requirements, and safety communication is considered.
5. Personal health status may affect an individual's susceptibility to infection and ability to receive available immunizations or prophylactic interventions. Therefore, all personnel, and particularly those of reproductive age and/or those having conditions that may predispose them to increased risk for infection (e.g., organ transplant, medical immunosuppressive agents), are provided information regarding immune competence and susceptibility to infectious agents. Individuals having such conditions are encouraged to self-identify to the institution's healthcare provider for appropriate counseling and guidance. See [Section VII](#). Facility supervisors ensure that medical staff are informed of potential occupational hazards within the animal facility, to include those associated with research, animal husbandry duties, animal care, and manipulations.
6. Appropriate occupational medical services are in place, as determined by risk assessment.

- a. An animal allergy prevention program is part of the medical surveillance.
 - b. Personnel using respirators for animal allergy prevention are enrolled in an appropriately constituted respiratory protection program.
7. A safety manual specific to the facility is prepared or adopted in consultation with the facility director and appropriate safety professionals. The safety manual is available, accessible, and periodically reviewed and updated as necessary.
- a. The safety manual contains sufficient information to describe the biosafety and containment procedures for the experimental animals, organisms and biological materials in use, appropriate agent-specific decontamination methods, and the work performed.
 - b. The safety manual contains or references protocols for emergency situations, including exposures, medical emergencies, facility malfunctions, escape of animals within the animal facility, and other potential emergencies. A plan for the disposition of animals during emergency situations is included. Training in emergency response procedures is provided to emergency response personnel and other responsible staff according to institutional policies.
8. A sign is posted at the entrance to the animal room when infectious agents are present. Posted information includes: the universal biohazard symbol, the room's Animal Biosafety Level, the supervisor's or other responsible personnel's name and telephone number, general occupational health requirements (e.g., immunization, respiratory protection), PPE requirements and required procedures for entering and exiting the animal room. Agent information is posted in accordance with the institutional policy.
9. Gloves are worn to protect hands from exposure to hazardous materials and when handling animals.
- a. Glove selection is based on an appropriate risk assessment.
 - b. Inner gloves worn inside the animal facility are not worn outside the animal facility.
 - c. Change inner gloves when contaminated, glove integrity is compromised, or when otherwise necessary.
 - d. Do not wash or reuse disposable gloves, and dispose of used gloves with other contaminated animal facility waste.

10. Gloves and other PPE are removed in a manner that minimizes personal contamination and transfer of infectious materials outside of the areas where infectious materials and/or animals are housed or manipulated.
11. Eating, drinking, smoking, handling contact lenses, applying cosmetics, and storing food for human consumption are not permitted in animal areas.
12. Mouth pipetting is prohibited. Mechanical pipetting devices are used.
13. Policies for the safe handling of sharps, such as needles, scalpels, pipettes, and broken glassware are developed, implemented, and followed; policies are consistent with applicable state, federal, and local requirements. Whenever practical, supervisors adopt improved engineering and work practice controls that reduce the risk of sharps injuries. Precautions are always taken with sharp items. These include:
 - a. Plasticware is substituted for glassware whenever possible.
 - b. Use of needles and syringes or other sharp instruments is limited in the animal facility and is restricted to situations where there is no alternative (e.g., parenteral injection, blood collection, or aspiration of fluids from laboratory animals or diaphragm bottles). Active or passive needle-based safety devices are to be used whenever possible.
 - i. Uncapping of needles is performed in such a manner to reduce the potential for recoil causing an accidental needlestick.
 - ii. Needles are not bent, sheared, broken, recapped, removed from disposable syringes, or otherwise manipulated by hand before disposal.
 - iii. If absolutely necessary to remove a needle from a syringe (e.g., to prevent lysing blood cells) or recap a needle (e.g., loading syringes in one room and injecting animals in another), a hands-free device or comparable safety procedure must be used (e.g., a needle remover on a sharps container, or the use of forceps to hold the cap when recapping a needle).
 - iv. Used, disposable needles and syringes are carefully placed in puncture-resistant containers used for sharps disposal immediately after use. The sharps disposal container is located as close to the point of use as possible.
 - c. Non-disposable sharps (e.g., necropsy instruments such as forceps, pins, reusable scalpels) are placed in a hard-walled container for transport to a processing area for decontamination.

- d. Broken glassware is not handled directly. Instead, it is removed using a brush and dustpan, tongs, or forceps.
14. All procedures are carefully performed to minimize the creation of aerosols or splatters of infectious materials and waste.
15. Decontaminate work surfaces after completion of work and after any spill or splash of potentially infectious material with appropriate disinfectant. Spills involving infectious materials are contained, decontaminated, and cleaned up by staff who are properly trained and equipped to work with infectious material. A spill procedure is developed and posted within the animal facility.
16. All wastes from the animal room, including animal tissues, carcasses, and bedding are transported from the animal room in leak-proof, covered containers for appropriate disposal consistent with applicable institutional, local, and state requirements. See B. Special Practices, #7 in the following sub-section for additional details.
17. An effective integrated pest management program is required. See [Appendix G](#).
18. Animals and plants not associated with the work being performed are not permitted in the areas where infectious materials and/or animals are housed or manipulated.

B. Special Practices

1. All persons entering the animal facility are advised of the potential hazards and meet specific entry/exit requirements in accordance with institutional policies. Only persons whose presence in the facility or individual animal rooms is required for scientific or support purposes are authorized to enter. Additional training/security requirements may be required prior to gaining independent access to the animal facility.
2. All persons who enter operational animal areas are provided information on signs and symptoms of disease and receive occupational medical services including medical evaluation, surveillance, and treatment, as appropriate, and offered available immunizations for agents handled or potentially present in the facility.
 - a. An essential adjunct to such an occupational medical services system is the availability of a facility for the isolation and medical care of personnel with potential or known Laboratory-associated infections.
3. The facility supervisor is responsible for ensuring that, prior to working independently in ABSL-4 containment, personnel demonstrate high

proficiency in standard and special microbiological practices, and techniques for working with agents requiring ABSL-4 containment.

4. A system is established for reporting and documenting near misses, accidents, exposures, unanticipated absences due to potential Laboratory-associated infection, and for the medical surveillance of potential laboratory-associated illnesses.
5. Incidents that may result in exposure to infectious materials are immediately evaluated per institutional policy. All incidents are reported to the animal facility director, facility supervisor, institutional management, and appropriate facility safety, compliance, and security personnel according to institutional policy. Appropriate records are maintained.
6. Biological materials that are to remain in a viable state during removal from the animal facility are placed in a durable leak-proof sealed primary container and then enclosed in a non-breakable, sealed secondary container prior to removal from the facility by authorized personnel. These materials are transferred through a disinfectant dunk tank, fumigation chamber, or decontamination shower. Once removed, the primary container is not opened outside BSL-4 or ABSL-4 containment unless a validated inactivation method is used (e.g., gamma irradiation). See [Appendix K](#). The inactivation method is documented in-house with viability testing data to support the method.
7. All wastes (including animal tissues, carcasses, and contaminated bedding) and other materials are decontaminated by a verified method before removal from the ABSL-4 facility.
8. Equipment is routinely decontaminated and is decontaminated before repair, maintenance, or removal from the animal facility. Equipment, cages, and racks are handled in a manner that minimizes contamination of other areas. Cages are autoclaved or thoroughly decontaminated before they are cleaned and washed.
 - a. Equipment (e.g., sensitive electronic, medical, or routine husbandry equipment) or material that might be damaged by high temperatures or steam is decontaminated using an effective and verified procedure such as a gaseous or vapor method in a sealable airlock or chamber designed for this purpose.
9. Procedures to reduce possible worker exposure are instituted, such as use of squeeze cages, working only with anesthetized animals, or other appropriate practices. Personnel assigned to work with infected animals may be required to work in pairs as directed by institutional policies.

10. A logbook, or other means of documenting the date and time of all persons entering and leaving the animal facility, is maintained.
11. While the facility is operational, personnel enter and exit the animal facility through the clothing change and shower rooms except during emergencies. All personal clothing and jewelry (except eyeglasses) are removed in the outer clothing change room. All persons entering the facility use animal facility clothing, including undergarments, pants, shirts, jumpsuits, shoes, and gloves, as appropriate. All persons leaving the animal facility are required to take a personal body shower. Used animal facility clothing and other waste, including gloves, are treated as contaminated materials and decontaminated before laundering or disposal.
12. After the facility has been completely decontaminated by verification of a validated method, necessary staff may enter and exit the animal facility without following the clothing change and shower requirements described above.
13. Daily inspections of essential containment and life support systems are completed and documented before laboratory work is initiated to ensure that the animal rooms and animal facilities are operating according to established parameters.
14. Only necessary equipment and supplies are stored inside the animal facility. All equipment and supplies taken inside the facility are decontaminated before removal from the laboratory.
 - a. Supplies and materials that are not brought into the animal facility through the change room are brought in through a dunk tank, previously decontaminated double-door autoclave, fumigation chamber, or airlock. After securing the outer doors, personnel within the laboratory retrieve the materials by opening the interior doors of the autoclave, fumigation chamber, or airlock. The inner door is secured after materials are brought into the facility. The outer door of the autoclave or fumigation chamber is not opened until the autoclave, fumigation chamber, or airlock has been operated through a successful decontamination cycle.

C. Safety Equipment (Primary Barriers and Personal Protective Equipment)

Cabinet Facility

1. All procedures involving the manipulation of infectious animals and materials are conducted within a Class III BSC.

2. A Class III BSC contains:
 - a. Double-door, pass-through autoclave for decontaminating materials passing out of the Class III BSC(s). The autoclave doors are interlocked so that only one door can be opened at any time and are automatically controlled so that the outside door to the autoclave can only be opened after a successful decontamination cycle has been completed.
 - b. A pass-through dunk tank, fumigation chamber, or equivalent decontamination method so that materials and equipment that cannot be decontaminated in the autoclave can be safely removed from the cabinet. Containment between the cabinet and the surrounding animal room is maintained at all times.
 - c. A HEPA filter on the supply air intake and two HEPA filters in series on the exhaust outlet of the unit. Supply air is provided in such a manner that prevents positive pressurization of the cabinet. There are gas-tight dampers on the supply and exhaust ducts of the cabinet to permit gas or vapor decontamination of the unit. Ports for injection of test medium are present on all HEPA filter housings for annual filter recertification.
 - d. An interior constructed with smooth finishes that can be easily cleaned and decontaminated. All sharp edges on cabinet finishes are eliminated to reduce the potential for cuts and tears of the cabinet gloves. Equipment to be placed in the Class III BSC is also free of sharp edges or other surfaces that may damage or puncture the cabinet gloves.
 - e. Class III cabinet gloves are inspected for leaks periodically and changed if necessary. Gloves are replaced annually during cabinet recertification.
3. The cabinet is designed to permit maintenance and repairs of cabinet mechanical systems (e.g., refrigeration, incubators, centrifuges) to be performed from the exterior of the cabinet whenever possible.
4. Manipulation of high concentrations or large volumes of infectious agents within the Class III BSC is performed using physical containment devices inside the cabinet whenever practical. Such materials are centrifuged inside the cabinet using sealed rotors or centrifuge safety cups.
5. The interior of the Class III BSC and all contaminated plenums, fans, and filters are decontaminated using a validated gaseous or vapor method when there have been significant changes in cabinet usage, before major renovations or maintenance shutdowns, and in other situations,

as determined by risk assessment. Success of the decontamination is verified before accessing the interior spaces of the cabinet.

6. The Class III BSC is certified at least annually.
7. For Class III BSCs directly connected via a double door pass through to an ABSL-4 suit facility, materials may be placed into and removed from the Class III BSC via the suit facility.
8. Restraint devices and practices that reduce the risk of exposure during animal manipulations are used where practicable (e.g., physical restraint devices, chemical restraint medications, mesh, or Kevlar gloves).
9. Workers in the animal facility wear protective animal facility clothing with a solid front, such as tie-back or wrap-around gowns, scrubs, or coveralls. Additional PPE may be required based on risk assessment.
 - a. Upon exit, all protective clothing is removed in the inner change room before showering.
 - b. Prescription eyeglasses are decontaminated before removal through the personal body shower.
10. Disposable gloves are worn underneath cabinet gloves to protect the worker from exposure should a break or tear occur in a cabinet glove.

Suit Facility

1. All procedures involving the manipulation of infectious materials or infected animals are conducted within a BSC or other physical containment devices.
2. Infected animals are housed in a primary containment system. Primary containment systems include: actively ventilated caging systems; open cages placed in ventilated enclosures; solid wall and bottom cages covered with micro-isolator lids and opened in laminar flow hoods or HEPA-filtered downdraft tables; or other equivalent primary containment systems.
 - a. Actively ventilated caging systems are designed to prevent the escape of microorganisms from the cage. Exhaust plenums for these systems are sealed to prevent the escape of microorganisms if the ventilation system becomes static, and the exhaust is HEPA-filtered. These HEPA filters are tested annually and replaced as needed. Safety mechanisms are in place to prevent the cage and exhaust plenums from becoming positive to the surrounding area should the exhaust fan fail. The system is alarmed to indicate operational malfunctions.

3. Infected animals may be housed in open cages within a dedicated animal-holding room that serves as the primary barrier. A room serving as a primary barrier is air-tight and capable of being decontaminated using fumigation. If animals are to be contained in a dedicated animal-holding room serving as the primary barrier, the following conditions are met:
 - a. Prior to fumigation of the animal-holding room, cages may be removed for autoclaving or chemical decontamination.
 - b. Caging is chosen to reduce the amount of animal detritus that can be thrown out of the cage and onto the floor of the animal holding room.
 - c. The flow of personnel, material, and equipment is directed in order to minimize the spread of contamination from the animal-holding room into adjacent areas of the animal facility.
4. When large animals cannot be housed in a primary containment system or ventilated containment cages/units, certain features of the animal room (e.g., HEPA exhaust filters and the sealed and pressure-tested room surfaces) act as the primary barriers.
 - a. Loose-housed or open penned animals may require ABSL-3Ag or ABSL-4Ag containment. See [Appendix D](#) for additional information.
5. Equipment that may produce aerosols is used within primary containment devices that exhaust air through HEPA filtration before being discharged into the animal room or facility exhaust system. These HEPA filters are tested annually and replaced as needed.
6. All procedures are conducted by personnel wearing a one-piece, positive-pressure supplied-air suit.
 - a. All persons don animal facility clothing, such as scrubs, before entering the room used for donning positive-pressure suits.
 - b. Procedures are in place to control and verify the operation of the one-piece positive-pressure supplied-air suit, including gloves, before each use.
 - c. Decontamination of outer suit gloves is performed during the course of normal operations to remove gross contamination and minimize further contamination of the animal room.
 - d. Inner disposable gloves are worn to protect the laboratorian should a break or tear in the outer suit gloves occur. Disposable inner gloves are not worn outside the inner change area.

- e. Upon exit from the chemical shower, inner gloves and all animal facility clothing are removed and discarded or collected for autoclaving before laundering prior to entering the personal shower.
- f. Prescription eyeglasses are decontaminated before removal through the personal body shower.

D. Animal Facilities (Secondary Barriers)

Cabinet Facility

1. The ABSL-4 cabinet facility consists of either a separate building or a clearly demarcated and isolated zone within a building. Consider placing animal areas away from exterior walls of buildings to minimize the impact from the outside environment temperatures.
 - a. Facility access is restricted. Facility doors are lockable.
 - b. Exit from the animal facility is by sequential passage through an inner (i.e., dirty) changing area, a personal shower, and an outer (i.e., clean) change room upon exiting the cabinet facility.
2. An automatically activated emergency power source is provided at a minimum for the animal facility exhaust system, alarms, lighting, entry and exit controls, BSCs, and door gaskets.
 - a. Monitoring and control systems for air supply, exhaust, life support, alarms, entry and exit controls, and security systems are on an uninterrupted power supply (UPS).
 - b. The emergency power system(s) is tested at least annually.
3. A double-door autoclave, dunk tank, fumigation chamber, or ventilated airlock is provided at the containment barrier for the passage of materials, supplies, or equipment.
4. A hands-free sink is provided near the door from the cabinet room to the inner change rooms. A sink is provided in the outer change room.
5. An eyewash station is readily available in the animal area.
6. Walls, floors, and ceilings of the cabinet facility are constructed to form a sealed internal shell to facilitate fumigation and prohibit animal and insect intrusion. The internal surfaces of this shell are resistant to liquids and chemicals used for cleaning and decontamination of the area. Floors are monolithic, sealed, and coved.
 - a. All penetrations in the internal shell of the facility are sealed.
 - b. Openings around doors into the facility are minimized and capable of being sealed to facilitate decontamination.

7. Services and plumbing that penetrate the facility walls, floors, or ceiling are installed to ensure that no backflow from the facility occurs. These penetrations are fitted with two (in series) backflow prevention devices. Consideration is given to locating these devices outside of containment. Atmospheric venting systems are provided with two HEPA filters in series and are sealed up to the second filter.
8. Furniture is minimized, of simple construction, and capable of supporting anticipated loads and uses.
 - a. Spaces between benches, cabinets, and equipment are accessible for cleaning and decontamination.
 - b. Benchtops are impervious to water and resistant to heat, organic solvents, acids, alkalis, and other chemicals.
 - c. Chairs used in animal areas are covered with a non-porous material that can be easily cleaned and decontaminated as appropriate and sealed to prevent harboring of insects/vermin.
 - d. Equipment and furnishings are carefully evaluated to minimize exposure of personnel to pinch points and sharp edges and corners.
9. Illumination is adequate for all activities and avoids reflections and glare that could impede vision.
10. Windows are break-resistant and sealed.
11. If Class II BSCs or other primary containment barrier systems are needed in the cabinet laboratory, they are installed and operated in a manner to ensure their effectiveness. See [Appendix A](#).
 - a. BSCs are installed so that fluctuations of the room air supply and exhaust do not interfere with proper operations. BSCs are located away from doors, windows that can be opened, heavily traveled areas, and other possible airflow disruptions.
 - b. BSCs can be connected to the animal facility exhaust system by either a canopy connection (Class IIA only) or directly exhausted to the outside through a hard connection (Class IIB, IIC, or III). Cabinet exhaust air passes through two HEPA filters, including the HEPA in the BSC, prior to release outside. Class IIA or IIC BSC exhaust can be safely recirculated back into the animal facility environment if no volatile toxic chemicals are used in the cabinet.
 - c. BSCs are certified at least annually to ensure correct performance, or as specified in [Appendix A, Part 7](#).

12. Central vacuum systems are discouraged. If there is a central vacuum system, it does not serve areas outside the cabinet. Two in-line HEPA filters are placed near each use point and overflow collection is provided while in use. Filters are installed to permit in-place decontamination and replacement.
13. A dedicated, non-recirculating ventilation system is provided. Only facilities with the same HVAC requirements (i.e., other BSL-4 laboratories, ABSL-4, ABSL-3Ag, ABSL-4Ag facilities) may share ventilation systems if gas-tight dampers and HEPA filters isolate each individual room system.
 - a. The supply and exhaust components of the ventilation system are designed to maintain the cabinet facility at negative pressure to surrounding areas and provide differential pressure or directional airflow, as appropriate, between adjacent areas within the facility.
 - b. Redundant supply fans are recommended. Redundant exhaust fans are required. Supply and exhaust fans are interlocked to prevent positive pressurization of the facility.
 - c. The ventilation system is monitored and alarmed to indicate malfunction or deviation from design parameters. A visual monitoring device is installed outside of containment so proper differential pressures within the facility may be verified prior to entry and during regular checklist procedures. Visual monitoring is also in place within the cabinet room.
 - d. Supply air to and exhaust air from the cabinet room, inner change room, and fumigation/decontamination chambers pass through a HEPA filter. The air exhaust discharge is located away from occupied spaces and building air intakes.
 - e. All HEPA filters are located as near as practicable to the cabinet room to minimize the length of potentially contaminated ductwork. All HEPA filters are tested and certified annually.
 - f. The HEPA filter housings are designed to allow for in situ decontamination of the filter and verification of the validated decontamination process prior to removal. The design of the HEPA filter housing has gas-tight isolation dampers, decontamination ports, and the ability to individually scan each filter in the assembly for leaks.
14. Pass-through dunk tanks, fumigation chambers, or equivalent decontamination methods are provided so that materials and equipment that cannot be decontaminated in the autoclave can be safely removed from the cabinet room(s). Access to the exit side of the pass-through is limited

- to those with authorized access to the animal facility and with specific clearance, if required.
15. Liquid effluents from cabinet room sinks, floor drains, autoclave chambers, and other sources within the cabinet facility are decontaminated by a proven method, preferably heat treatment, before being discharged to the sanitary sewer.
 - a. Decontamination of all liquid effluents is documented. The decontamination process for liquid effluents is validated physically and biologically. Biological validation is performed annually or more often as required by institutional policy.
 - b. Effluents from personal body showers and toilets may be discharged to the sanitary sewer without treatment.
 16. A double-door, pass-through autoclave is provided for decontaminating materials passing out of the cabinet facility. Autoclaves that open outside of the facility are sealed to the wall through which the autoclave passes. This bioseal is durable, airtight, and capable of expansion and contraction. Positioning the bioseal so that the equipment can be accessed and maintained from outside the facility is strongly recommended. The autoclave doors are interlocked so that only one can be opened at any time and are automatically controlled so that the outside door to the autoclave can only be opened after the decontamination cycle has been completed.
 - a. Gas discharge from the autoclave chamber is HEPA-filtered or decontaminated. Autoclave decontamination processes are designed so that unfiltered air or steam exposed to infectious material cannot be released to the environment.
 - b. The size of the autoclave is sufficient to accommodate the expected volume of waste, size of equipment and cages, and any future programmatic needs.
 17. Cages are decontaminated prior to removal from the cabinet. The cage wash area is designed to accommodate the use of high-pressure spray systems, humidity, strong chemical disinfectants, and 180°F water temperatures during the cage/equipment cleaning process.
 18. The animal facility design parameters and operational procedures are documented. The facility is tested to verify that the design and operational parameters have been met prior to operation. Facilities are also re-tested annually or after significant modification to ensure operational parameters are maintained. Verification criteria are modified, as necessary, by operational experience.

19. Appropriate communication systems are provided between the animal facility and the outside (e.g., voice, fax, video, and computer). Provisions for emergency communication and emergency access or egress are developed and implemented.

Suit Facility

1. The ABSL-4 suit facility may be located in a separate building or a clearly demarcated and isolated zone within a building. Consider placing animal areas away from exterior walls of buildings to minimize the impact from the outside environment temperatures.
 - a. Facility access is restricted. Facility doors are lockable.
 - b. Entry into the animal facility is through an airlock fitted with airtight doors.
 - c. Exit from the facility is by sequential passage through the chemical shower, inner (i.e., dirty) change room, personal shower, and outer (i.e., clean) changing area.
2. Personnel who enter this area wear a positive-pressure suit supplied with HEPA-filtered breathing air. The breathing air systems have redundant compressors, failure alarms, and emergency back-up capable of supporting all workers within the facility to allow the personnel to safely exit the facility.
3. A chemical shower is provided to decontaminate the surface of the positive-pressure suit before the worker leaves the facility. In the event of an emergency exit or failure of the chemical shower system, a method for decontaminating positive-pressure suits, such as a gravity-fed supply of chemical disinfectant, is provided.
4. An automatically activated emergency power source is provided at a minimum for the animal facility exhaust system, alarms, lighting, entry and exit controls, BSCs, and door gaskets.
 - a. Monitoring and control systems for air supply, exhaust, life support, alarms, entry and exit controls, and security systems are on an uninterrupted power supply (UPS).
5. A double-door autoclave, dunk tank, or fumigation chamber is provided at the containment barrier for the passage of materials, supplies, or equipment in or out of the facility.
6. Hands-free sinks inside the animal facility are placed near procedure areas.

7. An eyewash station for use during maintenance is readily available in the animal area.
8. Walls, floors, and ceilings of the animal facility are constructed to form a sealed internal shell to facilitate fumigation and prohibit animal and insect intrusion. The internal surfaces of this shell are resistant to liquids and chemicals used for cleaning and decontamination of the area. Floors are monolithic, sealed, and coved.
 - a. All penetrations in the internal shell of the animal room(s), suit storage room, and the inner change room are sealed.
9. Services and plumbing that penetrate the facility walls, floors, or ceiling are installed to ensure that no backflow from the facility occurs. Breathing air systems are exempt from this provision. These penetrations are fitted with two (in series) backflow prevention devices. Consideration is given to locating these devices outside of containment. Atmospheric venting systems are provided with two HEPA filters in series, are sealed up to the second filter, and have protection against insect and animal intrusion.
10. Decontamination of the entire facility is performed using a validated gaseous or vapor method when there has been a significant change in facility usage, before major renovations or maintenance shutdowns, and in other situations, as determined by risk assessment. Decontamination is verified prior to any change in the status of the facility.
11. Furniture is minimized, of simple construction, and capable of supporting anticipated loads and uses.
 - a. Spaces between benches, cabinets, and equipment are accessible for cleaning, decontamination and unencumbered movement of personnel.
 - b. Benchtops are impervious to water and resistant to heat, organic solvents, acids, alkalis, and other chemicals.
 - c. Chairs used in animal areas are covered with a non-porous material that can be easily cleaned and decontaminated as appropriate and sealed to prevent harboring of insects/vermin.
 - d. Equipment and furnishings are carefully evaluated to minimize exposure of personnel to pinch points and sharp edges and corners.
12. Windows are break-resistant and sealed.
13. Illumination is adequate for all activities and avoids reflections and glare that could impede vision.

14. BSCs and other primary containment barrier systems are installed in a manner to ensure their effectiveness. See [Appendix A](#).
 - a. BSCs are installed so that fluctuations of the room air supply and exhaust do not interfere with proper operations. BSCs are located away from doors, heavily traveled areas, and other possible airflow disruptions.
 - b. BSCs can be connected to the animal facility exhaust system by either a canopy connection (Class IIA only) or directly exhausted to the outside through a hard connection (Class IIB, IIC, or III), which contains a HEPA filter. Class IIA or IIC BSC exhaust can be safely recirculated back into the facility environment if no volatile toxic chemicals are used in the cabinet.
 - c. BSCs are certified at least annually to ensure correct performance, or as specified in [Appendix A, Part 7](#).
 - d. Class III BSCs are provided supply air in such a manner that prevents positive pressurization of the cabinet or the animal room.
15. Central vacuum systems are discouraged. If there is a central vacuum system, it does not serve areas outside the ABSL-4 facility. Two in-line HEPA filters are placed near each use point and overflow collection is provided while in use. Filters are installed to permit in-place decontamination and replacement. Consideration is made to the provision of two HEPA filters in series as close to the vacuum pump as possible.
16. A dedicated, non-recirculating ventilation system is provided. Only laboratories or facilities with the same HVAC requirements (i.e., other BSL-4 laboratories, ABSL-4, ABSL-3Ag, ABSL-4Ag facilities) may share ventilation systems if gas-tight dampers and HEPA filters isolate each individual animal room.
 - a. The supply and exhaust components of the ventilation system are designed to maintain the ABSL-4 facility at negative pressure to surrounding areas and provide differential pressure or directional airflow as appropriate between adjacent areas within the facility.
 - b. Redundant supply fans are recommended. Redundant exhaust fans are required. Supply and exhaust fans are interlocked to prevent positive pressurization of the facility.
 - c. The ventilation system is monitored and alarmed to indicate malfunction or deviation from design parameters. A visual monitoring device is installed outside of containment so proper differential pressures within the facility may be verified prior to entry and during

- regular checklist procedures. Visual monitoring is also in place within containment.
- d. Supply air to the animal facility, including the decontamination shower, passes through a HEPA filter. All exhaust air from the suit facility, decontamination shower, and fumigation or decontamination chambers passes through two HEPA filters, in series, before discharge to the outside. The exhaust air discharge is located away from occupied spaces and air intakes.
 - e. All HEPA filters are located as near as practicable to the areas where infectious materials and/or animals are housed or manipulated to minimize the length of potentially contaminated ductwork. All HEPA filters are tested and certified annually.
 - f. The HEPA filter housings are designed to allow for in situ decontamination of the filter and verification of the validated decontamination process prior to removal. The design of the HEPA filter housing has gas-tight isolation dampers, decontamination ports, and the ability to individually scan each filter in the assembly for leaks.
17. Pass-through dunk tanks, fumigation chambers, or equivalent decontamination methods are provided so that materials and equipment that cannot be decontaminated in the autoclave can be safely removed from the animal facility. Access to the exit side of the pass-through is limited to those individuals authorized to be in the animal facility and provided with appropriate clearance if required.
 18. Liquid effluents from chemical showers, sinks, floor drains, autoclave chambers, and other sources within the facility are decontaminated by a proven method, preferably heat treatment, before being discharged to the sanitary sewer.
 - a. Decontamination of all liquid effluents is documented. The decontamination process for liquid effluents is validated physically and biologically. Biological validation is performed at least annually or more often as required by institutional policy.
 - b. Effluents from personal body showers and toilets may be discharged to the sanitary sewer without treatment.
 19. A double-door, pass-through autoclave(s) is provided for decontaminating materials passing out of the facility. Autoclaves that open outside of the facility are sealed to the wall through which the autoclave passes. This bioseal is durable, airtight, and capable of expansion and contraction. Positioning the bioseal so that the equipment can be accessed and maintained from outside the facility is strongly

recommended. The autoclave doors are interlocked so that only one can be opened at any time and be automatically controlled so that the outside door to the autoclave can only be opened after the decontamination cycle has been completed.

- a. Gas discharge from the autoclave chamber is HEPA-filtered or is decontaminated. Autoclave decontamination processes are designed so that unfiltered air or steam exposed to infectious material cannot be released to the environment.
 - b. The size of the autoclave is sufficient to accommodate the expected volume of waste, size of equipment and cages, and any future programmatic needs.
20. Cages are decontaminated prior to removal from the animal facility. The cage wash area is designed to accommodate the use of high-pressure spray systems, humidity, strong chemical disinfectants, and 180°F water temperatures during the cage/equipment cleaning process.
21. The ABSL-4 facility design parameters and operational procedures are documented. The facility is tested to verify that the design and operational parameters have been met prior to operation. Facilities are also re-tested annually or after significant modification to ensure operational parameters are maintained. Verification criteria are modified, as necessary, by operational experience.
22. Appropriate communication systems are provided between the facility and the outside (e.g., voice, fax, video, and computer). Provisions for emergency communication and emergency access or egress are developed and implemented.
23. Facilities housing animals in open caging have the following design elements:
- a. Access to the animal holding room from service corridors outside of the containment space requires passage through two sets of doors, and the innermost door is an air pressure resistant (APR) door.
 - b. For any animal holding room considered to be a primary barrier, the APR door(s) providing direct ingress from the exterior service corridor is fitted with appropriate and redundant lockout mechanisms to prevent access when the animal-holding room is contaminated and in use. There is more than one mechanism to ensure that this primary barrier door cannot be opened when the animal room is contaminated and the APR door does not serve as an emergency exit from the animal facility. The APR door is appropriately tested to

demonstrate that in the closed, locked-out mode, the door provides an air-tight barrier proven by pressure decay testing or other equivalent method(s).

- c. Any door(s) allowing access into an internal corridor from which there is direct ingress to an animal holding room is fitted with either: 1) an APR door; or 2) a non-APR door, providing directional airflow is maintained from the corridor space into the animal room. For the purpose of fumigation, animal rooms equipped with non-APR doors opening into the adjacent interior corridors are considered one space (i.e., areas between air-tight doors are fumigated together).
 - d. Any door(s) used for access to the out-of-containment service corridor (the secondary barrier) are self-closing and of solid construction, designed not to corrode, split, or warp.
 - e. Access to the service corridor inside the secondary barrier is restricted and strictly controlled when animal rooms are in use. Whenever possible, the secondary barrier door(s) is fitted with safety interlock switches designed to prevent it from opening when an animal-holding room door (the primary barrier) is opened following room decontamination; if interlock devices cannot be used, specific administrative procedures are implemented to control access to the service corridor.
 - f. The out-of-containment service corridor maintains a negative pressure (inward directional airflow) relative to adjoining traffic corridors.
24. Loose-housed or open penned animals may be subject to the requirements of ABSL-3Ag or ABSL-4Ag. See [Appendix D](#) for additional information.

References

1. USDA [Internet]. Washington (DC): Office of the Chief Information Officer; c2002 [cited 2019 April 30]. USDA Security Policies and Procedures for Biosafety Level 3 Facilities. Available from: <https://www.ocio.usda.gov/document/departmental-manual-9610-001>
2. National Institutes of Health, Office of Laboratory Animal Welfare. Public Health Service policy on humane care and use of laboratory animals. Bethesda (MD): U.S. Department of Health and Human Services; 2015.
3. Institute for Laboratory Animal Research. Guide for the Care and Use of Laboratory Animals. 8th ed. Washington (DC): The National Academy Press; 2011.

4. Animal Welfare Act and Amendment, 9 C.F.R. Subchapter A, Parts 1, 2, 3 (1976).
5. Tabak LA. Appendix G-II-D-2-1. Containment for Animal Research. Fed Regist. 2016;81(73):22287.
6. National Research Council. Occupational Health and Safety in the Care and Use of Research Animals. Washington (DC): National Academy Press; 1997.
7. National Research Council; Institute for Laboratory Animal Research. Occupational health and safety in the care and use of nonhuman primates. Washington (DC): The National Academy Press; 2003.
8. Grammer LC, Greenberger PA. Patterson's Allergic Diseases. Baltimore (MD). Lippincott Williams & Wilkins; 2009.
9. Hunt LW, Fransway AF, Reed CE, Miller LK, Jones RT, Swanson MC, et al. An epidemic of occupational allergy to latex involving health care workers. J Occup Environ Med. 1995;37(10):1204–9.
10. Centers for Disease Control and Prevention [Internet]. Atlanta (GA): The National Institute for Occupational Safety and Health; c1997 [cited 2019 April 30]. Preventing Allergic Reactions to Natural Rubber Latex in the Workplace. Available from: <https://www.cdc.gov/niosh/docs/97-135/default.html>
11. United States Department of Labor [Internet]. Washington (DC): Occupational Safety and Health Administration; c2008 [cited 2019 April 30]. Potential for Sensitization and Possible Allergic Reaction to Natural Rubber Latex Gloves and other Natural Rubber Products. DHHS (NIOSH) Publication Number 97-135. Available from: <https://www.osha.gov/dts/shib/shib012808.html>
12. Allmers H, Brehler R, Chen Z, Raulf-Heimsoth M, Fels H, Baur X. Reduction of latex aeroallergens and latex-specific IgE antibodies in sensitized workers after removal of powdered natural rubber latex gloves in a hospital. J Allergy Clin Immunol. 1998;102(5):841–6.
13. Bloodborne pathogens, 29 C.F.R. Part 1910.1030 (1992).

Section VI—Principles of Laboratory Biosecurity

The anthrax attacks on U.S. citizens in October 2001 and the subsequent expansion of the United States Select Agent regulations in December 2003 have led scientists, laboratory managers, security specialists, biosafety professionals, and other scientific and institutional leaders to consider the need for developing, implementing, and/or improving the security of biological agents and toxins within their facilities.¹ Since the publication of the fifth edition of BMBL, laboratory biosecurity was better defined by biorisk management documents including the International Standard Organization (ISO) 35001, Biorisk Management for Laboratories and Other Related Organizations. Other efforts include pre-access suitability, personnel reliability, and threat management approaches that identify and manage behavioral problems that could result in laboratory biosecurity risks.

This section describes laboratory biosecurity planning for microbiological and biomedical laboratories. As indicated below, laboratories with good biosafety programs already fulfill many of the basic requirements needed to secure biological materials. For laboratories not handling Select Agents, the access controls and training requirements specified for BSL-2 and BSL-3 in [Section IV](#) of BMBL may provide sufficient security for the materials being studied. Security assessments and additional security measures should be considered when Select Agents, other agents of high public health, environmental, and agriculture concerns, or agents of high economic/commercial value such as patented vaccine candidates are introduced into the laboratory.

The recommendations presented in this section are advisory. Excluding the Select Agent regulations, Executive Order (EO) 13546, and the Global Health Security Agenda EO 13747 (GHSA), there is no current federal requirement for the development of a laboratory biosecurity program. However, the application of these principles and the assessment process may enhance overall laboratory management, safety, and security. Laboratories that fall under the Select Agent regulations should consult [Appendix F](#).²⁻⁴

The term biosecurity has multiple definitions. In the plant and animal industry, agricultural biosecurity relates to policies, measures, and regulatory frameworks, based in science, applied to protect, manage, and respond to risks associated with food, agriculture, health, and the environment. In some countries, biosecurity is used in place of the term biosafety. For the purposes of this section, the term *laboratory biosecurity*⁵ will refer to measures designed to prevent loss, theft, or deliberate misuse of biological material, technology, or research-related information from laboratories or laboratory-associated facilities. See [Appendix D](#) for additional information about agricultural biosecurity.

Security is not a new concept in laboratories handling biological agents and materials. Several of the security measures discussed in this section are

embedded in the Biosafety Levels that serve as the foundation for good laboratory practices throughout the biological laboratory community. Most biomedical and microbiological laboratories do not have Select Agents or Toxins; however, they maintain control over and account for research materials, protect relevant sensitive information, and work in facilities with access controls commensurate with the potential public health, agricultural, environmental, and economic impact of the biological agents in their collections. These measures are in place in most laboratories that apply good laboratory management practices and have appropriate biosafety programs.

Biosafety and Laboratory Biosecurity

Biosafety and laboratory biosecurity are related concepts, but they are not identical. Biosafety programs reduce exposure of individuals and the environment to potentially hazardous biological agents. Biosafety is achieved by implementing various degrees of performance-based control and containment measures for biological materials, through infrastructure design and access restrictions, personnel expertise and training, use of containment equipment, and safe methods of managing infectious materials.

Laboratory biosecurity, the prevention of the theft, loss, or misuse of biological material, technology, or research-related information, is accomplished through personnel vetting, personnel reliability, violence prevention programs, laboratory biosecurity training, dual-use research oversight process, cybersecurity standards, material and facility control, and accountability standards; however, laboratory biosecurity is not limited to this list.

While the objectives are different, biosafety and laboratory biosecurity measures are usually complementary and share common components. Both are based upon risk assessment and management methodology; personnel expertise and responsibility; control and accountability for research materials including microorganisms and culture stocks; access control elements; material transfer documentation; training; emergency planning; and program management.

Both programs assess personnel qualifications. The biosafety program ensures that personnel are qualified to perform their jobs safely through training and documentation of technical expertise. Staff must exhibit the appropriate level of professional responsibility for the management of research materials by adherence to appropriate materials management procedures. Biosafety practices require laboratory access to be limited when work is in progress. Laboratory biosecurity practices ensure that access to the laboratory facility and biological materials are limited and controlled as necessary. Facilities should have pre-established reporting mechanisms regarding any concerning behavior/incidents in order to alleviate laboratory biosecurity insider threat concerns. An inventory or material management process for control and tracking of biological stocks or

other sensitive materials is also a component of both programs. For biosafety, the shipment of infectious biological materials must adhere to safe packaging, containment, and appropriate transport procedures; laboratory biosecurity ensures that transfers are controlled, tracked, and documented commensurate with the potential risks. Both programs must engage laboratory personnel in the development of practices and procedures that fulfill the biosafety and laboratory biosecurity program objectives but that do not hinder research or clinical/ diagnostic activities. The success of both programs hinges on a laboratory culture that understands and accepts the rationale for biosafety and laboratory biosecurity programs and the corresponding management oversight.

In some cases, laboratory biosecurity practices may conflict with biosafety practices, requiring personnel and management to devise policies that accommodate both sets of objectives (e.g. signage). Standard biosafety practice requires that signage be posted on laboratory doors to alert people to the hazards that may be present within the laboratory. The biohazard sign normally includes the name of the agent, specific hazards, and precautions (e.g., PPE) associated with the use or handling of the agent and contact information for the investigator. These hazard communication practices may conflict with security objectives. Therefore, biosafety and laboratory biosecurity considerations must be balanced and proportional to the identified risks when developing institutional policies. Alternative solutions may be developed and implemented to meet both sets of objectives.

Designing a laboratory biosecurity program that does not jeopardize laboratory operations or interfere with the conduct of research requires a familiarity with microbiology and the materials that require protection. Protecting pathogens and other sensitive biological materials while preserving the free exchange of research materials and information may present significant institutional challenges. Therefore, a combination or tiered approach to protecting biological materials, commensurate with the identified risks, often provides the best resolution to conflicts that may arise. However, in the absence of legal requirements for a laboratory biosecurity program, the health and safety of laboratory personnel, and the surrounding environment should take precedence over laboratory biosecurity concerns.

A risk management methodology can be used to identify the need for a laboratory biosecurity program. A risk management approach to laboratory biosecurity:

1. Establishes which, if any, agents, technology, and/or research-related information require laboratory biosecurity measures to prevent loss, theft, diversion, or intentional misuse; and
2. Ensures that the protective measures provided, and the costs associated with that protection, are proportional to the risk.

The need for a laboratory biosecurity program should be based on the possible impact of the theft, loss, diversion, or intentional misuse of the materials, recognizing that different agents and toxins will pose different levels of risk. Resources are not infinite. Laboratory biosecurity policies and procedures should not seek to protect against every conceivable risk. The risks need to be identified and prioritized, and resources need to be allocated based on that prioritization. Not all institutions will rank the same agent at the same risk level. Risk management methodology takes into consideration available institutional resources and the risk tolerance of the institution.

Developing a Laboratory Biosecurity Program

Management, researchers and laboratory supervisors must be committed to being responsible stewards of infectious agents and toxins. Development and implementation of a laboratory biosecurity program should be a collaborative process involving all stakeholders. The stakeholders include, but are not limited to: senior management; scientific staff; human resource officials; information technology staff; and safety, security, and engineering personnel. The involvement of organizations and/or personnel responsible for a facility's overall security is critical because many potential laboratory biosecurity measures may already be in place as part of an existing safety or security program. This coordinated approach is essential in ensuring that the laboratory biosecurity program provides reasonable, timely, and cost-effective solutions addressing the identified security risks without unduly affecting the scientific or business enterprise or the provision of clinical and/or diagnostic services.

There is a need to include law enforcement and security communities in the development of preventive measures and enforcement principles going beyond response and consequence management, especially for laboratories working at BSL-3 or BSL-4. The FBI has a Weapons of Mass Destruction (WMD) Coordinator assigned to each of its field offices across the U.S. WMD Coordinators are responsible for conducting laboratory biosecurity outreach in their area of responsibility and being a point of contact for any concerns/threats involving WMD, including biological agents and materials.

The need for a laboratory biosecurity program should reflect sound risk management practices based on a site-specific risk assessment. A laboratory biosecurity risk assessment should analyze the probability and consequences of loss, theft, and potential misuse of biological material, technology, or research-related information.⁶ Most importantly, the laboratory biosecurity risk assessment should be used as the basis for making risk management decisions that are balanced with the needs of the biosafety risk assessment.

Example Guidance: A Laboratory Biosecurity Risk Assessment and Management Process

Different models exist regarding laboratory biosecurity risk assessment. Most models share common components such as asset identification, threat, vulnerability, and mitigation. What follows is one example of how a laboratory biosecurity risk assessment may be conducted. In this example, the entire risk assessment and risk management process may be divided into five main steps, each of which can be further subdivided. Example guidance for these five steps is provided below.

Step 1: Identify and Prioritize Biological Materials, Research-Related Information, and Technology

- Identify the biological materials, research-related information, and technology that exist at the institution.
- Identify the form of the material, location, and quantities, including non-replicating materials (e.g., toxins).
- Evaluate the potential for misuse of these assets.
- Evaluate the consequences of misuse of these assets.

Prioritize the assets based on the consequences of misuse (i.e., risk of malicious use). At this point, an institution may find that none of its biologic materials, research-related information, or technology merit the development and implementation of a separate laboratory biosecurity program or that the existing security at the facility is adequate. In this event, no additional steps would need to be completed.

Step 2: Identify and Prioritize the Threat to Biological Materials, Research-Related Information, and Technology

- Identify the types of “Insiders” who may pose a threat to the biologic materials, research-related information, and technology at the institution.
- Identify the types of “Outsiders” (if any) who may pose a threat to the biologic materials, research-related information, and technology at the institution.
- Evaluate and prioritize the motive, means, and opportunity of these various potential adversaries.

Step 3: Analyze the Risk of Specific Security Scenarios

- Develop a list of possible laboratory biosecurity scenarios or undesired events that could occur at the institution. Each scenario is a combination of an item, an adversary, and an action. Consider:
 - Access to the item within the laboratory;
 - How the undesired event could occur;
 - Protective measures in place to prevent occurrence; and

- How the existing protection measures could be breached (i.e., vulnerabilities).
- Evaluate the probability of each scenario materializing (i.e., the likelihood) and its associated consequences. Assumptions include:
 - Although a wide range of threats are possible, certain threats are more probable than others; and
 - All agents/assets are not equally attractive to an adversary; valid and credible threats, existing precautions, and the potential need for select enhanced precautions are considered.
- Prioritize or rank the scenarios by risk for review by management.

Step 4: Develop an Overall Risk Management Program

- Management commits to oversight, implementation, training, and maintenance of the laboratory biosecurity program.
- Management develops a laboratory biosecurity risk statement, documenting which laboratory biosecurity scenarios represent an unacceptable risk and must be mitigated vs. those risks appropriately handled through existing protection control.
- Management develops a laboratory biosecurity plan to describe how the institution will mitigate those unacceptable risks including:
 - A written security plan, standard operating procedures, and incident response plans; and
 - Written protocols for employee training on potential hazards, the laboratory biosecurity program, and incident response plans.
- Management ensures necessary resources to achieve the protection measures documented in the laboratory biosecurity plan.

Step 5: Re-evaluate the Institution's Risk Posture and Protection Objectives

- Management regularly reevaluates and makes necessary modifications to the:
 - Laboratory biosecurity risk statement;
 - Laboratory biosecurity risk assessment process;
 - Institution's laboratory biosecurity program/plan; and
 - Institution's laboratory biosecurity systems.
- Management assures the daily implementation, training, annual re-evaluation and practice drills of the security program.

Elements of a Laboratory Biosecurity Program

Many facilities may determine that existing safety and security programs provide adequate mitigation for the security concerns identified through the laboratory biosecurity risk assessment. This section offers examples and suggestions for components of a laboratory biosecurity program should the risk assessment reveal that further protections may be warranted. Program components should be site-specific and based upon organizational threat/vulnerability assessment and

as determined appropriate by facility management. Elements discussed below should be implemented, as needed, based upon the risk assessment process. They should not be construed as minimum requirements or minimum standards for a laboratory biosecurity program.

Program Management

If a laboratory biosecurity plan is implemented, institutional management must support the laboratory biosecurity program. Appropriate authority must be delegated for implementation and the necessary resources provided to assure program goals are being met. An organizational structure for the laboratory biosecurity program that clearly defines the chain of command, roles, and responsibilities should be distributed to the staff. Program management should ensure that laboratory biosecurity plans are created, implemented, exercised, and revised as needed. The laboratory biosecurity program should be integrated into relevant institutional policies and plans.

Physical Security—Access Control and Monitoring

The physical security elements of a laboratory biosecurity program are intended to prevent the introduction and removal of assets for non-official purposes. An evaluation of the physical security measures should include a thorough review of the building(s) and premises, the laboratories, and the biological material storage areas. Many requirements for a laboratory biosecurity plan may already exist in a facility's overall security plan.

Access should be limited to authorized and designated employees based on the need to enter sensitive areas. Methods for limiting access could be as simple as locking doors or having a card key system in place. Evaluations of the levels of access should consider all facets of the laboratory's operations and programs (e.g., laboratory entrance requirements, freezer access). The need for entry by visitors, laboratory workers, management officials, students, cleaning and maintenance staff, and emergency response personnel should be considered.

Personnel Management

Personnel management includes identifying the roles and responsibilities for employees who handle, use, store, and transport pathogens and/or other important assets. The effectiveness of a laboratory biosecurity program against identified threats depends, first and foremost, on the integrity and awareness of those individuals who have access to pathogens, toxins, sensitive information and/or other assets. Employee vetting/screening policies and procedures are used to help evaluate these individuals. To maintain a personnel reliability and violence prevention plan, management should conduct periodic reviews of staff, establish an anonymous peer and threat reporting system, institute an Employee Health and Wellness Program, and foster leadership accountability to address submitted reports. Policies should also be developed for personnel and visitor

identification, visitor management, access procedures, and reporting of security incidents.

Inventory and Accountability

Material accountability procedures should be established to track the inventory of biological materials and toxins; storage including physical and digital; the use, transfer, and destruction of dangerous biological materials and assets when no longer needed; and the inactivation of biological materials, particularly prior to transport outside the facility. See [Appendix K](#). The objective is to know what assets exist at a facility, where they are located, and who is responsible for them. To achieve this, management should define:

1. The materials (or forms of materials) subject to accountability measures;
2. Records to be maintained and timelines for record retention;
3. Operating procedures associated with inventory maintenance (e.g., how material is identified, where it can be used and stored); and
4. Documentation and reporting requirements.

It is important to emphasize that microbiological agents are capable of replication and are often propagated. Therefore, knowing the exact quantity of organisms at any given time may be impractical. Depending on the risks associated with a pathogen or toxin, management can designate an individual who is accountable, knowledgeable about the materials in use, and responsible for the security of the materials under his or her control.

Information Security

Policies should be established for handling sensitive information associated with the laboratory biosecurity program. For the purpose of these policies, “sensitive information” is information that is related to the security of pathogens and toxins or other critical infrastructure information. Examples of sensitive information may include facility security plans, access control codes, newly developed technologies or methodologies, agent inventories, and storage locations.

Discussion of information security in this section does not pertain to information that has been designated “classified” by the United States pursuant to Executive Order 12958, as amended, and is governed by United States law or to research-related information that is typically unregulated or unrestricted through the peer-review and approval processes.

The objectives of an information security program are to ensure data integrity, protect information from unauthorized release, and ensure that the appropriate level of confidentiality is preserved. Facilities should develop policies that govern the proper identification, marking, handling, securing, and storage of sensitive information including electronic files and removable electronic media (e.g., CDs,

external hard drives, USB flash drives). The information security program should be tailored to meet the needs of the business environment, support the mission of the organization, and mitigate the identified threats. It is critical that access to sensitive information be controlled.

Transport of Biological Agents

Material transport policies should include accountability measures for the movement of materials within an institution (e.g., between laboratories, during shipping and receiving activities) and outside of the facility (e.g., between institutions or locations). Transport policies should address the need for appropriate documentation and material accountability and control procedures for biological materials and toxins in transit between locations. Transport security measures should be instituted to ensure that appropriate authorizations have been received and that adequate communication between facilities has occurred before, during, and after transport of pathogens or other potentially hazardous biological materials. Personnel should be adequately trained and familiar with regulatory and institutional procedures for proper containment, packaging, labeling, documentation, and transport of biological materials.

Accident, Injury, and Incident Response Plans

Laboratory security policies should consider situations that may require emergency responders or public safety personnel to enter the facility in response to an accident, injury, or other safety issue or security threat. The preservation of human life and the safety and health of laboratory employees and the surrounding community must take precedence over laboratory biosecurity and biosafety concerns in an emergency.

Facilities are encouraged to coordinate with medical, fire, police, and other emergency officials when preparing emergency and security breach response plans. Standard Operating Procedures (SOPs) should be developed that minimize the potential exposure of responding personnel to potentially hazardous biological materials. Laboratory emergency response plans should be integrated with relevant facility-wide or site-specific security plans. These plans should also consider such adverse events as bomb threats, natural disasters and severe weather, power outages, and other facility emergencies that may introduce security threats.

Reporting and Communication

Communication is an important aspect of a laboratory biosecurity program. A "chain-of-notification" should be established in advance of an actual event. This communication chain should include laboratory and program officials, institution management, and any relevant regulatory or public authorities. The roles and responsibilities of all involved officials and programs should be clearly defined.

Policies should address the reporting and investigation of potential security breaches (e.g., missing biological agents, unusual or threatening phone calls, unauthorized personnel in restricted areas, unauthorized transfer of assets to and from the facility).

Training and Practice Drills

Laboratory biosecurity training is essential for the successful implementation of a laboratory biosecurity program. Program management should establish training programs that inform and educate individuals regarding their responsibilities within the laboratory and the institution. For example, it might be difficult to identify suspicious activity that warrants attention without appropriate training on security awareness, laboratory biosecurity best practices, and the facility's established reporting mechanisms. Practice drills should address a variety of scenarios such as loss or theft of materials, emergency response to accidents and injuries, incident reporting, and identification of and response to security breaches. These scenarios may be incorporated into existing emergency response drills such as fire drills or building evacuation drills associated with bomb threats. Incorporating laboratory biosecurity measures into existing procedures and response plans often provide efficient use of resources, saves time, and can minimize confusion during emergencies.

Security Updates and Re-evaluations

The laboratory biosecurity risk assessment and program should be reviewed and updated routinely and following any laboratory biosecurity-related incident. Re-evaluation is a necessary and on-going process in the dynamic environments of today's biomedical and research laboratories. Laboratory biosecurity program managers should develop and conduct laboratory biosecurity program audits and implement corrective actions as needed. Audit results and corrective actions should be documented. The appropriate program officials should maintain records.

Select Agents

If a laboratory possesses, uses, or transfers Select Agents, it must comply with all requirements of the National Select Agent Program. See [Appendix F](#) for additional information

References

1. Richmond, JY, Nesby-O'Dell, SL. Laboratory security and emergency response guidance for laboratories working with select agents. MMWR Recomm Rep. 2002;51(RR-19):1–8.
2. Possession, use, and transfer of select agents and toxins; Final Rule, 42 C.F.R. Part 73 (2005).

3. Possession, use, and transfer of biological agents and toxins, 7 C.F.R. Part 331 (2005).
4. Possession, use, and transfer of biological agents and toxins, 9 C.F.R. Part 121 (2005).
5. World Health Organization. Biorisk Management. Laboratory Biosecurity Guidance. Geneva: World Health Organization; 2006.
6. Casadevall A, Pirofski L. The weapon potential of a microbe. *Trends in Microbiology*. 2004;12(6):259–63.

Section VII—Occupational Health Support for Biomedical Research

The occupational health provider is integral in the promotion of a workplace culture of safety in biomedical and microbiological research. An occupational health program that supports staff with access to biological hazards, such as infectious agents or toxins, should aim to alleviate the risk of adverse health consequences due to potential exposures to biohazards in the workplace. Health services should be risk-based and tailored to meet the needs of individual staff and the research institution based on risk assessment. Ideally, the program focuses on work-related healthcare to avoid potential conflicts of interest. An institution must carefully consider available options for implementing robust occupational health support as an essential component of its risk management strategy.^{1,2}

Framework for Occupational Health Support of Biomedical Research

Basic Concepts for Providing Work-Related Healthcare in a Research Setting

Occupational health services that support a biomedical research community should be based on detailed risk assessments of hazards in the workplace.³ See [Section II](#) for additional information. Services should complement the hierarchy of exposure controls and provide relief in case of potential exposure to a hazard.⁴ Medical countermeasures such as vaccines, wound decontamination, or pharmaceutical agents may reduce the risk of harm, but they do not eliminate it (e.g., vaccine failure or antibiotic resistance).^{5,6}

Different elements of occupational health support may be indicated at various stages of employment, ranging from anticipatory risk mitigation (e.g., preplacement evaluation or vaccination) to incident-driven medical measures such as post-exposure immuno- or chemoprophylaxis. A change in a staff member's health status suggestive of a Laboratory-associated infection (LAI) requires clinical care and an interdisciplinary investigation into a possible antecedent occupational exposure. At each juncture, the healthcare provider must take care to tailor services to mitigate the individual staff member's risk for harm.^{1,7}

Before research involving biological hazards begins, stakeholders should have plans in place for providing occupational health support for staff commensurate with the potential health risks of the proposed work (i.e., pathogens, activities, and work environment or facility).⁸ An institution may require, as a condition of employment, its staff to participate in relevant occupational health programs designed to reduce risks associated with research on biological agents that may pose grave threats to human health and society (high-consequence pathogens).⁹ The provider may consider establishing contact with subject matter experts (SMEs) for consultation on procedural and clinical elements of the program, especially agent-specific occupational exposure and illness response plans

concerning high-consequence pathogens or bioengineered infectious particles whose pathogenic potential is not established.^{10,11}

Continual collaboration among stakeholders is key to optimal protection of biomedical research staff. The designated occupational healthcare provider should work with institutional safety staff, principal investigators (PIs), and clinically-oriented SMEs (i.e., infectious diseases specialists) to ensure optimal work-related health care of laboratorians and their support staff.

Practical and Regulatory Requirements for Occupational Health Programs

Occupational health services may be administered through a variety of arrangements and may be employer- or community-based, provided they are readily available, allow timely evaluation, and appropriate treatment. Regardless of employment status, all workers should have access to a comparable level of care and occupational health services based on their risk of occupational hazard exposure. Contractors, students, volunteers, and visitors should receive work-related occupational health services through their employer or sponsor equivalent to those provided by the host institution for its employees.

The designated occupational health provider should be familiar with the nature of hazards in the work environment and the controls used to prevent exposures. The program should have the means to implement promptly any indicated pre- and post-exposure medical measures and related counseling. The provider should ensure that services rendered remain consistent and conform to current practices such as recommended immunization schedules and infection control.^{12–14} Expanded discussions of principles of standard occupational health practices are available in authoritative texts.^{15,16} The provider should be aware of and abide by guidance or regulations including but not limited to the *NIH Guidelines for Research Involving Recombinant or Synthetic Nucleic Acid Molecules* (NIH Guidelines); Title 42 of the Code of Federal Regulations, Part 73; relevant Occupational Safety and Health Administration (OSHA) standards; the Americans with Disabilities Act (ADA) of 1990 and related regulations; the Pregnancy Discrimination Act of 1978; and patient confidentiality laws including Health Insurance Portability and Accountability Act of 1996 (HIPAA).^{17–24}

Risk-based Design of Occupational Health Services

The scope of an occupational health program should match the clinical and research portfolio of the institution it supports. Institutional biosafety and security policies may require additional occupational health support. This publication advises stakeholders in staff members' safety and health in microbiological and biomedical research laboratories on recommendations for working safely with biological agents ranging from Risk Groups (RG) 1 to 4. Please refer to [Sections II, III, and IV](#) for additional information on RG classification and Biosafety Level (BSL) requirements. Work with microbes that are not associated with disease in

healthy adults (RG1) likely requires minimal occupational health support, although the provider should be aware of other non-biological hazards that may be present in the laboratory. Staff with access to RG2, RG3, or RG4 biological agents should be provided with occupational health services that stand to decrease the risk of potential harm. The program will need to commit resources that are likely proportionate to the severity of potential health risks of these agents and the residual risk of exposure after implementation of applicable controls. This consideration becomes especially pronounced for programs that support RG3 and RG4 pathogen research where the elevated cost of emergency preparedness reflects the need to mitigate a wide range of risks, including those associated with high-impact, low-probability events.^{25–27}

With increasingly widespread applications of advances in bioengineering, occupational medical staff must be prepared to adapt established practices to evolving workplace hazards.^{28–30} The principles of expert risk-based occupational health support for work with naturally occurring biological agents apply to work with genetically modified organisms, designer biologics, or novel genetic constructs. For example, viral vectors deployed in gene therapy or vaccinology may be engineered to incorporate safety features at the genomic level to decrease infectivity or virulence. However, even highly genetically altered particles should not be presumed to be risk-free to staff who are exposed to them, as illustrated by the replacement of first-generation lentiviral platforms with third- or fourth-generation HIV-derived vectors.³¹ Until immediate and long-term health risks of genetically modified organisms or synthetic constructs are better characterized (e.g., insertional mutagenesis), the provider must appreciate that an agent's genome-level safety features may not fully protect exposed staff from potential health risks. The NIH Office of Science Policy provides guidance on assessing and mitigating potential harm from recombinant nucleic acids, genetically modified organisms, or entirely new constructs with varying capacity to infect human cells.^{17,32}

Staff may require additional occupational health services besides those targeting biological agents under scientific investigation. For example, researchers engaged in human subjects research activities or animal care and veterinary staff who support the use of laboratory animals should receive all applicable medical care and counseling.³³ Laboratory animals may become zoonotic disease vectors when a staff member is exposed to an infected animal's body fluids or tissues (e.g., Macacine alphaherpesvirus 1 [B virus] or Simian immunodeficiency virus [SIV]).^{34,35} In turn, susceptible research animals must be protected from reverse zoonotic transmission of human pathogens. For example, Measles morbillivirus or *Mycobacterium tuberculosis* (Mtb) may devastate non-human primates (NHPs) and cause substantial losses.³⁶ Other potential hazards may add to the complexity of pertinent occupational health support; some with established risk factors such as human-derived materials; chemical, physical, or environmental hazards; and others with less well-circumscribed risk to staff (e.g., hazards

associated with field research or outbreak response). OSHA provides general guidance on safety and health in a laboratory environment such as respiratory protection and hearing conservation.^{19,37,38} The occupational health program should collaborate with institutional biosafety, management, and subject matter experts to customize services that complement risk mitigation in biomedical research.

Pre- and Post-exposure Communications

All biomedical research laboratories should maintain a laboratory-specific biosafety manual that specifies the steps all staff should take immediately after an incident. An effective incident response, including medical care of affected staff, relies on the coordinated execution of the plan and concise, prompt communications.³⁹ Laying the foundation for proper post-exposure risk mitigation begins before an occupational exposure occurs (e.g., with risk awareness training in the workplace and targeted preplacement occupational health evaluations). Incident response protocols should describe requisite notifications at the time of a potential exposure, including how to access medical care.⁴⁰ All staff should identify and work to remove barriers to prompt, qualified post-exposure medical care. Community-based medical care of a staff member after a potential occupational exposure may require additional steps to ensure optimal assessment and treatment of the staff member, including connecting the healthcare provider with SMEs.

Occupational Health and Risk Management

The designated occupational health program should design a quality assurance program to monitor internal operations and interdisciplinary processes with a healthcare component.⁴¹ Each occupational health support offering and procedure should be reviewed regularly with respect to the most current practice guidelines and relevance to the research supported. The occupational health program is uniquely positioned to contribute to the institution's ongoing risk management activities. For example, prevention of future exposures should be informed by the collection and analysis of work-related injury and illness statistics.^{42,43}

Elements of an Occupational Health Program Supporting Biomedical Research

Preplacement Medical Evaluations

Supervisors should inform all workers about workplace hazards and exposure controls and refer newly hired staff with proposed access to biological hazards (e.g., biological agents, human subjects, laboratory animals, or their respective body fluids or tissues) to the occupational health program for a risk-based preplacement medical evaluation.^{1,19} The healthcare provider must review staff members' personal and occupational health history in light of the supervisors' input on potential hazards and minimum functional requirements of the position. This standard review includes past and current medical conditions and treatment;

present use of medications (prescription and non-prescription); allergies and adverse reactions to medicines, vaccines, animals, and other environmental allergens; and a complete immunization history, including serology results, when appropriate, or relevant prior infections. The provider should discuss agent-specific risk factors and incidental hazards (e.g., zoonotic infections, toxic chemicals, or laboratory animal allergens), and the provider should dispense information on health conditions that might increase susceptibility to infection and complications after an occupational exposure. The provider should ensure staff members' familiarity with the need for standard first aid after an exposure, and the need to promptly report work-related injuries and illnesses. The importance of exposure prevention should be emphasized while cautioning against overreliance on medical countermeasures for curbing work-related health risks. For example, minimizing exposure to likely allergens (e.g., animal proteins or latex) is paramount to the control of occupational allergies. Sensitization to specific allergens may not be reversible even with treatment. Staff should be directed to supervisors and safety professionals for training and proper use of applicable exposure control strategies, including personal protective equipment (PPE).⁸ The provider should also advise staff on steps to take in cases of potentially work-related illness(es), such as signs or symptoms suggestive of an LAI or an occupationally-acquired allergy.

The occupational health program should offer only those services that constitute effective medical support related to workplace hazards and duties. For example, testing for immunity to a specific pathogen is rarely indicated as a condition for employment. Pre-immunization serology should be performed in accordance with established risk-based guidelines.^{13,44} Serum banking, the practice of collecting and storing frozen serum samples, is of questionable value to the care of research or clinical laboratory staff; it should not be offered routinely without a clear indication. An exception may be made if a risk assessment suggests that work conditions are likely to lead to unrecognized exposures, especially to pathogens with long latency periods or with the potential for subclinical infection. If serum banking is utilized, the provider must implement it with the requisite precautions to ensure accurate retrieval, proper storage and disposal, patient privacy, and observance of applicable ethics standards.^{1,45} Serum sampling and short-term storage should be considered on a case-by-case basis with properly designed testing strategies for post-incident screening of potentially exposed staff or investigation of possible LAIs.¹

Vaccines

The Advisory Committee on Immunization Practices (ACIP) provides expert advice on the most effective immunization strategies against vaccine-preventable diseases. The occupational health program should utilize ACIP guidelines for routine administration of vaccines and offer any licensed vaccine indicated to

provide risk-based agent-specific immune protection.^{1,13,44} Please refer to the agent summary statements in [Section VIII](#) for additional information on available vaccines for various biological agents.

With few exceptions, acceptance of vaccinations that are medically indicated should not be a precondition of employment in biomedical research laboratories. However, under specific legal situations, an institution may be able to exclude a worker who declines to receive a potentially protective licensed vaccine against a virulent pathogen strain from working directly with that agent. Each institution must determine the best risk management strategy for its laboratory-based workforce. The healthcare provider should counsel staff who refuse recommended immunization against a vaccine-preventable disease and document the staff members' lack of protection in the medical record.

Periodic Medical Evaluations

In most cases, there is no medical basis for requiring periodic medical evaluations for the vast majority of staff solely because they work with biological hazards. Institutions may require specific work groups to participate in periodic medical evaluations provided it is justified by a substantial risk of exposure to biohazards. The possibility of increased health risks due to potential changes in staff health status should not serve as a basis for requiring workers in biomedical research to be subjected to periodic medical evaluations; rather, staff should be offered the chance to seek medical advice when such changes occur. Staff with specific concerns, such as working with biohazards while immunocompromised or the effects of hazards on their reproductive capacity, should be directed to seek confidential medical counseling with a qualified clinician.

Screening programs for work-related infections of staff, such as post-exposure medical surveillance, contact investigations, or research settings associated with evidently elevated exposure risk to specific pathogens, should also be risk-based. Periodic testing, ostensibly to detect unrecognized workplace exposures, should be avoided unless there is an unusual constellation of risk factors that could preclude the timely recognition of LAIs. For example, a workplace risk assessment may conclude that there is sufficient residual exposure risk to *Mtb*, an easily transmissible agent with a low infectious dose and long latent period, to warrant surveillance of staff to avoid dire health consequences for unknowingly infected staff and their contacts. Before an occupational health program endeavors to screen asymptomatic staff without a recognized exposure to a specific pathogen, the provider should justify the benefit of such testing, clearly define criteria for interpretation of results, and develop plans for further investigation of indeterminate and positive test results. Any medical surveillance must meet requisite criteria.⁴⁶⁻⁴⁹

Occupational Health Support for Occupational Injuries and Potential Exposures

In case of a potential hazard exposure, the staff member must immediately perform proper first aid and follow all established agent-specific protocols. All occupational injuries, including potential exposures to a biohazard, should be reported to the occupational healthcare provider immediately. The provider should notify the supervisor and safety staff if the staff member has not already done so.

The provider must take a sufficiently detailed account of the incident to quickly determine its clinical significance. The primary source of information is typically the affected staff member. Collateral sources include safety professionals investigating the incident, the supervisor or PI, and others with knowledge of the circumstances of the incident or source materials involved. The following key factors in this step include:

- Exposure controls used at the time of the incident and work activities performed leading up to it;
- The mechanism of the potential exposure (e.g., percutaneous injury, splash to mucous membranes or skin, inhalation of an infectious aerosol);
- The nature of the potential biohazard (e.g., animal body fluid, culture medium, contaminated fomite) and inoculum size (concentration, volume);
- Characteristics of agent(s) known or suspected to be involved (e.g., species, strain); transmission in natural infection or LAI; minimum infectious or lethal dose to humans; incubation period; drug susceptibility or resistance;
- Agent viability (i.e., inactivation by chemical or physical means prior to incident) and genetic modifications (to enhance viral vector safety); and
- First aid performed at the workplace (e.g., duration and cleansing agent used, time elapsed from exposure to initiation).

The two most critical determinants that diminish the risk of infection are the immediate and adequate cleansing of the affected body area and avoidance of delays in starting appropriate post-exposure prophylaxis (PEP). When in doubt, the provider should repeat first aid. The provider should take a pertinent health and social history focused on mitigating the risk of adverse health consequences for the affected staff member and the community due to the potential exposure. This should include factors that may affect the individual's susceptibility to infection with the pathogen of concern, barriers to adherence to proposed medical management, and the potential for exposure of others during the incident or close contacts. Prior agent-specific immunization does not obviate the need for a post-exposure medical evaluation because vaccination may not fully protect against disease. PEP should be offered whenever such treatment may prevent or ameliorate illness. The provider may consult clinical specialists who have experience with the biological agents of concern. If need be, the staff member should be transferred to a medical facility that can provide

the necessary level of care.¹⁰ The occupational health program should ensure adequate medical support is available for incidents where multiple staff may have been exposed.

Clinically-Oriented, Post-Exposure Risk Assessment

In case of an occupational hazard exposure, the clinician's first priority is mitigating against the risk of further harm to the affected staff member. The occupational health program may contribute further by documenting lessons learned from each incident, thereby decreasing the chances for future exposures. To achieve both goals, it may help to distinguish between a potential biohazard and specific pathogens of concern and to stratify the risk of exposure (RoE) and risk of adverse health consequences or disease (RoD) separately.^{1,50} It may be unknown at the time of an incident whether the source material (hazard) involved harbors any potentially harmful biological agents. Some biological materials (i.e., animal or human body fluids and tissues) may present a mixed hazard with more than one specific pathogen of concern, each warranting separate RoE and RoD estimates. The RoE to a pathogen informs agent-specific subsequent clinical decision-making (e.g., initiating treatment to lower the initial RoD).

For a biohazard exposure to occur two conditions must be met: (1) a biohazard must be present (i.e., released from containment by aerosolization, splash, spill, or mishandling of a contaminated object), and (2) the staff member must come into direct contact with the biohazard. The provider must determine whether a pathogen may have been transmitted to the staff member and the mechanism of exposure is compatible with transmission of an agent of concern. Whenever the possibility of transmission of a specific biological agent cannot be excluded, the provider must estimate the level of RoD. Risk factors for infection, illness, and potential for complications include circumstances of the incident, characteristics of the biological agents involved, host factors such as immune function or pre-exposure vaccination, and the utilization of post-exposure medical countermeasures. Generally, initial estimates of RoE and RoD levels will correlate. Post-exposure medical measures such as immediate wound decontamination and PEP may lower the initial RoD estimate but they cannot eliminate the possibility of an LAI.

Post-Exposure Follow-Up Care and Testing

The provider should counsel each staff member who reports a potential occupational exposure on the significance of the incident and clearly communicate the post-exposure care plan, including treatment options, alternatives to treatment, testing procedures, and interpretation and implications of laboratory results. When PEP is recommended, the staff member should be followed closely for signs of an LAI, compliance with treatment and possible adverse medication effects. Staff exposed to infectious agents for which there is no effective PEP

must receive appropriate post-incident care tailored to the agent involved and the worker's personal health. Staff may be asked to adhere to an agent-specific monitoring protocol to facilitate early detection of a symptomatic LAI. The provider may recommend isolation of a staff member to avoid secondary transmission during the prodromal phase associated with pathogens that may render a person infectious prior to the onset of symptoms (e.g., influenza).

The optimal post-exposure testing strategy for evidence of infection depends on the pathogen of concern, potential spectrum of illness, performance of available commercial assays, and the affected worker's host risk factors. Awaiting test results, including pregnancy testing, should not delay initiation of clinically indicated and appropriately selected PEP. Certain PEP protocols, such as antiretroviral regimens, may justify targeted baseline laboratory testing.⁵¹ A serum specimen collected at the time of the incident may be useful for exposure-related surveillance; however, screening for pre-existing infection with an agent of concern should not be conducted routinely. When there are no signs or symptoms of an LAI, subsequent laboratory or imaging studies to assess if transmission occurred should be avoided in most cases. However, when there is clinical value in detecting acute infections that may remain asymptomatic for prolonged periods, post-exposure testing strategies should aim for early detection. For example, nucleic acid testing for Hepacivirus C (HCV) even before antibodies may be present or screening for latent *Mtb* infection could lead to timely recognition of the need for treatment of an LAI. For serologic assays, comparison of results from paired serum samples, collected at appropriate time points, constitutes more reliable laboratory evidence of recent infection than results of screening of a single serum specimen. Ideally, the provider performs serial serological assays, simultaneously testing aliquots of baseline serum and samples collected when specific immune markers are assumed to become detectable. The clinician may consider blinding the testing facility to the times the samples were obtained. Documented seroconversion, or a significant increase in antibody titer (at least four-fold) associated with a compatible clinical syndrome, is usually highly suggestive of acute infection. The typical timing of serial serum collections in each case may be modified by circumstances of the exposure, the agent's characteristics, host factors, and medical countermeasures taken. For example, screening too soon may fail to detect low levels of early immune markers. Repeat screening at appropriate intervals may be indicated when seroconversion may be delayed; for example, repeat screening may be indicated due to the nature of the agent (e.g., human retroviruses), the immediate use of PEP (e.g., B virus), or the affected staff members' immune system function. If a staff member is to be screened with a non-commercial assay based on expert consensus, the provider should submit samples from uninfected source(s) as negative controls, positive control samples, whenever possible, and blind the testing facility to sources and timing of sample collection. The provider should caution the exposed staff

member that the clinical utility of such assays is not the same as licensed tests and must be interpreted with extreme caution.

Post-exposure occupational health care of an affected staff member may be informed by establishing whether the biological material involved harbored specific pathogens of concern. The provider should work with the principal investigator, veterinarian, or clinician responsible for the source material to determine if testing appropriate samples could help establish if a specific infectious agent was present. Negative results may not indicate the absence of a specific infectious agent and should be interpreted with caution.

Occupational Health Support for Occupational Illnesses

Staff in biomedical research and clinical laboratories should be encouraged to seek timely care for illnesses attributable to their work. Full implementation of laboratory exposure controls at recommended Biosafety Levels clearly reduces the chance of LAIs.^{26,52} However, there is little evidence to corroborate the effectiveness of biocontainment practices in preventing occupational exposures due to underreporting and a lack of centralized data-sharing on biological hazard exposures and LAIs.⁵³ The true incidence of LAIs remains unknown and, although increased adherence to safer work practices in biomedical and microbiological laboratories has eliminated many opportunities for occupational exposures, staff remain at risk for LAIs.^{52,54} Historically, staff with proven LAIs often did not recall an antecedent exposure. Unexpectedly, serious illnesses have resulted from exposures that were deemed trivial at the time of the incident or were not recognized as an LAI at initial presentation.^{55–57} Research and clinical laboratorians who work with human pathogens, or access spaces where such agents are handled, should maintain an awareness of the timing of a febrile illness in light of their work activities. They should be encouraged (e.g., at preplacement or post-exposure medical evaluations) to have a low threshold for contacting the designated occupational health provider with the earliest signs and symptoms that could be compatible with an LAI.

The provider must conduct a risk assessment for any acutely ill staff member who handled a potential pathogen during a time span prior to the onset of symptoms equal to the pathogen's range of incubation period. In addition to a focused clinical history, the interview should include an inquiry into recent work with biological materials, potential breaches of exposure controls, adherence to biosafety practices, sick contacts at work and outside, and other plausible exposure opportunities to infectious agents (e.g., hobbies or travel). Clinicians should be aware that in cases of occupational exposures, a pathogen's typical incubation period or initial clinical presentation may differ markedly from naturally acquired infections (e.g., due to disparate exposure mechanisms or an agent's genetic modifications). Prior vaccination or infection with certain pathogens

may also affect the clinical course of an LAI with a related infectious agent (e.g., tick-borne encephalitis or dengue). Close-working relationships among all stakeholders and ready access to expert medical care are absolutely essential to an adequate LAI response. Risk stratification of a possible LAI follows the same considerations as a post-incident evaluation except in a retrospective fashion and with increased emphasis on risk for the ill staff member's close contacts who may be subject to contemporaneous workplace exposure or secondary transmission. The occupational health program should be prepared to work with supervisors and biosafety professionals to conduct workplace contact investigations or case finding, taking care to balance the needs for privacy protection and infection control. An LAI that meets criteria for a reportable disease requires notification of public health authorities.

Additional workplace hazards and ergonomic conditions in the laboratory environment may give rise to work-related health conditions that may diminish staff's ability to work safely with human pathogens such as work-related musculoskeletal disorders or occupationally acquired allergies. In most cases, allergies to laboratory animals develop within the first year of occupational exposure to the allergens. Of the 20 to 30% of workers who become allergic to animal proteins, 5% may progress to asthma that may, rarely, threaten workers' lives and livelihood due to anaphylaxis.^{1,7} The occupational health program should be prepared to evaluate and treat these conditions to ensure a safe return of staff to full duty.

Occupational Health Support of Staff in High and Maximum Biocontainment

Adequate occupational health support of research in BSL-3 and BSL-4 laboratories may pose special challenges for occupational health providers.⁵⁸ BSL-3, BSL-4, and associated animal facilities (i.e., ABSL-3, ABSL-4, and the high containment facilities described for open penned or loose-housed animals in [Appendix D](#)) are designed to minimize the risk of exposure to high-consequence biological agents for workers, the community, and the environment.^{59,60} See [Sections III, IV, V, and Appendix D](#) for additional information. BSL-3 or BSL-4 researchers who participate in field research or outbreak response involving RG3 or RG4 pathogens may need additional occupational health services due to increased exposure risks.⁶¹

The same principles of incident and illness response outlined above apply to potential hazard exposures and LAIs in a BSL-3 or BSL-4 laboratory environment, but with an increased concern for public health and potential harm to society if RG3 or RG4 agents were to be released, diverted, or intentionally misused. See [Section VI](#) for additional information about laboratory biosecurity. A staff member with access to RG3 or RG4 pathogens who develops an unexplained acute febrile illness should seek medical consultation at the earliest onset of symptoms.

Supervisory staff may encourage RG3 and RG4 agent researchers to contact the designated medical provider in case of a possible LAI, rather than seeking care from a community-based medical provider who may be less familiar with hazards involved. Depending on risk, a fever watch for the duration of the incubation period, with calls to the occupational health program in the event of a fever, may be a useful component of institutional emergency preparedness. Advance planning for appropriate care in case of an occupational exposure or possible LAI is a fundamental component of an occupational health program supporting research of RG3 or RG4 pathogens.⁹ The designated medical provider may forge liaisons with clinical programs capable of the requisite advanced level of care for patients infected with high-consequence pathogens.^{10,50,62} Incident and illness response plans should also include timely and appropriate notification of local health authorities as warranted by the circumstances in each case.

Conclusion

Occupational health support for a biomedical research community should consist of select, expert services tailored to address the risks identified for the individual staff member and the institution and commensurate with the scope of work involving potential biological hazards. The strength of an occupational health program supporting staff in laboratories or animal care facilities where such biological materials are present depends on sound coordination with each component of the institution's occupational safety and health operations. The occupational healthcare provider has a vital role in the health, safety, and security of staff in the biomedical research environment and the establishment of a robust culture of safety.

References

1. Schmitt JM. Occupational medicine in a biomedical research setting. In: Wooley DP, Byers KB, editors. *Biological Safety: Principles and Practices*. 5th ed. Washington (DC): ASM Press; 2017. p. 511–17.
2. Burnett LC. Developing a biorisk management program to support biorisk management culture. In: Wooley DP, Byers KB, editors. *Biological Safety: Principles and Practices*. 5th ed. Washington (DC): ASM Press; 2017. p. 495–510.
3. Wooley DP, Fleming DO. Risk assessment of biological hazards. In: Wooley DP, Byers KB, editors. *Biological Safety: Principles and Practices*. 5th ed. Washington (DC): ASM Press; 2017. p. 95–104.
4. Centers for Disease Control and Prevention [Internet]. Atlanta (GA): The National Institute for Occupational Safety and Health (NIOSH); c2015 [cited 2019 Mar 6]. Hierarchy of Controls. Available from: <https://www.cdc.gov/niosh/topics/hierarchy/default.html>

5. Wiedermann U, Garner-Spitzer E, Wagner A. Primary vaccine failure to routine vaccines: Why and what to do?. *Hum Vaccin Immunother.* 2016;12(1):239–43.
6. Wilde H. Failures of post-exposure rabies prophylaxis. *Vaccine.* 2007;25(44):7605–9.
7. Schmitt JM, Wilson DE, Raber JM. Occupational Safety and Health. In: Weichbrod RH, Thompson GA, Norton JN, editors. *Management of animal care and use programs in research, education, and testing.* 2nd ed. Boca Raton (FL): CRC Press; 2018. p. 279–318.
8. Delany JR, Pentella MA, Rodriguez JA, Shah KV, Baxley KP, Holmes DE; Centers for Disease Control and Prevention. Guidelines for biosafety and laboratory competency: CDC and the Association of Public Health Laboratories. *MMWR Suppl.* 2011;60(2):1–23.
9. Federal Select Agent Program [Internet]. Atlanta (GA); Riverdale (MD): Centers for Disease Control and Prevention; Animal and Plant Inspection Service; c2018 [cited 2019 Mar 6]. Occupational Health Program. Available from: <https://www.selectagents.gov/ohp-intro.html>
10. Jahrling P, Rodak C, Bray M, Davey RT. Triage and management of accidental laboratory exposures to biosafety level-3 and -4 agents. *Bio Secur Bioterror* 2009;7(2):135–43.
11. Fischman ML, Goldstein DA, Cullen MR. Emerging Technologies. In: Rosenstock L, Cullen MR, Brodtkin CA, Redlich CA, editors. *Textbook of Clinical Occupational and Environmental Medicine.* 2nd ed. Philadelphia: Elsevier Saunders; 2005. p. 263–71.
12. Kim DK, Riley LE, Hunger P. Advisory Committee on Immunization Practices recommended immunization schedule for adults aged 19 years or older—United States, 2018. *MMWR Morb Mortal Wkly Rep.* 2018;67(5):158–60.
13. Centers for Disease Control and Prevention [Internet]. Atlanta (GA): National Center for Immunization and Respiratory Disease; c2019 [cited 2019 Mar 6]. ACIP Vaccine Recommendations and Guidelines. Available from: <https://www.cdc.gov/vaccines/hcp/acip-recs/index.html>
14. Centers for Disease Control and Prevention [Internet]. Atlanta (GA): National Center for Emerging and Zoonotic Infectious Diseases, Division of Healthcare Quality Promotion; c2016 [cited 2019 Mar 6]. Infection Control. Available from: <https://www.cdc.gov/infectioncontrol/index.html>
15. Menckel EWA, Westerholm P, editors. *Evaluation in occupational health practice.* 1st ed. Oxford: Butterworth-Heinemann; 1999.
16. Levy BS, Wegman DH, editors. *Occupational Health: Recognizing and Preventing Work-related Disease and Injury.* 4th ed. Philadelphia: Lippincott Williams & Wilkins; 2000.

17. National Institutes of Health. NIH Guidelines for Research Involving Recombinant or Synthetic Nucleic Acid Molecules (NIH Guidelines). Bethesda (MD): National Institutes of Health, Office of Science Policy; 2019.
18. Federal Select Agent Program [Internet]. Atlanta (GA); Riverdale (MD): Centers for Disease Control and Prevention; Animal and Plant Health Inspection Service; c2017 [cited 2019 Mar 6]. Select Agents Regulations. Available from: <https://www.selectagents.gov/regulations.html>
19. Occupational Safety and Health Administration. Laboratory Safety Guidance. OSHA 3404-11R. Washington (DC): U.S. Department of Labor; 2011.
20. Bloodborne pathogens, 29 C.F.R. Part 1910.1030 (1992).
21. Americans with Disabilities Act [Internet]. Washington (DC): Department of Justice Civil Rights Division; [cited 2019 Mar 6]. Fighting Discrimination in Employment Under the ADA. Available from: <https://www.ada.gov/employment.htm>
22. U.S. Equal Employment Opportunity Commission [Internet]. Washington (DC): Office of Legal Counsel; c2015 [cited 2019 Mar 6]. Enforcement Guidance: Pregnancy Discrimination and Related Issues. No. 915.003. Available from: https://www.eeoc.gov/laws/guidance/pregnancy_guidance.cfm
23. U.S. Department of Health and Human Services [Internet]. Washington (DC): Office for Civil Rights Headquarters; c2017 [cited 2019 Mar 6]. Your Rights Under HIPAA. Available from: <https://www.hhs.gov/hipaa/for-individuals/guidance-materials-for-consumers/index.html>
24. American Medical Association [Internet]. Chicago (IL): Ethics; c1995–2019 [2019 Mar 6]. Code of Medical Ethics: Privacy, confidentiality & medical records. Available from: <https://www.ama-assn.org/delivering-care/ethics/code-medical-ethics-privacy-confidentiality-medical-records>
25. National Institutes of Health [Internet]. Bethesda (MD): National Institute of Allergy and Infectious Diseases; c2018 [cited 2019 Mar 6]. The Need for Biosafety Labs. Available from: <https://www.niaid.nih.gov/research/biosafety-labs-needed>
26. Wurtz N, Papa A, Hukic M, Di Caro A, Leparac-Goffart I, Leroy E, et al. Survey of laboratory-acquired infections around the world in biosafety level 3 and 4 laboratories. *Eur J Clin Microbiol Infect Dis*. 2016;35(8):1247–58.
27. Richards SL, Pompei VC, Anderson A. BSL-3 laboratory practices in the United States: comparison of select agent and non-select agent facilities. *Biosecur Bioterror*. 2014;12(1):1–7.
28. Condrey JP, Kost TA, Mickelson CA. Emerging considerations in virus-based gene transfer systems. In: Wooley DP, Byers KB, editors. *Biological Safety: Principles and Practices*. 5th ed. Washington (DC): ASM Press; 2017. p. 221–46.

29. Howard J, Murashov V, Schulte P. Synthetic biology and occupational risk. *J Occup Environ Hyg*. 2017;14(3):224–36.
30. Wooley DP. Molecular agents. In: Wooley DP, Byers KB, editors. *Biological Safety: Principles and Practices*. 5th ed. Washington (DC): ASM Press; 2017. p. 269–83.
31. Schlimgen R, Howard J, Wooley D, Thompson M, Baden LR, Yang OO, et al. Risks associated with lentiviral vectors exposures and prevention strategies. *J Occup Environ Med*. 2016;58(12):1159–66.
32. National Institutes of Health [Internet]. Bethesda (MD): Office of Science Policy; [cited 2019 Mar 6]. Biosafety, Biosecurity, and Emerging Biotechnology. Available from: <https://osp.od.nih.gov/biosafety-biosecurity-and-emerging-biotechnology/>
33. National Research Council. *Occupational Health and Safety in the Care and Use of Research Animals*. Washington (DC): National Academy Press; 1997.
34. Hankenson FC, Johnston NA, Weigler BJ, Di Giacomo RF. Zoonoses of occupational health importance in contemporary laboratory animal research. *Comp Med*. 2003;53(6):579–601.
35. Bailey C, Mansfield K. Emerging and Reemerging Infectious Diseases of Nonhuman Primates in the Laboratory Setting. *Vet Pathol*. 2010;47(3):462–81.
36. Willy ME, Woodward RA, Thornton VB, Wolff AV, Flynn BM, Heath JL, et al. Management of a measles outbreak among Old World nonhuman primates. *Lab Anim Sci*. 1999;49(1):42–8.
37. Occupational Safety and Health Standards. Respiratory protection, 29 C.F.R. Sect. 1910.134 (2006).
38. OSHA Instruction. Hearing Conservation Program, PER 04-00-004 (2008).
39. Miller JM, Astles R, Baszler T, Chapin K, Carey R, Garcia L, et al. Guidelines for safe work practices in human and animal medical diagnostic laboratories. Recommendations of a CDC-convened, Biosafety Blue Ribbon Panel. *MMWR Suppl*. 2012;61(1):1–102. Erratum in: *MMWR Surveill Summ*. 2012;61(12):214.
40. Centers for Disease Control and Prevention; Animal and Plant Health Inspection Service. Incident Response Plan Guidance [Internet]. Federal Select Agent Program; 2018 [cited 2019 Aug 9]. Available from: https://www.selectagents.gov/resources/Incident_Response_Plan.pdf
41. Belk HD. Implementing continuous quality improvement in occupational health programs. *J Occup Med*. 1990;32(12):1184–8.

42. U.S. Department of Labor [Internet]. Washington (DC): Bureau of Labor Statistics; c2013 [cited 2019 Mar 6]. Using workplace safety and health data for injury prevention. Available from: <https://www.bls.gov/opub/mlr/2013/article/using-workplace-safety-data-for-prevention.htm>
43. Peterson JS, Morland MA. Measuring biosafety program effectiveness. In: Wooley DP, Byers KB, editors. *Biological Safety: Principles and Practices*. 5th ed. Washington (DC): ASM Press; 2017. p. 519–36.
44. Advisory Committee on Immunization Practices; Centers for Disease Control and Prevention (CDC). Immunization of Health-Care Personnel: Recommendations of the Advisory Committee on Immunization Practices (ACIP). *MMWR Recomm Rep*. 2011;60(RR-7):1–45.
45. Tuck MK, Chan DW, Chia D, Godwin AK, Grizzle WE, Krueger KE, et al. Standard operating procedures for serum and plasma collection: early detection research network consensus statement standard operating procedure integration working group. *J Proteome Res*. 2009;8(1):113–7.
46. Occupational Safety and Health Administration Medical Screening and Surveillance Requirements in OSHA Standards: A Guide. OSHA 3162-01R. Washington (DC): U.S. Department of Labor; 2014.
47. Baker EL, Matte TP. Occupational Health Surveillance. In: Rosenstock L, Cullen MR, Brodtkin CA, Redlich CA, editors. *Textbook of Clinical Occupational and Environmental Medicine*. 2nd ed. Philadelphia: Elsevier Saunders; 2005. p. 76–82.
48. Koh D, Aw T-C. Surveillance in occupational health. *Occup Environ Med*. 2003;60:705–10.
49. Manno M, Sito F, Licciardi L. Ethics of biomonitoring for occupational health. *Toxicol Lett*. 2014;231(2):111–21.
50. Rusnak JM, Kortepeter MG, Aldis J, Boudreau E. Experience in the medical management of potential laboratory exposures to agents of bioterrorism on the basis of risk assessment at the United States Army Medical Research Institute of Infectious Diseases (USAMRIID). *J Occup Environ Med*. 2004;46(8):801–11.
51. Kuhar DT, Henderson DK, Struble KA, Heneine W, Thomas V, Cheever LW, et al. Updated US Public Health Service Guidelines for the Management of Occupational Exposures to Human Immunodeficiency Virus and Recommendations for Postexposure Prophylaxis. *Infect Control Hosp Epidemiol*. 2013;34(9):875–92.
52. Byers KB, Harding AL. Laboratory-associated infections. In: Wooley DP, Byers KB, editors. *Biological Safety: Principles and Practices*. 5th ed. Washington (DC): ASM Press; 2017. p. 59–92.

53. Kimman TG, Smit E, Klein MR. Evidence-Based Biosafety: a Review of the Principles and Effectiveness of Microbiological Containment Measures. *Clin Microbiol Rev.* 2008;21(3):403–25.
54. Siengsanon-Lamont J, Blacksell SD. A Review of Laboratory-Acquired Infections in the Asia-Pacific: Understanding Risk and the Need for Improved Biosafety for Veterinary and Zoonotic Diseases. *Trop Med Infect Dis.* 2018;3(2). pii: E36.
55. Cohen JI, Davenport DS, Stewart JA, Deitchman S, Hilliard JK, Chapman LE, et al. Recommendations for prevention of and therapy for exposure to B virus (Cercopithecine herpesvirus 1). *Clin Infect Dis* 2002;35(10):1191–203.
56. Centers for Disease Control and Prevention. Fatal Laboratory-Acquired Infection with an Attenuated *Yersinia pestis* Strain—Chicago, Illinois, 2009. *MMWR Morb Mortal Wkly Rep.* 2011;60(7):201–5.
57. Sheets CD, Harriman K, Zipprich J, Louie JK, Probert WS, Horowitz M, et al. Fatal Meningococcal Disease in a Laboratory Worker—California, 2012. *MMWR Morb Mortal Wkly Rep.* 2014;63(35):770–2.
58. Crane JT, Richmond JY. Design of biomedical laboratory and specialized biocontainment facilities. In: Wooley DP, Byers KB, editors. *Biological Safety: Principles and Practices.* 5th ed. Washington (DC): ASM Press; 2017. p. 343–66.
59. Rusnak JM, Kortepeter MG, Hawley RJ, Anderson AO, Boudreau E, Eitzen E. Risk of occupationally acquired illnesses from biological threat agents in unvaccinated laboratory researchers. *Biosecur Bioterror.* 2004;2(4):281–93.
60. Bressler DS, Hawley RJ. Safety considerations in the biosafety level 4 maximum-containment laboratory. In: Wooley DP, Byers KB, editors. *Biological Safety: Principles and Practices.* 5th ed. Washington (DC): ASM Press; 2017. p. 695–717.
61. Kortepeter MG, Cieslak TJ, Kwon EH, Smith PW, Kratochvil CJ, Hewlett AL. Comment on “Ebola virus infection among Western healthcare workers unable to recall the transmission route.” *Biomed Res Int.* 2017;2017:7458242.
62. Risi GF, Bloom ME, Hoe NP, Arminio T, Carlson P, Powers T, et al. Preparing a community hospital to manage work-related exposures to infectious agents in biosafety level 3 and 4 laboratories. *Emerg Infect Dis.* 2010;16(3):373–8.

Section VIII—Agent Summary Statements

The agent summary statements contained in [Section VIII](#) of the sixth edition of *Biosafety in Microbiological and Biomedical Laboratories (BMBL)* are designed to assist the reader with the risk assessment for their work, as directed in [Section II](#). The statements are assembled by subject matter experts and represent a summary of key information regarding pathogens with significance to the biomedical community. Although the statements provide recommendations regarding containment for specific activities, they should serve only as the starting point for a laboratory's risk assessment and should not serve as a substitute for an assessment. The statements cannot fully factor in the change in risk due to the size of a sample, concentration of agent present, change in virulence or pathogenicity, nor any change in ability to provide medical countermeasures due to antibiotic or antiviral resistance.

The following list of agents is also not comprehensive, and the reader is directed to other information to assist in the risk assessment, including the Public Health Agency of Canada's Pathogen Safety Data Sheets (PSDS),¹ the American Public Health Association's Control of Communicable Diseases Manual,² American Society for Microbiology Manual of Clinical Microbiology,³ and the ABSA International Risk Group Database.⁴

References

1. Government of Canada [Internet]. Canada: Public Health Agency of Canada; c2018 [cited 2018 Dec 20]. Pathogen Safety Data Sheets. Available from: <https://www.canada.ca/en/public-health/services/laboratory-biosafety-biosecurity/pathogen-safety-data-sheets-risk-assessment.html>
2. Heymann DL, editor. Control of Communicable Diseases Manual. 20th ed. Washington (DC): American Public Health Association; 2014.
3. Jorgensen JH, Pfaller MA, Carroll KC, Funke G, Landry ML, Richter SS, et al, editors. Manual of Clinical Microbiology. 11th ed. Washington (DC): American Society for Microbiology; 2015.
4. American Biological Safety Association [Internet]. ABSA International; c2018 [cited 2018 Dec 20]. Risk Group Database. Available from: <https://my.absa.org/tiki-index.php?page=Riskgroups>

Section VIII-A: Bacterial Agents

Bacillus anthracis

Bacillus anthracis, a Gram-positive, non-hemolytic, and non-motile bacillus, is the etiologic agent of anthrax, an acute bacterial disease among wild and domestic mammals, including humans. Like all members of the genus *Bacillus*, under adverse conditions, *B. anthracis* has the ability to produce spores that allow the organism to persist for long periods (i.e., years), withstanding heat and drying, until the return of more favorable conditions for vegetative growth.¹ It is because of this ability to produce spores coupled with significant pathogenic potential in humans that this organism is considered one of the most serious and threatening biowarfare or bioterrorism agents.² Most mammals are susceptible to anthrax; it mostly affects herbivores that ingest spores from contaminated soil and, to a lesser extent, carnivores that scavenge on the carcasses of diseased animals. In the United States, it occurs sporadically in animals in parts of the West, Midwest, and Southwest. Human case rates for anthrax are highest in Africa and central and southern Asia.³ The infectious dose varies greatly from species to species and is route-dependent. The inhalation anthrax infectious dose (ID) for humans has been primarily extrapolated from inhalation challenges of non-human primates (NHPs) or studies done in contaminated wool mills. Estimates vary greatly but the median lethal dose (LD50) is likely within the range of 2,500–55,000 spores.⁴ It is believed that very few spores (ten or fewer) are required for cutaneous anthrax infection.⁵ Anthrax cases have been rare in the United States since the first half of the 20th century. The mortality rates have been reported to be approximately 20% for cutaneous anthrax without antibiotics, 25–75% for gastrointestinal anthrax, and 80% or more for inhalation anthrax. With treatment, <1% of cutaneous anthrax cases are fatal. The fatality rate of a series of inhalation anthrax cases in 2001 was 36% with antibiotics.^{6,7} *Bacillus cereus* biovar *anthracis*, if inhaled, can produce symptoms similar to inhalation anthrax. Rapid rule-out tests to differentiate *B. cereus* biovar *anthracis* from other *Bacillus* spp. are currently not available.⁶

Occupational Infections

Occupational infections are possible when in contact with contaminated animals, animal products, or pure cultures of *B. anthracis*, and may include ranchers, veterinarians, and laboratory workers. Although numerous cases of laboratory-associated anthrax (primarily cutaneous) were reported in earlier literature, in recent years, cases of anthrax due to laboratory accidents have been rare in the United States.^{8,9}

Natural Modes of Infection

The clinical forms of anthrax in humans that result from different routes of infection include:

1. Cutaneous (via broken skin);
2. Gastrointestinal (via ingestion);
3. Inhalation anthrax;¹⁰ and
4. Injection (to date, identified in heroin-injecting drug users in northern Europe).^{11,12}

Cutaneous anthrax is the most common (> 95% of human cases worldwide) and is a readily treatable form of the disease. While naturally occurring disease is no longer a significant public health problem in the United States, *B. anthracis* has become a bioterrorism concern. In 2001, 22 people were diagnosed with anthrax acquired from spores sent through the mail, including 11 cases of inhalation anthrax with five deaths and 11 cutaneous cases.¹³ A report of accidental shipment of live organisms highlights the importance of adherence to handling guidelines.¹⁴ The approach to prevention and treatment of anthrax differs from that for other bacterial infections. When selecting post-exposure prophylaxis or a combination of antimicrobial drugs for treatment of anthrax, it is recommended to consider the production of toxin, the potential for antimicrobial drug resistance, the frequent occurrence of meningitis, and the presence of latent spores.¹⁵

Laboratory Safety and Containment Recommendations

B. anthracis may be present in blood, skin lesion exudates, cerebrospinal fluid (CSF), pleural fluid, sputum, and rarely, in urine and feces.¹² Primary hazards to laboratory personnel are: direct and indirect contact of broken skin with cultures and contaminated laboratory surfaces, accidental parenteral inoculation and, rarely, exposure to infectious aerosols. Spores are resistant to many disinfectants and may remain viable on some surfaces for years.

BSL-3 practices, containment equipment, and facilities are recommended for work involving production quantities or high concentrations of cultures, screening environmental or unknown samples (especially powders) from anthrax-contaminated locations, diagnostics or suspected anthrax samples, and for activities with a high potential for aerosol production. As soon as *B. anthracis* is suspected in the sample, BSL-3 practices are recommended for further culture and analysis. BSL-2 practices, containment equipment, and facilities are recommended for primary inoculation of cultures from potentially infectious clinical materials. ABSL-2 practices, containment equipment, and facilities are recommended for studies utilizing experimentally infected laboratory rodents. It is recommended that all centrifugation be performed using autoclavable, aerosol-tight rotors or safety cups that are opened within the BSC after each run. In addition, it is recommended to collect routine surveillance swabs for culture inside the rotor and rotor lid and, if contaminated, it is recommended to autoclave rotors before re-use.

Special Issues

Be advised of possible misidentification using automated systems. For identification using MALDI-TOF MS, it is recommended to use alternative tube extraction that kills viable organisms in the BSC, followed by filtration through a 0.1–0.2 µm filter to remove any remaining viable cells or spores, and not direct spotting of plates in the open laboratory.^{15,16}

Vaccines Control of anthrax begins with control of the disease in livestock, and vaccination of livestock has long been central to control programs. Human anthrax is best controlled through prevention, including (a) pre-exposure vaccination for persons at high-risk for encountering aerosolized *B. anthracis* spores, (b) reduction of animal illness by vaccination of livestock at risk for anthrax, and (c) environmental controls to decrease exposure to contaminated animal products, such as imported hair and skins. After a person is exposed to aerosolized *B. anthracis* spores, a combination of antimicrobials and vaccine provides the best available protection.¹⁷ A licensed vaccine for anthrax in humans is available, the anthrax vaccine adsorbed (AVA). AVA is produced from the protective antigen of an attenuated non-encapsulated strain of *B. anthracis*. The vaccine is approved by the Food and Drug Administration (FDA) for at-risk adults before exposure to anthrax. Guidelines for its use in occupational settings are available from the ACIP.¹⁸ CDC has reviewed and updated guidelines for anthrax post-exposure prophylaxis and treatment.¹⁷ Vaccination is not recommended for workers involved in routine processing of clinical specimens or environmental swabs in general clinical diagnostic laboratories. Of interest, Obiltoximab, a novel monoclonal antibody directed against the protective antigen of *B. anthracis*, which plays a key role in the pathogenesis of anthrax, has received approval for treatment and prevention of inhalational anthrax.¹⁹ Because of the limited potential of antibiotic treatment once toxemia has already set in, numerous strategies are being explored for therapy directed against the action of anthrax toxins.²⁰

Select Agent *B. anthracis* and *Bacillus cereus* biovar *anthracis* are Select Agents requiring registration with CDC and/or USDA for possession, use, storage and/or transfer. See [Appendix F](#) for additional information.

Transfer of Agent Importation of this agent requires CDC and/or USDA importation permits. Domestic transport of this agent may require a permit from USDA APHIS VS. A Department of Commerce (DoC) permit may be required for the export of this agent to another country. See [Appendix C](#) for additional information.

Bordetella pertussis

Bordetella pertussis, an exclusively human respiratory pathogen of worldwide distribution, is the etiologic agent of whooping cough or pertussis. The organism

is a fastidious, small, Gram-negative coccobacillus that requires specialized culture and transport media for cultivation in the laboratory.²¹ Alternatively, infection may be diagnosed by molecular methodologies on a direct specimen. Its natural habitat is the human respiratory tract.

Occupational Infections

Occupational transmission of pertussis has been reported, primarily among healthcare workers.²² Outbreaks, including secondary transmission, among workers have been documented in hospitals, long-term care institutions, and laboratories. Nosocomial transmission has been reported in healthcare settings and laboratory-associated pertussis has also been documented.^{23,24}

Natural Modes of Infection

Pertussis is highly communicable, with person-to-person transmission occurring via aerosolized respiratory secretions (droplets) containing the organism. The attack rate among susceptible hosts is affected by the frequency, proximity, and time of exposure to infected individuals; however, transmission rates to susceptible contacts may be close to 90% with the infectious dose only around 100 CFU.²¹ Although the number of reported pertussis cases declined by over 99% following the introduction of vaccination programs in the 1940s, the incidence of pertussis remains cyclical, with epidemic peaks occurring every three to five years within a given region.²⁵ In 2015, the World Health Organization reported 142,512 pertussis cases globally and estimated that there were 89,000 deaths attributed to pertussis.²⁶ However, a recent publication modeling pertussis case and death estimates proposed that there were 24.1 million pertussis cases and 160,700 deaths in children younger than five years in 2014 worldwide.²⁷ Of significance, *B. pertussis* continues to circulate in populations despite high vaccination of infants and children because protection wanes after several years.²⁸

Nevertheless, in vaccinating countries, although pertussis is primarily observed in neonates, infections are found in under-vaccinated or unvaccinated individuals of all ages, including young infants, older school children, adolescents, and adults.^{27–29} Adults and adolescents with atypical or undiagnosed *B. pertussis* infections are a primary reservoir. Pertactin is an outer membrane protein and virulence factor for *B. pertussis*, and it should be noted that pertactin-negative strains may evade vaccine-mediated immunity.³⁰

Laboratory Safety and Containment Recommendations

The agent may be present in high levels in respiratory secretions and may be found in other clinical material, such as blood and lung tissue.^{31,32} Aerosol generation during the manipulation of cultures and contaminated clinical specimens generate the greatest potential hazard. Direct contact is also a hazard with the agent being able to survive a number of days on surfaces such as clothing.

BSL-3 practices, containment equipment, and facilities are appropriate for production operations. BSL-2 practices, containment equipment, and facilities are recommended for all activities involving the use or manipulation of known or potentially infectious clinical material and cultures. ABSL-2 practices and containment equipment are recommended for housing experimentally infected animals. Primary containment devices and equipment, including biological safety cabinets, safety centrifuge cups, or sealed rotors are recommended for activities likely to generate potentially infectious aerosols.

Special Issues

Vaccines A number of pertussis vaccines are available for infants, children, preteens, teens, and adults. DTaP (Diphtheria/Tetanus/Pertussis) is the childhood vaccine, and Tdap (Tetanus/Diphtheria/Pertussis) is the pertussis booster vaccine for preteens, teens, and adults.³³

Transfer of Agent Importation of this agent requires CDC and/or USDA importation permits. Domestic transport of this agent may require a permit from USDA APHIS VS. A DoC permit may be required for the export of this agent to another country. See [Appendix C](#) for additional information.

Brucella species

The genus *Brucella* consists of slow-growing, very small, Gram-negative coccobacilli whose natural hosts are mammals. The taxonomy of *Brucella* species remains in flux; however, this genus currently includes 10 recognized species:

- Six terrestrial
 - *B. melitensis* (preferred hosts: sheep, goats, and camels)
 - *B. suis* (preferred hosts: swine and other wild animals)
 - *B. abortus* (natural hosts: cattle and buffalo)
 - *B. canis* (natural host: dogs)
 - *B. ovis* (natural host: rams)
 - *B. neotomae* (natural host: desert and wood rats)
- Three marine
 - *B. delphini*
 - *B. pinnipedialis*
 - *B. ceti*
- One proposed species of unknown origin.³⁴

High-risk species for human infections include *Brucella abortus*, *B. melitensis*, and *B. suis*. There is a wide spectrum of clinical manifestations, and patients may have an extended recovery period. Mortality is estimated to be less than 1%.^{34,35}

Occupational Infections

Brucellosis is a frequently reported Laboratory-associated infection.^{34–38} Airborne and mucocutaneous exposures can produce Laboratory-associated infections. Many cases of laboratory-associated disease appear to be due to mishandling and misidentification of the organism.³⁹ The need to improve compliance with recommended guidelines was highlighted when 916 laboratory workers were exposed to the RB51 vaccine strain, which is known to cause human illness, due to mishandling of a proficiency test sample.⁴¹ Brucellosis is an occupational disease for workers who handle infected animals or their tissues. Accidental self-inoculation with vaccine strains is an occupational hazard for veterinarians and other animal handlers.

Natural Modes of Infection

Brucellosis (Undulant fever, Malta fever, Mediterranean fever) is a zoonotic disease of worldwide occurrence. Mammals, particularly cattle, goats, swine, and sheep, act as reservoirs for *Brucella* spp. as animals are generally asymptomatic. Multiple routes of transmission have been identified, including direct contact with infected animal tissues or products, ingestion of contaminated milk, and airborne exposure in animal pens and stables.

Laboratory Safety and Containment Recommendations

Brucella may be found in a wide variety of body tissues, including blood, CSF, semen, pulmonary excretions, placenta, and occasionally urine. Most laboratory-associated cases occur in research facilities and involve exposures to zoonotic *Brucella* organisms grown in large quantities or exposure to placental tissues containing zoonotic *Brucella* spp. Cases have also occurred in clinical laboratory settings from sniffing bacteriological cultures or working on open benchtops.^{42,43} Human infections are commonly attributed to exposure to aerosols or direct skin contact with cultures or infectious animal specimens.^{43,44} The infectious dose of *Brucella* is 10–100 organisms by aerosol or subcutaneous routes in laboratory animals.^{45,46} *Brucella* spp. are environmentally stable, surviving days to months in carcasses and organs, in soil and on surfaces.^{45,46}

BSL-3 practices, containment equipment, and facilities are recommended for all manipulations of cultures of pathogenic *Brucella* spp. BSL-3 practices are recommended when handling products of conception or clinical specimens suspected to contain *Brucella*.¹² ABSL-3 practices are recommended for experimental animal studies. BSL-2 practices, containment equipment, and facilities are recommended for routine handling of clinical specimens of human or animal origin.

Special Issues

Be advised of possible misidentification using automated systems. For identification using MALDI-TOF MS, it is recommended to use alternative tube extraction that kills viable organisms and not direct spotting of plates in the open laboratory.

Vaccines Human *Brucella* vaccines have been developed and tested in other countries with limited success.⁴⁹ Although a number of successful vaccines are available for immunization of animals, no licensed human vaccines are currently available. Some recently described ribosomal proteins and fusion proteins demonstrate a protective effect against *Brucella* based on antibody and cell-mediated responses, which may prove useful in potential vaccines.³⁴

Select Agent *Brucella abortus*, *B. melitensis*, and *B. suis* are Select Agents requiring registration with CDC and/or USDA for possession, use, storage and/or transfer. See [Appendix F](#) for additional information.

Transfer of Agent Importation of this agent requires CDC and/or USDA importation permits. Domestic transport of this agent may require a permit from USDA APHIS VS. A DoC permit may be required for the export of this agent to another country. See [Appendix C](#) for additional information.

Burkholderia mallei

Burkholderia mallei is a non-motile, Gram-negative rod associated with glanders, a disease primarily of equine species, but which can be seen in humans. While endemic foci of infection exist in some areas of the world, glanders due to natural infection is extremely rare in the United States with the last naturally occurring case reported in 1934.⁵⁰ Reported mortality rates are over 90% if left untreated, and up to 50% with treatment.⁵⁰

Occupational Infections

Glanders occurs almost exclusively among individuals who work with equine species and/or handle *B. mallei* cultures in the laboratory. *B. mallei* can be very infectious in the laboratory setting. The only reported case of human glanders in the United States over the past 50 years resulted from a laboratory exposure.⁵¹ Modes of transmission may include inhalation and/or mucocutaneous exposure.

Natural Modes of Infection

Glanders is a highly communicable disease of solipeds (such as horses, goats, and donkeys). Zoonotic transmission occurs to humans, but person-to-person transmission is rare. Glanders in solipeds and humans has been eradicated from North America and Western Europe. However, sporadic infections of animals are still reported in Far East Asia, South America, Eastern Europe, North Africa, and the Middle East.⁵⁰ Clinical manifestations in humans include localized

infection, pulmonary infection, bacteremia, or chronic infection, characterized by suppurative tissue abscesses. The organism is transmitted by direct invasion of abraded or lacerated skin; inhalation with deep lung deposition; and by bacterial invasion of the nasal, oral, and conjunctival mucous membranes. Occupational exposures most often occur through exposed skin.⁵⁰

Laboratory Safety and Containment Recommendations

B. mallei can be hazardous in a laboratory setting. Laboratory-associated infections have resulted from aerosol and cutaneous exposure. A laboratory-associated infection in 2001 was the first case of glanders reported in the United States in over 50 years.^{51,52} The ability of *B. mallei* to survive for up to 30 days in water at room temperature should be a consideration in development and implementation of safety, disinfection, and containment procedures for laboratories and animal facilities handling this agent.

BSL-3 and ABSL-3 practices, containment equipment, and facilities are recommended for all manipulations of suspect cultures, animal necropsies, and for experimental animal studies. BSL-3 practices are recommended for preparatory work on cultures or contaminated materials for automated identification systems. BSL-3 practices, containment equipment, and facilities are appropriate for production operations. BSL-2 practices, containment equipment, and facilities are recommended for primary inoculation of cultures from potentially infectious clinical materials. Primary containment devices and equipment, including biological safety cabinets, safety centrifuge cups, or sealed rotors are recommended for activities likely to generate potentially infectious aerosols.

Special Issues

Be advised of possible misidentification using automated systems. For identification using MALDI-TOF MS, it is recommended to use alternative tube extraction that kills viable organisms and not direct spotting of plates in the open laboratory.

Vaccines Vaccine research and development has been conducted, but there is no available vaccine.⁵³

Select Agent *B. mallei* is a Select Agent requiring registration with CDC and/or USDA for possession, use, storage and/or transfer. See [Appendix F](#) for additional information.

Transfer of Agent Importation of this agent requires CDC and/or USDA importation permits. Domestic transport of this agent may require a permit from USDA APHIS VS. A DoC permit may be required for the export of this agent to another country. See [Appendix C](#) for additional information.

Burkholderia pseudomallei

Burkholderia pseudomallei is a motile, Gram-negative, oxidase-positive rod that is found in soil and water environments of equatorial regions, including Southeast Asia, Northern Australia, Madagascar, Africa, India, China, Taiwan, Central America, and South America.⁵⁴ This organism, the causative agent of melioidosis, is capable of infecting both humans and animals. A recent study estimates the global incidence of melioidosis is 165,000 cases with 89,000 deaths.⁵⁵

Occupational Infections

Melioidosis is a disease associated with activities that expose people to soil and water such as rice farming or gardening; however, *B. pseudomallei* can be hazardous for laboratory workers, with two possible cases of aerosol transmission of melioidosis in laboratory staff.^{56–58}

Natural Modes of Infection

Natural modes of transmission usually occur through direct contact with an environmental source (usually water or soil) by ingestion, percutaneous inoculation, or inhalation of the organism. In endemic areas, a significant number of agricultural workers have positive antibody titers to *B. pseudomallei* in the absence of overt disease.⁵⁹ Manifestations include localized disease, pulmonary disease, bacteremia, and disseminated disease. Abscesses can be seen in a variety of tissues and organs. However, the majority of persons exposed to this organism do not develop clinical infection.⁵⁴ Latent infection with subsequent reactivation is well recognized. Risk factors for contracting melioidosis include diabetes, liver or renal disease, chronic lung disease, thalassemia, malignancy, and immunosuppression.^{54,60,61}

Laboratory Safety and Containment Recommendations

B. pseudomallei can cause systemic disease in human patients. Infected tissues and purulent drainage from cutaneous or tissue abscesses can be sources of infection as can blood and sputum. The ability of *B. pseudomallei* to survive for years in water (as well as soil) should be a consideration in development and implementation of safety, disinfection, and containment procedures for laboratories and animal facilities handling this agent.^{62,63}

BSL-3 and ABSL-3 practices, containment equipment, and facilities are recommended for all manipulations of suspect cultures, animal necropsies, and for experimental animal studies. BSL-3 practices are recommended for preparatory work on cultures or contaminated materials for automated identification systems. BSL-3 practices, containment equipment, and facilities are appropriate for production operations. BSL-2 practices, containment equipment, and facilities are recommended for primary inoculation of cultures from potentially infectious clinical materials.

Special Issues

Be advised of possible misidentification using automated systems. For identification using MALDI-TOF MS, it is recommended to use alternative tube extraction that kills viable organisms and not direct spotting of plates in the open laboratory.

Select Agent *B. pseudomallei* is a Select Agent requiring registration with CDC and/or USDA for possession, use, storage and/or transfer.⁶⁴ See [Appendix F](#) for additional information.

Transfer of Agent Importation of this agent requires CDC and/or USDA importation permits. Domestic transport of this agent may require a permit from USDA APHIS VS. A DoC permit may be required for the export of this agent to another country. See [Appendix C](#) for additional information.

***Campylobacter* species**

Campylobacters are curved, S-shaped, or spiral Gram-negative rods associated with gastrointestinal infections, bacteremia, and sepsis. Organisms are isolated from stool specimens using selective media, reduced oxygen tension, and elevated incubation temperature (43°C) for some species, or they may be detected by molecular testing of primary clinical specimens.

Occupational Infections

These organisms rarely cause Laboratory-associated infections (LAI), although laboratory-associated cases have been documented.^{65–67} Infected animals are also a potential source of infection.⁶⁸

Natural Modes of Infection

Numerous domestic and wild animals, including poultry, pets, farm animals, laboratory animals, and wild birds, are known reservoirs and are a potential source of infection for laboratory and animal care personnel. While the infective dose is not firmly established, ingestion of as few as 350–800 organisms has caused symptomatic infection.^{69–71} Natural transmission usually occurs from ingestion of organisms in contaminated food such as poultry and milk products, contaminated water, or from direct contact with infected pets and farm animals—particularly exposure to cow manure.⁷² Person-to-person transmission has been documented.⁷³ Although the illness is usually self-limiting, relapses can occur in untreated cases and in association with some immunocompromised conditions.⁷⁴ Although infection can be mild, significant complications can occur in pregnant women, including septic abortion.^{75,76}

Laboratory Safety and Containment Recommendations

Pathogenic *Campylobacter* spp. may occur in fecal specimens in large numbers. *C. fetus* subsp. *fetus* may also be present in blood, exudates from abscesses,

tissues, and sputa. *Campylobacter* spp. can survive for many weeks in water at 4°C. The primary laboratory hazards are ingestion and parenteral inoculation of the organism. The significance of aerosol exposure is not known.

BSL-2 practices, containment equipment, and facilities are recommended for activities with cultures or potentially infectious clinical materials. ABSL-2 practices, containment equipment, and facilities are recommended for activities with naturally or experimentally infected animals.

Special Issues

Transfer of Agent Importation of this agent requires CDC and/or USDA importation permits. Domestic transport of this agent may require a permit from USDA APHIS VS. A DoC permit may be required for the export of this agent to another country. See [Appendix C](#) for additional information.

Chlamydia psittaci, C. trachomatis, C. pneumoniae

Chlamydia psittaci, *C. pneumoniae*, and *C. trachomatis* are the three species of *Chlamydia* known to infect humans. Alternative nomenclature may include the names *Chlamydophila pneumoniae* and *Chlamydophila psittaci*. Chlamydiae are non-motile, bacterial pathogens with obligate intracellular life cycles. These three species of *Chlamydia* vary in host spectrum, pathogenicity, and in the clinical spectrum of disease. *C. psittaci* is a zoonotic agent that commonly infects psittacine (i.e., parrot family) birds and is highly pathogenic for humans. With appropriate treatment, the mortality rate for *C. psittaci* is about 1%.⁷⁷⁻⁷⁹ *C. trachomatis* is historically considered an exclusively human pathogen. *C. pneumoniae* is considered the least pathogenic species, often resulting in subclinical or asymptomatic infections in both animals and humans. Chlamydiae have a biphasic life cycle: elementary bodies form the extracellular stage and are infective, while the reticulate bodies are intracellular and replicate by binary fission in vacuoles.⁷⁸⁻⁸⁰

Occupational Infections

Chlamydial infections caused by *C. psittaci* and *C. trachomatis* lymphogranuloma venereum (LGV) strains were at one time among the commonly reported laboratory-associated bacterial infections.^{36,83} In cases reported before 1955, the majority of infections were psittacosis, and these had the highest case fatality rate of laboratory-associated infectious agents.⁸⁴ The major sources of laboratory-associated psittacosis are contact with and exposure to infectious aerosols in the handling, care, or the necropsy of naturally or experimentally infected birds. Infected mice and eggs also are important sources of *C. psittaci*. Most reports of Laboratory-associated infections with *C. trachomatis* attribute the infection to inhalation of large quantities of aerosolized organisms during purification or sonification procedures. Early reports commonly attributed infections to exposure

to aerosols formed during nasal inoculation of mice or inoculation of egg yolk sacs and harvest of chlamydial elementary bodies. Infections are associated with fever, chills, malaise, and headache; a dry cough is also associated with *C. psittaci* infection. Some workers exposed to *C. trachomatis* have developed conditions including mediastinal and supraclavicular lymphadenitis, pneumonitis, conjunctivitis, and keratitis.^{81,85} Seroconversion to chlamydial antigens is common and often striking; however, early antibiotic treatment may prevent an antibody response. Antibiotics are effective against chlamydial infections. A case of Laboratory-associated infection attributed to inhalation of droplet aerosols with *C. pneumoniae* has been reported.⁸⁶ There has been a report of an outbreak attributed to exposure to equine fetal membranes.^{87,88} With all species of Chlamydia, occupational exposures that can lead to infection most often occur through exposure to mucosal tissues in the eyes, nose, and respiratory tract.

Natural Modes of Infection

C. psittaci is the cause of psittacosis, a respiratory infection that can lead to severe pneumonia requiring intensive care support and possible death. Sequelae include endocarditis, hepatitis, abortion, and neurological complications.⁷⁸ Natural infections are acquired by inhaling dried secretions from infected birds. Psittacine birds commonly kept as pets (e.g., parrots, parakeets, cockatiels) and poultry are most frequently involved in transmission. *C. trachomatis* can cause a spectrum of clinical manifestations including genital tract infections, inclusion conjunctivitis, trachoma, pneumonia in infants, and LGV. The LGV strains cause more severe and systemic disease than do genital strains. *C. trachomatis* genital tract infections are sexually transmitted and ocular infections (trachoma) are transmitted by exposure to secretions from infected persons through contact or fomite transmission. *C. pneumoniae* is a common cause of respiratory infection; up to 50% of adults have serologic evidence of previous exposure. Infections with *C. pneumoniae* are transmitted by droplet aerosolization and are most often mild or asymptomatic, although there is research on the possible association of this agent with chronic diseases such as atherosclerosis, asthma, and others.^{82,89}

Laboratory Safety and Containment Recommendations

C. psittaci may be present in the tissues, feces, nasal secretions, and blood of infected birds, and in the blood, sputum, and tissues of infected humans. *C. psittaci* can remain infectious in the environment for months and on dry, inanimate surfaces for 15 days.⁹⁰ *C. trachomatis* may be present in genital, bubo, and conjunctival fluids of infected humans. Exposure to infectious aerosols and droplets, created during the handling of infected birds and tissues, are the primary hazards to laboratory personnel working with *C. psittaci*.^{91,92} The primary laboratory hazards of *C. trachomatis* and *C. pneumoniae* are accidental parenteral inoculation and direct and indirect exposure of mucous membranes of the eyes, nose, and mouth to genital, bubo, or conjunctival fluids, cell culture

materials, and fluids from infected cell cultures or eggs. Infectious aerosols, including those that may be created as a result of centrifugation, also pose a risk for infection.

BSL-3 practices and containment equipment are recommended for activities involving work with cultures, specimens, or clinical isolates known to contain or be potentially infected with the LGV serovars (L1 through L3) of *C. trachomatis*. BSL-3 practices, containment equipment, and facilities are indicated for activities with high potential for droplet or aerosol production and for activities involving large quantities or concentrations of infectious materials.

BSL-3 practices, containment equipment, and facilities are also recommended for activities involving the necropsy of infected birds and the diagnostic examination of tissues or cultures known to contain or be potentially infected with *C. psittaci* strains of avian origin. Wetting the feathers of infected birds with a detergent-disinfectant prior to necropsy can appreciably reduce the risk of aerosols of infected feces and nasal secretions on the feathers and external surfaces of the bird. ABSL-3 practices, containment equipment, and facilities and respiratory protection are recommended for personnel working with naturally or experimentally infected caged birds.

Activities involving non-avian strains of *C. psittaci* may be performed in a BSL-2 facility as long as BSL-3 practices are followed. Laboratory work with the LGV serovars of *C. trachomatis* can be conducted in a BSL-2 facility as long as BSL-3 practices are followed when handling potentially infectious materials.

BSL-2 practices, containment equipment, and facilities are recommended for personnel working with clinical specimens and cultures or other materials known or suspected to contain the ocular or genital serovars of *C. trachomatis* or *C. pneumoniae*. ABSL-2 practices, containment equipment, and facilities are recommended for activities with animals that have been experimentally infected with genital serovars of *C. trachomatis* or *C. pneumoniae*.

Special Issues

C. trachomatis genital infections are reportable infectious diseases.

Vaccines There are no human vaccines against *Chlamydia* spp.

Transfer of Agent Importation of this agent requires CDC and/or USDA importation permits. Domestic transport of this agent may require a permit from USDA APHIS VS. A DoC permit may be required for the export of this agent to another country. See [Appendix C](#) for additional information.

***Clostridium botulinum* and neurotoxin-producing species of Clostridia**

Clostridium botulinum, and rare strains of *C. baratii* and *C. butyricum*, are anaerobic, spore-forming, Gram-positive bacilli that cause botulism, a life-threatening foodborne illness. The pathogenicity of these organisms results from the production of botulinum toxin under anaerobic conditions in which *C. botulinum* spores germinate. Please refer to Botulinum neurotoxins in [Section VIII-G](#) for biosafety guidance in handling toxin preparations.

Laboratory Safety and Containment Recommendations

Neurotoxin producing Clostridia species or its toxin may be present in a variety of food products, clinical materials (serum, feces), and environmental samples (soil, surface water) handled in the laboratory.⁹³ In addition, bacterial cultures may produce very high levels of toxin.⁹⁴ In healthy adults, it is typically the toxin and not the organism that causes disease. Risk of laboratory exposure is primarily due to the presence of the toxin, as opposed to infection from the organism that produces the toxin. Toxin exposure may occur through ingestion, contact with non-intact skin or mucosal membranes, or inhalation. Although spore-forming, there is no known risk from spore exposure except for the potential presence of residual toxin associated with pure spore preparations. It is recommended to use laboratory safety protocols that focus on the prevention of accidental exposure to the toxin produced by these Clostridia species.

BSL-3 practices and containment are recommended for activities with a high potential for aerosol or droplet production or for those requiring routine handling of larger quantities of the organism or toxin. ABSL-2 and BSL-2 practices, containment equipment, and facilities are recommended for diagnostic studies and titration of toxin. Before the collection of specimens, it is recommended to call the designated public health laboratory regarding any case of suspected botulism for guidance on diagnosis, treatment, specimen collection, and investigation.⁹⁵ BSL-2 practices, containment equipment, and facilities are recommended for activities that involve the organism or the toxin including the handling of potentially contaminated food.⁹⁶

Special Issues

Select Agent Neurotoxin-producing Clostridia species are Select Agents requiring registration with CDC and/or USDA for possession, use, storage and/or transfer. See [Appendix F](#) for additional information. See the *C. botulinum* Toxin Agent Summary Statement in [Section VIII-G](#) and [Appendix I](#) for additional information.

Transfer of Agent Importation of this agent requires CDC and/or USDA importation permits. Domestic transport of this agent may require a permit from USDA APHIS VS. A DoC permit may be required for the export of this agent or its toxin to another country. See [Appendix C](#) for additional information.

Clostridioides* (formerly *Clostridium*) *difficile

Clostridioides (formerly *Clostridium*) *difficile* is a Gram-positive, spore-forming, obligate anaerobic bacillus, and it is the most common cause of infectious diarrhea in hospitalized patients.⁹⁷ The incidence of infection in the United States has increased dramatically since 2000. There were a half a million cases and 29,000 deaths reported in the United States in 2011.⁹⁸ Increases in incidence have also been observed worldwide.⁹⁹ Clinical presentations range from asymptomatic colonization to mild self-limiting diarrhea to fulminant pseudomembranous colitis, toxic megacolon, and multi-organ failure, requiring emergency colectomy.¹⁰⁰ Because individuals may be asymptotically colonized with toxigenic or non-toxigenic strains of *C. difficile*, testing in the clinical diagnostic laboratory may involve one of several one, two, or three-step algorithms in an attempt to optimize sensitivity and specificity. Tests include enzyme immunoassays for free toxin or glutamate dehydrogenase, toxigenic culture, and nucleic acid amplification tests for toxin.¹⁰¹

Occupational Infections

There is a report of laboratory-associated *C. difficile* infection based on a clinical laboratory survey,¹⁰² but cases are rare.

Natural Modes of Infection

Transmission is primarily via the fecal-oral route through hand-to-hand contact. Airborne environmental dispersal is also a route of transmission.^{103,104} Most infections present during or shortly after a course of antimicrobial therapy, which disrupts the intestinal microbial composition, permitting *C. difficile* colonization and toxin production. Clindamycin, other macrolides, third-generation cephalosporins, penicillins, and fluoroquinolones are frequently associated with *C. difficile* infection.¹⁰⁵ Between 20–35% of patients fail initial therapy, and 60% of patients with multiple prior recurrences will fail subsequent therapy. Fecal transplantation has become a successful therapeutic option for many patients.^{106,107} Asymptomatic colonization in neonates and infants (<2 years) is quite common. There is concern for an increasing incidence in children beyond this age.¹⁰⁸ *C. difficile* virulence factors include the exotoxins TcdA and TcdB, which bind to receptors on epithelial cells. NAP1, PCR ribotype 027 is a hypervirulent strain of *Clostridioides difficile*, which also contains a binary toxin (CDT) and a deletion in the *tcdC* gene that affects the production of toxins.¹⁰⁰ It is characterized by high-level fluoroquinolone resistance, efficient sporulation, enhanced cytotoxicity, and high toxin production. There is an associated higher mortality rate, as patients are more likely to develop life-threatening complications.^{109,110} Infection or asymptomatic carriage can also occur in domestic, farm, and wild animals. *C. difficile* can be recovered from retail meats.¹⁰⁴

Laboratory Safety and Containment Recommendations

Infectious fecal specimens are the most common *C. difficile*-containing specimens received in the laboratory. Endospores of *C. difficile* are impervious to desiccation, temperature fluctuations, freezing, irradiation, and many antiseptic solutions, including alcohol-based gels and quaternary ammonium-based agents.¹⁰⁶ Spores can survive in the environment for months to years.¹⁰⁴ Guidelines are available for management of healthcare-associated infections due to *C. difficile* and for cleaning to reduce the spread of the organism.¹¹¹

BSL-2 practices, containment equipment, and facilities are recommended for all activities utilizing known or potentially infected clinical materials or cultures. ABSL-2 facilities are recommended for studies utilizing infected laboratory animals.

Special Issues

Transfer of Agent Importation of this agent requires CDC and/or USDA importation permits. Domestic transport of this agent may require a permit from USDA APHIS VS. A DoC permit may be required for the export of this agent to another country. See [Appendix C](#) for additional information.

***Clostridium tetani* and Tetanus toxin**

Clostridium tetani is an anaerobic, endospore-forming, Gram-positive rod found in the soil and is an intestinal tract commensal. It produces a potent neurotoxin, tetanospasmin, which causes tetanus, an acute neurologic condition characterized by painful muscular contractions. Tetanospasmin is an exceedingly potent protein toxin that consists of a heavy chain subunit that binds the toxin to receptors on neuronal cells and a light chain subunit that blocks the release of inhibitory neural transmitter molecules within the central nervous system. The incidence of tetanus in the United States has declined steadily since the introduction of tetanus toxoid vaccines in the 1940s.^{112,113}

Occupational Infections

Although the risk of infection to laboratory personnel is low, there have been some incidents of laboratory personnel exposure recorded.^{84,114}

Natural Modes of Infection

Contamination of wounds by soil is the usual mechanism of transmission for tetanus. Of the 233 cases of tetanus reported to CDC from 1998 through 2000, acute injury (puncture, laceration, abrasion) was the most frequent predisposing condition. Elevated incidence rates also were observed for persons aged over 60 years, diabetics, and intravenous drug users.^{112,113} When introduced into a suitable anaerobic or microaerophilic environment, *C. tetani* spores germinate

and produce tetanospasmin. The incubation period ranges from three to 21 days. The observed symptoms are primarily associated with the presence of the toxin. Wound cultures are not generally useful for diagnosing tetanus.^{95,115} Tetanus is a medical emergency and immediate treatment with human tetanus immune globulin is indicated.¹¹³

Laboratory Safety and Containment Recommendations

The organism may be found in soil, intestinal, or fecal samples. Accidental parenteral inoculation of the toxin is the primary hazard to laboratory personnel. Because it is uncertain if tetanus toxin can be absorbed through mucous membranes, the hazards associated with aerosols and droplets remain unclear.

BSL-2 practices, containment equipment, and facilities are recommended for activities involving the manipulation of cultures or toxins. ABSL-2 practices, containment equipment, and facilities are recommended for animal studies.

Special Issues

Vaccines It is recommended that vaccination status be considered in a risk assessment for work with this organism and/or toxin. While the risk of laboratory-associated tetanus is low, vaccination is recommended for some following risk assessment, and review of the current recommendations of the ACIP.¹¹⁶

Transfer of Agent Importation of this agent or its toxin may require CDC and/or USDA importation permits. Domestic transport of this agent may require a permit from USDA APHIS VS. A DoC permit may be required for the export of this agent to another country. See [Appendix C](#) for additional information.

Corynebacterium diphtheriae

Corynebacterium diphtheriae is a pleomorphic, Gram-positive rod that is isolated from the nasopharynx and skin of humans. The organism will grow on media containing 5% sheep blood, but it is recommended that primary plating include one selective agar such as cysteine-tellurite blood agar or fresh Tinsdale media incubated in 5% CO₂-enriched atmosphere to separate from normal oral flora.¹¹⁷ *C. diphtheriae* produces a potent exotoxin and is the causative agent of diphtheria, one of the most widespread bacterial diseases of the pre-vaccine era. The exotoxin gene is found on the beta-corynebacteriophage, which can infect non-toxigenic strains of *C. ulcerans* or *C. pseudotuberculosis*, leading to the production of toxin by these species.¹¹⁸

Occupational Infections

Laboratory-associated infections with *C. diphtheriae* have been documented.^{84,119} Zoonotic infections with *C. diphtheriae* have not been recorded. *C. ulcerans* is a zoonotic pathogen that has been cultured from untreated milk and companion animals and infrequently associated with toxic infections in humans.^{120,121}

Inhalation, accidental parenteral inoculation, and ingestion are the primary laboratory hazards.

Natural Modes of Infection

The agent may be present in exudates or secretions of the nose, throat (tonsil), pharynx and larynx, in wounds, blood, and on the skin. *C. diphtheriae* can be present for weeks to months in the nasopharynx and skin lesions of infected individuals and for a lifetime in asymptomatic individuals. *C. diphtheriae* can survive for up to six months on dry inanimate surfaces. Travel to endemic areas or close contact with persons who have returned recently from such areas increases risk.¹²² Transmission usually occurs via direct contact with patients or carriers, and more rarely, with articles such as clothing contaminated with secretions from infected people. Naturally occurring diphtheria is characterized by the development of grayish-white, membranous lesions involving the tonsils, pharynx, larynx, or nasal mucosa. Systemic sequelae are associated with the production of diphtheria toxin, and the toxic dose of diphtheria toxin in humans is <100 ng per kg body weight.¹²³ An effective vaccine is available for diphtheria, and this disease has become a rarity in countries with vaccination programs.

Laboratory Safety and Containment Recommendations

BSL-2 practices, containment equipment, and facilities are recommended for all activities utilizing known or potentially infected clinical materials or cultures. ABSL-2 facilities are recommended for studies utilizing infected laboratory animals.

Special Issues

Vaccines A licensed vaccine is available. The reader is advised to consult the current recommendations of the ACIP.¹²⁴ While the risk of laboratory-associated diphtheria is low, the administration of an adult diphtheria-tetanus toxoid at ten-year intervals may further reduce the risk of illness to laboratory and animal care personnel.¹²⁴

Transfer of Agent Importation of this agent requires CDC and/or USDA importation permits. A DoC permit may be required for the export of this agent to another country. See [Appendix C](#) for additional information.

Francisella tularensis

Francisella tularensis is a small, Gram-negative coccobacillus that infects numerous animal species, especially lagomorphs (including rabbits); it is the causal agent of tularemia (Rabbit fever, Deer fly fever, Ohara disease, or Francis disease) in humans. *F. tularensis* can be divided into three subspecies: *F. tularensis* (Type A), *F. holarctica* (Type B), and *F. mediasiatica*. *F. tularensis* subsp. *novicida* is now considered to be a separate species and referred to as

F. novicida. Type A and Type B strains are highly infectious, requiring only 10–50 organisms to cause disease, and are the main cause of tularemia worldwide.¹²⁵ The overall fatality rate of infections is <2%, but can be up to 24% for particular strains.¹²⁶ Person-to-person transmission of tularemia has not been documented. The incubation period varies with the virulence of the strain, dose, and route of introduction, but ranges from 1–14 days with most cases exhibiting symptoms in three to five days.¹²⁷ Symptoms include sudden fever, chills, headaches, diarrhea, muscle aches, joint pain, dry cough, and progressive weakness, with possible development of pneumonia. Other symptoms may include skin or mouth ulcers, swollen and painful lymph nodes, sore throat, and swollen, painful eyes.

Occupational Infections

Tularemia has been a commonly reported laboratory-associated bacterial infection.^{84,128} Most cases have occurred at facilities involved in tularemia research; however, cases have been reported in diagnostic laboratories as well. Occasional cases are linked to work with naturally or experimentally infected animals or their ectoparasites.

Natural Modes of Infection

Arthropod bites (e.g., tick, deer fly, horse fly, mosquito), handling or ingesting infectious animal tissues or fluids, ingestion of contaminated water or food, and inhalation of infective aerosols are the primary transmission modes in nature. Occasionally, infections have occurred from bites or scratches by carnivores with contaminated mouthparts or claws.

Laboratory Safety and Containment Recommendations

The agent may be present in lesion exudates, respiratory secretions, CSF, blood or lymph node aspirates from patients, tissues from infected animals, fluids from infected animals, and fluids from infected arthropods. Direct contact of skin or mucous membranes with infectious materials, accidental parenteral inoculation, ingestion, and exposure to aerosols and infectious droplets have resulted in infection. Infection has been more commonly associated with cultures than with clinical materials and infected animals.¹²⁸ According to the Public Health Agency of Canada's (PHAC) Pathogen Safety Data Sheet for *F. tularensis*, the agent can survive for months to years in carcasses, organs, and straw. Additional information is available at <https://www.canada.ca/en/public-health/services/laboratory-biosafety-biosecurity/pathogen-safety-data-sheets-risk-assessment/francisella-tularensis-material-safety-data-sheets-msds.html>.

BSL-3 and ABSL-3 practices, containment equipment, and facilities are recommended for all manipulations of suspect cultures, animal necropsies, and for experimental animal studies. BSL-3 practices are recommended for preparatory work prior to the use of automatic instruments that involves manipulation of

cultures. Characterized strains of reduced virulence such as LVS and SCHU S4ΔcI_pB can be handled with BSL-2 practices. *F. novicida* strains can also be handled with BSL-2 practices. BSL-2 practices, containment equipment, and facilities are recommended for initial activities involving clinical materials of human or animal origin suspected to contain *F. tularensis*.

Special Issues

Be advised of possible misidentification using automated systems. For identification of samples suspected of containing *F. tularensis* using MALDI-TOF MS, it is recommended to use alternative tube extraction that kills viable organisms and not direct spotting of plates in the open laboratory.

Vaccines A vaccine for tularemia is under review by the Food and Drug Administration and is not currently available in the United States.¹³⁰

Select Agent *F. tularensis* is a Select Agent requiring registration with CDC and/or USDA for possession, use, storage and/or transfer. See [Appendix F](#) for additional information.

Transfer of Agent Importation of this agent requires CDC and/or USDA importation permits. Domestic transport of this agent may require a permit from USDA APHIS VS. A DoC permit may be required for the export of this agent to another country. See [Appendix C](#) for additional information.

Helicobacter species

Helicobacter species are spiral or curved, Gram-negative rods isolated from gastrointestinal and hepatobiliary tracts of mammals and birds. There are currently 37 recognized species, including at least 14 isolated from humans. *Helicobacter pylori* is the main cause of peptic ulcer disease and a major risk factor for gastric cancer. The main habitat of *H. pylori* is the human gastric mucosa. Other *Helicobacter* spp. (*H. cinaedi*, *H. canadensis*, *H. canis*, *H. pullorum*, and *H. fennelliae*) may cause asymptomatic infection as well as proctitis, proctocolitis, enteritis and extraintestinal infections in humans.¹³¹ Prevalence of *H. pylori* infection is decreasing worldwide, but infection is higher in certain ethnic groups and in migrants.¹³²

Occupational Infections

Both experimental and accidental LAIs with *H. pylori* have been reported.^{133,134} Ingestion is the primary known laboratory hazard. The importance of aerosol exposures is unknown.

Natural Modes of Infection

Chronic gastritis and duodenal ulcers are associated with *H. pylori* infection. Epidemiologic associations have also been made with gastric adenocarcinoma.¹³⁵

Human infection with *H. pylori* may be long in duration with few or no symptoms or may present as an acute gastric illness. Transmission, while incompletely understood, is thought to be by the fecal-oral or oral-oral route.

Laboratory Safety and Containment Recommendations

H. pylori may be present in gastric and oral secretions and stool. The enterohepatic *Helicobacter* spp. (e.g., *H. canadensis*, *H. canis*, *H. cinaedi*, *H. fennelliae*, *H. pullorum*, and *H. winghamensis*) may be isolated from stool specimens, rectal swabs, and blood cultures.¹³¹ It is recommended to incorporate processes for containment of potential aerosols or droplets into procedures involving homogenization or vortexing of gastric specimens.¹³⁶

BSL-2 practices, containment equipment, and facilities are recommended for activities with clinical materials and cultures known to contain or potentially contain the *Helicobacter* spp. ABSL-2 practices, containment equipment, and facilities are recommended for activities with experimentally or naturally infected animals.

Special Issues

Transfer of Agent Importation of this agent requires CDC and/or USDA importation permits. Domestic transport of this agent may require a permit from USDA APHIS VS. A DoC permit may be required for the export of this agent to another country. See [Appendix C](#) for additional information.

***Legionella pneumophila* and other *Legionella* spp.**

Legionella spp. are small, faintly staining, Gram-negative bacteria. They are obligately aerobic, slow-growing, nonfermentative organisms that have a unique requirement for L-cysteine and iron salts for in vitro growth. Legionellae are readily found in natural aquatic bodies and some species (*L. longbeachae*) have been recovered from soil.^{137,138} They are able to colonize hot-water tanks at a temperature range from 40 to 50°C. There are currently 59 known *Legionella* species, three subspecies, and over 70 distinct serogroups of *Legionella*. While 30 species are known to cause human infection, the most frequent cause of human infection is *L. pneumophila* serogroup 1.¹³⁷

Occupational Infections

Although laboratory-associated cases of legionellosis have not been reported in the literature, at least one case due to presumed aerosol or droplet exposure during animal challenge studies with *L. pneumophila* has been recorded.¹³⁹ There has been one reported case of probable human-to-human transmission of *Legionella* spp.¹⁴⁰

Natural Modes of Infection

Legionella is commonly found in environmental sources, typically in man-made, warm water systems. The mode of transmission from these reservoirs is aerosolization, aspiration, or direct inoculation into the airway.¹³⁷ *Legionella* spp. may be present in amoebae from contaminated water. *Legionella* spp. have the ability to persist outside of hosts in biofilms, surviving for months in distilled water and for over a year in tap water.¹⁴¹ The spectrum of illness caused by *Legionella* species ranges from a mild, self-limited, flu-like illness (Pontiac fever) to a disseminated and often fatal disease characterized by pneumonia and respiratory failure (Legionnaires' disease). Although rare, *Legionella* has been implicated in cases of sinusitis, cellulitis, pericarditis, and endocarditis.¹³⁸ Legionellosis may be either community-acquired or nosocomial. Risk factors include smoking, chronic lung disease, and immunosuppression. Surgery, especially involving transplantation, has been implicated as a risk factor for nosocomial transmission.

Laboratory Safety and Containment Recommendations

The agent may be present in respiratory tract specimens (i.e., sputum, pleural fluid, bronchoscopy specimens, lung tissue) and in extrapulmonary sites. A potential hazard may exist for the generation of aerosols containing high concentrations of the agent.

For activities likely to produce extensive aerosols or when large quantities of *Legionella* spp. are manipulated, BSL-2 with BSL-3 practices are recommended. BSL-2 practices, containment equipment, and facilities are recommended for all activities involving materials or cultures suspected or known to contain *Legionella* spp.

ABSL-2 practices, containment equipment, and facilities are recommended for activities with experimentally-infected animals. Routine processing of environmental water samples for *Legionella* may be performed with standard BSL-2 practices.

Special Issues

Transfer of Agent Importation of this agent requires CDC and/or USDA importation permits. Domestic transport of this agent may require a permit from USDA APHIS VS. A DoC permit may be required for the export of this agent to another country. See [Appendix C](#) for additional information.

Leptospira

The genus *Leptospira* is composed of spiral-shaped bacteria with hooked ends. Leptospire are ubiquitous in nature; they are either free-living in freshwater or associated with renal infection in animals. Historically, these organisms have been classified into pathogenic (*L. interrogans*) and saprophytic (*L. biflexa*)

groups, but recent studies have identified more than 21 species based on genetic analysis, nine of which are definitive pathogens.¹⁴² These organisms also have been characterized serologically, with more than 200 pathogenic and 60 saprophytic serovars identified.¹⁴² These organisms are the cause of leptospirosis, a zoonotic disease of worldwide distribution. Growth of leptospire in the laboratory requires specialized media and culture techniques, and cases of leptospirosis are usually diagnosed by serology.

Occupational Infections

Leptospirosis is a well-documented, laboratory hazard. In older literature, 70 LAIs and ten deaths have been reported.^{36,84} Direct and indirect contact with fluids and tissues of experimentally or naturally infected mammals during handling, care, or necropsy are potential sources of infection.^{143,144} A laboratory-associated case caused by percutaneous exposure to broth cultures of *Leptospira* was reported in 2004.¹⁴⁵ It is important to remember that rodents are natural carriers of leptospire. Animals with chronic renal infection shed large numbers of leptospire in the urine continuously or intermittently for long periods of time. *Leptospira* spp. may persist for weeks in soil contaminated with infected urine. Rarely, infection may be transmitted by bites of infected animals.¹⁴³

Natural Modes of Infection

Human leptospirosis typically results from direct contact with infected animals, contaminated animal products, or contaminated water sources. Common routes of infection are abrasions, cuts in the skin or via the conjunctiva. Higher rates of infection are observed in agricultural workers and workers in other occupations associated with animal contact. Human-to-human transmission is rare. Leptospirosis can cause the following symptoms: fever, headache, chills, muscle aches, vomiting, jaundice, red eyes, abdominal pain, diarrhea, and rash. After an initial phase of illness, the patient may recover, then become ill again with another more severe phase that can involve kidney failure, liver failure, or meningitis (Weil's Disease).¹⁴⁶

Laboratory Safety and Containment Recommendations

The organism may be present in urine, blood, and tissues of infected animals and humans. Asymptomatic infection may occur in carrier animals and humans. Ingestion, parenteral inoculation, and direct and indirect contact of skin or mucous membranes, particularly the conjunctiva, with cultures or infected tissues or body fluids are the primary laboratory hazards. The importance of aerosol exposure is unclear, but occasional cases of inhalation of droplets of urine or water have been suspected.¹⁴⁷

BSL-2 practices, containment equipment, and facilities are recommended for all activities involving the use or manipulation of known or potentially infective

tissues, body fluids, and cultures. ABSL-2 practices are recommended for the housing and manipulation of infected animals.

Special Issues

Transfer of Agent Importation of this agent requires CDC and/or USDA importation permits. Domestic transport of this agent may require a permit from USDA APHIS VS. A DoC permit may be required for the export of this agent to another country. See [Appendix C](#) for additional information.

Listeria monocytogenes

Listeria monocytogenes is a Gram-positive, catalase-positive, non-spore forming, aerobic bacillus that is weakly beta-hemolytic on sheep blood agar.¹⁴⁸ The organism has been isolated from soil, animal feed (silage), and a wide range of human foods and food processing environments. It may also be isolated from symptomatic/asymptomatic animals (particularly ruminants) and humans.¹⁴⁹ This organism is the causative agent of listeriosis, a foodborne disease of humans and animals.

Occupational Infections

Cutaneous listeriosis, characterized by pustular or papular lesions on the arms and hands, has been described in veterinarians and farmers.¹⁵⁰ Asymptomatic carriage has been reported in laboratorians.¹⁵¹

Natural Modes of Infection

Most human cases of listeriosis result from eating contaminated foods, notably soft cheeses, ready-to-eat meat products (e.g., hot dogs, luncheon meats), pâté, and smoked fish/seafood.¹⁴⁹ Listeriosis can present in healthy adults with symptoms of fever and gastroenteritis; pregnant women and their fetuses; newborns; and persons with impaired immune function are at greatest risk of developing severe infections including sepsis, meningitis, and fetal demise. In pregnant women, *L. monocytogenes* infections occur most often in the third trimester and may precipitate labor. Transplacental transmission of *L. monocytogenes* poses a grave risk to the fetus.¹⁵²

Laboratory Safety and Containment Recommendations

Listeria monocytogenes may be found in feces, CSF, and blood, as well as numerous food and environmental samples.¹⁴⁹ *L. monocytogenes* is somewhat heat-resistant, can tolerate (and replicate in) cold temperatures, can survive at low pH conditions, and can be resistant to some disinfectants such as quaternary ammonium compounds.^{153,154} Naturally or experimentally infected animals are a source of exposure to laboratory workers, animal care personnel, and other animals. While ingestion is the most common route of exposure, *Listeria* can also cause eye and skin infections following direct contact with the organism.

BSL-2 practices, containment equipment, and facilities are recommended when working with clinical specimens and cultures known or suspected to contain *Listeria*. ABSL-2 practices, containment equipment, and facilities are recommended for activities involving experimentally or naturally infected animals. Due to potential risks to the fetus, it is recommended that pregnant women be advised of the risk of exposure to *L. monocytogenes*.

Special Issues

Transfer of Agent Importation of this agent requires CDC and/or USDA importation permits. Domestic transport of this agent may require a permit from USDA APHIS VS. A DoC permit may be required for the export of this agent to another country. See [Appendix C](#) for additional information.

Mycobacterium leprae

Mycobacterium leprae is a Gram-positive bacterium and is the causative agent of leprosy, also called Hansen's disease. *M. leprae* are intracellular bacteria that cannot be cultured using laboratory medium. Bacteria can be recovered from infected tissues and propagated in laboratory animals, specifically the nine-banded armadillo. *M. lepromatosis* are related bacteria that have now been identified to cause similar disease.¹⁵⁵

Occupational Infections

There are no cases of occupational acquisition of *M. leprae* reported as a result of working in a laboratory or being in contact with clinical materials of human or animal origin.

Natural Modes of Infection

Leprosy is transmitted from person-to-person following prolonged exposure, presumably via contact with respiratory secretions from infected individuals or animals. Naturally-occurring leprosy has been reported in armadillos, with both humans and armadillos recognized as reservoirs for infection.^{156,157} Although transmission from armadillos to humans has not been definitively proven, it is likely since contact with armadillos is a significant risk factor for acquisition of human disease.^{158,159} Cases in the United States have recently been seen in Texas, Florida, and Louisiana.^{160,161} Endemic animal forms of the disease have been described due to related organisms.¹⁶²

Laboratory Safety and Containment Recommendations

M. leprae may be present in tissues and exudates from lesions of infected humans and experimentally or naturally infected animals. Direct contact of the skin and mucous membranes with infectious materials and parenteral inoculation are the primary potential laboratory hazards associated with handling infectious clinical materials.

Selection of an appropriate disinfectant is an important consideration for laboratories working with mycobacteria. See [Appendix B](#) for additional information.

BSL-2 practices, containment equipment, and facilities are recommended for all activities with known or potentially infectious materials from humans and animals. It is recommended to use extraordinary care to avoid accidental parenteral inoculation with contaminated sharp instruments. ABSL-2 practices, containment equipment, and facilities are recommended for animal studies utilizing rodents, armadillos, and NHPs.

Special Issues

Transfer of Agent Importation of this agent requires CDC and/or USDA importation permits. Domestic transport of this agent may require a permit from USDA APHIS VS. A DoC permit may be required for the export of this agent to another country. See [Appendix C](#) for additional information.

***Mycobacterium tuberculosis* complex**

The *Mycobacterium tuberculosis* complex includes the species *M. tuberculosis*, *M. bovis*, *M. africanum*, *M. caprae*, *M. microti*, *M. canettii*, *M. pinnipedii*, and the recently described species *M. mungi* and *M. orygis*.^{163,164} *M. tuberculosis* grows slowly, typically requiring several weeks for formation of colonies on solid media. Incubation in broth culture can at times reduce the incubation time to less than one week if the inoculum is sufficient.¹⁶³ The organism has a thick, lipid-rich cell wall that renders bacilli resistant to harsh treatments including alkali and detergents. Mycolic acid in the cell wall results in a positive acid-fast stain.

Occupational Infections

M. tuberculosis and *M. bovis* infections are a proven hazard to laboratory personnel and others who may be exposed to infectious aerosols in the laboratory, autopsy rooms, and other healthcare facilities.^{36,84,165–169} The incidence of tuberculosis in health care personnel working with *M. tuberculosis*-infected patients has been reported to be significantly higher than that of those not working with the agent.¹⁷⁰ Multidrug-resistant (MDR) and extensively drug-resistant (XDR) strains are of particular concern.^{109,171} Naturally or experimentally infected NHPs are a proven source of human infection.¹⁷² Experimentally-infected guinea pigs and mice do not pose the same hazard because droplet nuclei are not produced by coughing in these species; however, litter from infected animal cages may become contaminated and serve as a source of infectious aerosols.

Natural Modes of Infection

M. tuberculosis is the etiologic agent of tuberculosis, a leading cause of morbidity and mortality worldwide. Infectious aerosols produced by coughing spread disease from person to person. Some individuals will develop active disease

within months of infection, and some of those will clear the infection completely. Others will achieve immunological control with latent (but viable) organisms, with potential for reactivation later upon immunosuppression. Approximately 5–10% of latent infections progress to active infections. The primary focus of infection is the lungs, but extra-pulmonary disease does occur, primarily in immunocompromised individuals. Miliary (disseminated) tuberculosis has the most serious consequences with meningitis developing in 50% of cases, along with a high fatality rate if not treated effectively. HIV infection is a serious risk factor for the development of active disease. *M. bovis* is primarily found in animals but can also infect humans. It is spread to humans, primarily children, by consumption of non-pasteurized milk and dairy products, by handling of infected carcasses, or by inhalation. Human-to-human transmission of *M. bovis* via aerosols is possible.

Laboratory Safety and Containment Recommendations

Tubercle bacilli may be present in sputum, gastric lavage fluids, CSF, urine, and in a variety of tissues. Exposure to laboratory-generated aerosols is the most important laboratory hazard encountered. Tubercle bacilli may survive in heat-fixed smears and, if present, may be aerosolized in the preparation of frozen tissue sections.¹⁷¹ Because of the low infective dose of *M. tuberculosis* (<10 bacilli), it is recommended that sputa and other clinical specimens from suspected or known cases of tuberculosis be considered potentially infectious and handled with appropriate precautions. Mycobacteria can be resistant to disinfection and may survive on inanimate surfaces for long periods. Needlesticks are also a recognized hazard. Selection of an appropriate disinfectant is an important consideration for laboratories working with mycobacteria. See [Appendix B](#) for additional information.

BSL-3 practices, containment equipment, and facilities are recommended for laboratory activities in the propagation and manipulation of cultures of any of the subspecies of the *M. tuberculosis* complex. Use of a slide-warming tray, rather than a flame, is recommended for fixation of slides. ABSL-3 practices are recommended for animal studies using experimentally or naturally infected NHPs or immunocompromised mice, as high titers may be found in organs from immunocompromised animals. Animal studies using rodents (e.g., guinea pigs, rats, rabbits, mice) can be conducted at ABSL-2 with ABSL-3 practices.¹⁷⁴ All airborne infections of rodents using *M. tuberculosis* must be performed in an appropriate ABSL-3 laboratory.

BSL-2 practices and procedures, containment equipment, and facilities are recommended for non-aerosol-producing manipulations of clinical specimens. Manipulation of small quantities of the attenuated vaccine strain *M. bovis* Bacillus Calmette-Guérin (BCG) can be performed at BSL-2 in laboratories that do not

culture *M. tuberculosis* and do not have BSL-3 facilities. However, considerable care is suggested to verify the identity of the strain and to ensure that cultures are not contaminated with virulent *M. tuberculosis* or other *M. bovis* strains.

Special Issues

Be advised of possible misidentification using automated systems. For identification using MALDI-TOF MS, it is recommended to use alternative tube extraction that kills viable organisms in the BSC, and not direct spotting of plates in the open laboratory.

Surveillance Annual or semi-annual skin testing with purified protein derivative (PPD) or FDA-approved Interferon-Gamma Release Assay (IGRA) of previously skin-test-negative personnel can be used as a surveillance procedure.¹⁷⁵

Vaccines The attenuated live BCG is available and used in other countries but is not generally recommended for use in the United States.

Transfer of Agent Importation of this agent requires CDC and/or USDA importation permits. Domestic transport of this agent may require a permit from USDA APHIS VS. A DoC permit may be required for the export of this agent to another country. See [Appendix C](#) for additional information.

Mycobacterium* spp. other than *M. tuberculosis* complex and *M. leprae

There are over 150 *Mycobacterium* species including both slowly and rapidly growing species.¹⁶³ In the past, mycobacterial isolates that were not identified as *M. tuberculosis* complex were often called atypical mycobacteria, but these are now more commonly referred to as nontuberculous mycobacteria (NTM) or mycobacteria other than tuberculosis (MOTT). The majority of mycobacterial species are common environmental organisms. There has been a perceived increase in NTM isolated from hospitalized patients over the past 20 years.^{176,177} Approximately 25 species are associated with human infections, with a number of additional species associated with infections in immunocompromised persons.¹⁷⁸ All of these species are considered opportunistic pathogens in humans, and they are not considered generally communicable; however, there is evidence of transmission between some individuals with chronic diseases.¹⁷⁹ The most common types of infections and causes are:

1. Pulmonary disease with a clinical presentation resembling tuberculosis caused by *M. kansasii*, *M. avium*, and *M. intracellulare*;
2. Lymphadenitis associated with *M. avium*, *M. scrofulaceum*, and other rapidly growing mycobacteria;¹⁸⁰
3. Disseminated infections in immunocompromised individuals caused by *M. avium* and *M. intracellulare*;

4. Pulmonary infection or colonization of patients with cystic fibrosis caused by *M. avium* complex, *M. kansasii*, *M. abscessus*, and other rapidly growing mycobacteria;^{181,182} and
5. Skin ulcers and soft tissue wound infections including Buruli ulcer caused by *M. ulcerans*, granulomas caused by *M. marinum* associated with exposure to organisms in freshwater and saltwater and fish tanks, and tissue infections resulting from trauma or surgical procedures caused by *M. fortuitum*, *M. chelonae*, and *M. abscessus*.

Occupational Infections

A Laboratory-associated infection with *Mycobacterium* spp. other than *M. tuberculosis* complex was reported when a laboratory worker injected bacteria into his thumb while performing experiments on mice.¹⁸³

Natural Modes of Infection

Person-to-person transmission is not considered common, but there is evidence for transmission in some populations.¹⁷⁹ Presumably, pulmonary infections are most often the result of inhalation of aerosolized bacilli, most likely from the surface of contaminated water. Mycobacteria are widely distributed in the environment and in animals, and zoonoses have occurred.^{184,185} They are also common in potable water supplies, perhaps as the result of the formation of biofilms.

Laboratory Safety and Containment Recommendations

Various species of mycobacteria may be present in sputa, exudates from lesions, tissues, and in environmental samples. Mycobacteria can be resistant to disinfection and survive on inanimate surfaces and for long periods in natural and tap water sources. Direct contact of skin or mucous membranes with infectious materials, ingestion, and parenteral inoculation are the primary laboratory hazards associated with clinical materials and cultures. Aerosols created during the manipulation of broth cultures or tissue homogenates of these organisms also pose a potential infection hazard.

BSL-2 practices, containment equipment, and facilities are recommended for activities with clinical materials and cultures of *Mycobacterium* other than *M. tuberculosis* complex. Clinical specimens may also contain *M. tuberculosis* and laboratory workers are advised to exercise caution to ensure the correct identification of mycobacterial isolates. Special caution is recommended in handling *M. ulcerans* and *M. marinum* to avoid skin exposure. ABSL-2 practices, containment equipment, and facilities are recommended for animal studies. Selection of an appropriate tuberculocidal disinfectant is an important consideration for laboratories working with mycobacteria. See [Appendix B](#) for additional information.

Special Issues

Transfer of Agent Importation of this agent requires CDC and/or USDA importation permits. Domestic transport of this agent may require a permit from USDA APHIS VS. A DoC permit may be required for the export of this agent to another country. See [Appendix C](#) for additional information.

Neisseria gonorrhoeae

Neisseria gonorrhoeae is a Gram-negative, oxidase-positive diplococcus associated with gonorrhea, a sexually transmitted disease of humans. The organism may be isolated from clinical specimens and cultivated in the laboratory using specialized growth media.¹⁸⁶ Infection is often diagnosed using molecular methods on direct clinical specimens.

Occupational Infections

Laboratory-associated gonococcal infections have been reported in the United States and elsewhere.^{187–189} These infections have presented as conjunctivitis, with either direct finger-to-eye contact or exposure to splashes of either liquid cultures or contaminated solutions proposed as the most likely means of transmission.

Natural Modes of Infection

Gonorrhea is a sexually transmitted disease of worldwide importance. The 2016 rate of reported infection for this disease in the United States was 145.8 per 100,000 population, a steady increase from a low of 98.1 infections per 100,000 population recorded in 2009.¹⁹¹ The natural mode of infection is through direct contact with exudates from mucous membranes of infected individuals. This usually occurs by sexual activity, although newborns may also become infected during birth.¹⁸⁶

Laboratory Safety and Containment Recommendations

The agent may be present in conjunctival, urethral and cervical exudates, synovial fluid, urine, feces, blood, and CSF. Parenteral inoculation and direct or indirect contact of mucous membranes with infectious clinical materials are known primary laboratory hazards. Laboratory-associated illness due to aerosol transmission has not been documented.

Additional primary containment and personnel precautions such as those described for BSL-3 may be indicated when there is high risk of aerosol or droplet production and for activities involving production quantities or high concentrations of infectious materials. BSL-2 practices, containment equipment, and facilities are recommended for all activities involving the use or manipulation of clinical materials or cultures. Animal studies may be performed at ABSL-2.

Special Issues

Neisseria gonorrhoeae has gained resistance to several classes of antimicrobials over the last few decades, making the organism increasingly difficult to treat. Fluoroquinolones, oral cephalosporins such as cefixime, and doxycycline are no longer recommended for treatment of uncomplicated gonorrhea. An extensively drug-resistant (XDR) strain has been reported and is being monitored, and currently, there are no other effective treatments for XDR gonorrhea.¹⁹²

Transfer of Agent Importation of this agent requires CDC and/or USDA importation permits. Domestic transport of this agent may require a permit from USDA APHIS VS. A DoC permit may be required for the export of this agent to another country. See [Appendix C](#) for additional information.

Neisseria meningitidis

Neisseria meningitidis is a Gram-negative diplococcus which can cause serious invasive bacterial infections, with clinical manifestations including serious acute meningitis and septicemia in humans. Virulence is associated with the expression of a polysaccharide capsule. Among the thirteen defined *N. meningitidis* capsular serogroups, six are the main causes of invasive meningococcal disease (serogroups A, B, C, W, X and Y). The handling of *N. meningitidis* isolates, particularly from sterile body sites, and/or clinical specimens containing live *N. meningitidis* may increase the risk of transmission for microbiologists.¹⁹³

Occupational Infections

Manipulating suspensions of *N. meningitidis* outside a BSC is associated with a high risk for contracting meningococcal disease.^{193,194} Microbiologists have been shown to have a much higher infection rate compared to that of the United States' general population aged 30–59 years, and a case fatality rate of 50%—substantially higher than the 12–15% associated with disease among the general population. Almost all the microbiologists identified as having an LAI had manipulated invasive *N. meningitidis* isolates on an open laboratory bench.¹⁹⁵ Rigorous protection from droplets or aerosols (including the use of a BSC) is recommended when microbiological procedures are performed on all *N. meningitidis* isolates. Although there are some molecular assays that can detect *N. meningitidis* directly in clinical specimens, cultures are still routinely performed.

Natural Modes of Infection

The human upper respiratory tract is the natural reservoir for *N. meningitidis*. Invasion of organisms from the respiratory mucosa into the circulatory system causes infection that can range in severity from subclinical to fulminant fatal disease. Transmission occurs from person-to-person and is usually mediated by direct contact with respiratory droplets from infected individuals.

Laboratory Safety and Containment Recommendations

N. meningitidis may be present in pharyngeal exudates, CSF, blood, saliva, sterile body sites (most commonly CSF and blood), and in rare cases, urine or urethral (genital) discharge. Parenteral inoculation, droplet exposure of mucous membranes, infectious aerosol generation and ingestion are the primary hazards to laboratory personnel. Based on the mechanism of natural infection and the risk associated with the handling of isolates on an open laboratory bench, exposure to droplets or aerosols of *N. meningitidis* is the most likely risk for infection in the laboratory. Although *N. meningitidis* does not survive well outside of a host, the organism is able to survive on plastic and glass from hours to days at room temperature.

BSL-3 practices and procedures are indicated for activities with a high potential for droplet or aerosol production and for activities involving production quantities or high concentrations of infectious materials. BSL-2 practices, containment equipment, and facilities are recommended for handling bacterial cultures and inoculation of clinical materials. It is recommended to handle all *N. meningitidis* cultures within a BSC. ABSL-2 conditions are recommended for animal studies.

Special Issues

Vaccines For protection against *N. meningitidis* serogroups A, C, Y, and W-135, there are commercially available polysaccharide and conjugate vaccines. These are recommended to be administered to otherwise healthy children in adolescence with a booster in late adolescence.¹⁹³ Recently, a meningococcal serogroup B vaccine has become available. Both vaccines are necessary for full protection as one does not confer immunity for the other.¹⁹⁶ Vaccination with both vaccines is recommended for laboratorians who handle live bacteria and may be exposed to *N. meningitidis*.^{193,197,198}

Transfer of Agent Importation of this agent requires CDC and/or USDA importation permits. Domestic transport of this agent may require a permit from USDA APHIS VS. A DoC permit may be required for the export of this agent to another country. See [Appendix C](#) for additional information.

Salmonella serotypes, other than *S. enterica* serotype Typhi (*S. Typhi*)

Salmonellae are Gram-negative, enteric bacteria associated with diarrheal illness in humans. They are motile oxidase-negative organisms that are easily cultivated on standard bacteriologic media, although enrichment and selective media may be required for isolation from clinical specimens. *Salmonellae* can easily be isolated using selective and differential media or may be detected by molecular testing of primary clinical specimens. Taxonomic studies have organized this genus into two species, *S. enterica* and *S. bongori*, containing more than 2,500 antigenically distinct serotypes.^{199,200} *S. enterica* contains the vast majority of

serotypes associated with human disease. *S. enterica* serotypes Typhimurium and Enteritidis are the serotypes most frequently encountered in the United States. This summary statement covers all serotypes except *S. Typhi*.

Occupational Infections

Salmonellosis is a documented hazard to laboratory personnel.^{114,201–204} Primary reservoir hosts include a broad-spectrum of domestic and wild animals, including birds, mammals, and reptiles, all of which may serve as a source of infection to laboratory personnel. Case reports of LAIs indicate a presentation of symptoms similar to those of naturally-acquired infections.²⁰⁵

Natural Modes of Infection

Salmonellosis is a foodborne disease of worldwide distribution. An estimated one million foodborne cases of salmonellosis occur annually in the United States, and the global burden of non-typhoidal disease is estimated to be 94 million cases and 155,000 deaths annually.^{206–208} A wide range of domestic and feral animals (e.g., poultry, swine, rodents, cattle, iguanas, turtles, chicks, dogs, cats, and others) may serve as reservoirs for this disease, as well as humans.^{209,210} Some human carriers shed the bacteria for years and some patients recovering from *S. enterica* infections may shed the bacteria for months. Animals can also have a latent or carrier state with long-term shedding of the bacteria. The most common mode of transmission is by ingestion of food from contaminated animals or contamination during processing. The disease usually presents as acute enterocolitis (fever, severe diarrhea, abdominal cramping), with an incubation period ranging from six to 72 hours, most often lasting four to seven days and patients tend to recover without treatment. Antimicrobial therapy is not recommended for uncomplicated *Salmonella*-related gastroenteritis.²⁰⁶ Bacteremia occurs in 3–10% of individuals infected with *S. enterica*. Antimicrobial resistance of *Salmonella* spp. is becoming a problem worldwide, and this is a concern for invasive disease.²¹¹

Laboratory Safety and Containment Recommendations

The agent may be present in feces, blood, urine, food, feed, and environmental materials. Some *Salmonella* spp. may survive for long periods in food, feces, water, and on surfaces. Ingestion and parenteral inoculations are the primary laboratory hazards. Naturally or experimentally infected animals are a potential source of infection for laboratory and animal care personnel and for other animals.

BSL-2 practices, containment equipment, and facilities are recommended for activities using clinical materials and diagnostic quantities of infectious cultures. It is recommended that special emphasis be placed on personal protective equipment, handwashing, manipulation of faucet handles, and decontamination of work surfaces to decrease the risk of LAI. For work involving production quantities or high concentrations of cultures, and for activities with a high potential for

aerosol production, it is recommended that a BSC be used and that centrifugation be performed using autoclavable, aerosol-tight rotors and safety cups. ABSL-2 facilities and practices are recommended for activities with experimentally infected animals.¹⁹⁹

Special Issues

Vaccines Human vaccines against non-typhoidal strains are not available.²¹²

Transfer of Agent Importation of this agent requires CDC and/or USDA importation permits. Domestic transport of this agent may require a permit from USDA APHIS VS. A DoC permit may be required for the export of this agent to another country. See [Appendix C](#) for additional information.

Salmonella enterica serotype Typhi (S. Typhi)

The genus *Salmonella* is divided into two species, *S. enterica* and *S. bongori*, containing more than 2,500 antigenically distinct subtypes or serotypes.²⁰⁰

S. enterica contains the vast majority of serotypes associated with human disease. *S. enterica* serotype Typhi, commonly designated *S. Typhi*, is the causative agent of typhoid fever. Untreated case mortality for typhoid fever is >10%.²¹³ *S. Typhi* is a motile, Gram-negative, enteric bacterium that is easily cultivated on standard bacteriologic media, although enrichment and selective media may be required for isolation of this organism from clinical materials. *S. Typhi* can easily be isolated using selective and differential media, or it may be detected by molecular testing of primary clinical specimens. *S. enterica* serotype Paratyphi (*S. Paratyphi*) is also considered a typhoidal serovar causing a similar illness.

Occupational Infections

Typhoid fever is a demonstrated hazard to laboratory personnel and students working with *S. Typhi* in teaching laboratories with many Laboratory-associated infections and several resulting fatalities being reported.^{84,114,203} Ingestion and, less frequently, parenteral inoculation are the most significant modes of transmission in the laboratory. Secondary transmission to other individuals outside of the laboratory is also a concern. Laboratory-associated *S. Typhi* infections usually present with headache, abdominal pain, high fever, and possible septicemia.²⁰³

Natural Modes of Infection

Typhoid fever is a serious, potentially lethal, bloodstream infection associated with sustained high fever and headaches. It is common in the developing world with 25 million infections and >200,000 deaths annually but rare in the United States with only 400 cases annually.^{214–216} Less than 1% of cases in the U.S. are lethal, and these cases are often associated with foreign travel. Humans are the sole reservoir, and asymptomatic carriers may occur. The infectious dose is low

(<1000 organisms), and the incubation period may vary from one to six weeks depending upon the dose of the organism. The natural mode of transmission is by ingestion of food or water contaminated by feces or urine of patients or asymptomatic carriers.^{199,206} Antimicrobial resistance of *S. Typhi* is a significant global concern.²¹⁷

Laboratory Safety and Containment Recommendations

The agent may be present in feces, blood, bile, and urine. Humans are the only known natural reservoir of infection. Ingestion and parenteral inoculation of the organism represent the primary laboratory hazards. The importance of aerosol exposure in previous cases is not known. To avoid possible secondary transmission related to contaminated surfaces and clothing in teaching laboratories, the use of nonpathogenic strains is recommended.

BSL-3 practices and equipment are recommended for activities likely to produce significant aerosols or for activities involving production quantities of organisms. BSL-2 practices, containment equipment, and facilities are recommended for activities using clinical materials and diagnostic quantities of infectious cultures. It is recommended that special emphasis be placed on personal protective equipment, handwashing, manipulation of faucet handles, and decontamination of work surfaces to decrease the risk of LAI.

It is recommended that centrifugation be performed using autoclavable aerosol-tight rotors or safety cups. ABSL-2 facilities, practices, and equipment are recommended for activities with experimentally infected animals.

Special Issues

Vaccines Vaccines for *S. Typhi* are available and it is recommended that personnel regularly working with potentially infectious materials consider vaccination. The reader is advised to consult the current recommendations of the Advisory Committee on Immunization Practices (ACIP).²¹⁸

Transfer of Agent Importation of this agent requires CDC and/or USDA importation permits. Domestic transport of this agent may require a permit from USDA APHIS VS. A DoC permit may be required for the export of this agent to another country. See [Appendix C](#) for additional information.

Shiga toxin (Verocytotoxin)-producing *Escherichia coli*

Escherichia coli (*E. coli*) is one of six species in the Gram-negative genus *Escherichia*. This organism is a common inhabitant of the bowel flora of healthy humans and other mammals and is one of the most extensively studied prokaryotes. An extensive serotyping system has been developed for *E. coli* based on the O (somatic) and H (flagellar) antigens expressed by these organisms. Certain

pathogenic clones of *E. coli* may cause urinary tract infections, bacteremia, meningitis, and diarrheal disease in humans, and these clones are associated with specific serotypes.¹⁹⁹

The diarrheagenic *E. coli* strains have been characterized into at least five basic pathogenicity groups: Shiga toxin (Verocytotoxin)-producing *E. coli* (a subset are referred to as enterohemorrhagic *E. coli*), enterotoxigenic *E. coli*, enteropathogenic *E. coli*, enteroinvasive *E. coli*, and enteroaggregative *E. coli*.¹⁹⁹ In addition to clinical significance, *E. coli* strains are routinely used as hosts for cloning experiments and other genetic manipulations in the laboratory. This summary statement only provides recommendations for safe manipulation of Shiga toxin-producing *E. coli* strains.

Occupational Infections

Shiga toxin-producing *E. coli* strains, including strains of serotype O157:H7, are a demonstrated hazard to laboratory personnel with the majority of reported Laboratory-associated infections being caused by enterohemorrhagic *E. coli*.^{219–223} Sources of infection include ingestion from contaminated hands and contact with infected animals. The infectious dose is estimated to be low, similar to that reported for *Shigella* spp., at 10–100 organisms.²²³

Natural Modes of Infection

Cattle represent the most common natural reservoir of Shiga toxin-producing *E. coli*, but it has also been detected in wild birds and rodents in close proximity to farms.²²⁴ Transmission usually occurs by ingestion of contaminated food, including raw milk, fruits, vegetables, and particularly ground beef. Human-to-human transmission has been observed in families, daycare centers, and custodial institutions. Waterborne transmission has been reported from outbreaks associated with swimming in a crowded lake and drinking unchlorinated municipal water.^{225–227} *E. coli* has the ability to survive from hours to months on inanimate surfaces. In a small number of patients (usually children) infected with these organisms, the disease progresses to hemolytic uremic syndrome or death.

Laboratory Safety and Containment Recommendations

Shiga toxin-producing *E. coli* are usually isolated from feces. However, a variety of food specimens contaminated with the organisms including uncooked ground beef, unpasteurized dairy products, and contaminated produce may present laboratory hazards. This agent may also be found in blood or urine specimens from infected humans or animals. Ingestion is the primary laboratory hazard. The importance of aerosol exposure is not known.

BSL-2 practices, containment equipment, and facilities are recommended for activities using clinical materials and diagnostic quantities of infectious cultures.

It is recommended that special emphasis be placed on personal protective equipment, handwashing, manipulation of faucet handles, and decontamination of work surfaces to decrease the risk of LAI. For work involving production quantities or high concentrations of cultures, and for activities with a high potential for aerosol production, it is recommended that a BSC be used and that centrifugation be performed using autoclavable aerosol-tight rotors and safety cups. ABSL-2 facilities and practices are recommended for activities with experimentally infected animals.

Special Issues

Transfer of Agent Importation of this agent requires CDC and/or USDA importation permits. Domestic transport of this agent may require a permit from USDA APHIS VS. A DoC permit may be required for the export of this agent to another country. See [Appendix C](#) for additional information.

Shigella

The genus *Shigella* is composed of non-motile, Gram-negative bacteria in the family *Enterobacteriaceae*. There are four subgroups that have been historically treated as separate species including: subgroup A (*Shigella dysenteriae*), subgroup B (*S. flexneri*), subgroup C (*S. boydii*), and subgroup D (*S. sonnei*). Members of the genus *Shigella* have been recognized since the late 19th century as causative agents of bacillary dysentery, or shigellosis.¹⁹⁹ *Shigella* can easily be isolated using selective and differential media, or it may be detected by molecular testing of primary clinical specimens.

Occupational Infections

Shigellosis is one of the most frequently reported Laboratory-associated infections in the United States.^{102,114} A survey of 397 laboratories in the United Kingdom revealed that in 1994–1995, four of nine reported Laboratory-associated infections were caused by *Shigella*.²²⁸ The direct handling of isolates and animal work, such as experimentally infecting guinea pigs, other rodents, and NHPs are proven sources of Laboratory-associated infection.^{114,229}

Natural Modes of Infection

Humans and other large primates are the only natural reservoirs of *Shigella* bacteria. Most transmission is by the fecal-oral route; infection also is caused by ingestion of contaminated food or water.¹⁹⁹ Infection with *Shigella dysenteriae* type 1 causes more severe, prolonged, and frequently fatal illness than does infection with other *Shigella* spp., with a fatality rate up to 20%. Complications of shigellosis can include hemolytic uremic syndrome and reactive arthritis (Reiter's syndrome).²³⁰

Laboratory Safety and Containment Recommendations

The agent may be present in feces and, rarely, in the blood of infected humans or animals. The organism can be shed for weeks after infection and it is communicable as long as the organism is present in the feces. *Shigella* spp. can survive for days in feces and water. Ingestion is the primary laboratory hazard and to a lesser extent, parenteral inoculation of the agent and person-to-person transmission are potential laboratory hazards. Although rare, experimentally-infected guinea pigs and other rodents can transmit infection to laboratory staff. The 50% infectious dose (oral) of *Shigella* for humans is only 180 organisms.¹¹⁴ The importance of aerosol exposure is not known.

BSL-2 practices, containment equipment, and facilities are recommended for activities using clinical materials and diagnostic quantities of infectious cultures. It is recommended that special emphasis be placed on personal protective equipment, handwashing, manipulation of faucet handles, and decontamination of work surfaces to decrease the risk of LAI. For work involving production quantities or high concentrations of cultures, and for activities with a high potential for aerosol production, it is recommended that a BSC be used and that centrifugation be performed using autoclavable, aerosol-tight rotors and safety cups. ABSL-2 facilities and practices are recommended for activities with experimentally-infected animals.

Special Issues

Vaccines Vaccines are currently not available for use in humans.

Transfer of Agent Importation of this agent requires CDC and/or USDA importation permits. Domestic transport of this agent may require a permit from USDA APHIS VS. A DoC permit may be required for the export of this agent to another country. See [Appendix C](#) for additional information.

***Staphylococcus aureus* (Methicillin-Resistant, Vancomycin-Resistant, or Vancomycin-Intermediate)**

Staphylococcus aureus is a Gram-positive bacterium associated with a wide spectrum of diseases in humans, ranging from minor to severe. *S. aureus* is a catalase-positive coccus that is a non-motile, non-spore forming facultative anaerobe. *S. aureus* isolates express a coagulase factor, which differentiates them from other staphylococci that colonize humans. *S. aureus* is easily cultivated on standard and selective media, such as high mannitol salt agar. Several molecular tests are also available for testing from clinical specimens. Methicillin-resistant *S. aureus* (MRSA) is common in most areas of the world, with a resistance rate of 30% in most of North America. Vancomycin is currently the treatment of choice for MRSA.²³¹ Vancomycin-resistant *S. aureus* (VRSA) (vancomycin MIC \geq 16 $\mu\text{g/mL}$) is rare, with only 14 cases documented in the

United States, in addition to unconfirmed cases in India and Iran.²³² Vancomycin-intermediate *S. aureus* (VISA) (i.e., isolates with reduced susceptibility to vancomycin, defined as a MIC of 4–8 µg/mL) have been documented at a higher rate, but remain uncommon in most hospitals.²³³ To date, all isolates of VRSA and VISA have remained susceptible to other FDA-approved drugs.

Occupational Infections

Several cases of laboratory-associated MRSA infections have been documented.^{234–236} To date, no laboratory or occupational infections due to VISA or VRSA have been reported. Case reports of Laboratory-associated infections include nasal colonization and minor skin infections. Guidelines have been provided for investigation and control of VRSA in healthcare settings.²³⁵

Natural Modes of Infection

S. aureus (including MRSA and VISA) is part of the normal human flora, found primarily in the nares and on the skin of primarily the groin and axillae. Approximately 20% of the population is persistently colonized by *S. aureus*, and 60% are colonized intermittently.²³⁸ Animals may act as reservoirs, including livestock and companion animals.²³⁹ *S. aureus* is an opportunistic pathogen that causes a wide variety of diseases in humans. The organism is a leading cause of foodborne gastroenteritis, as a result of consumption of food contaminated with enterotoxins expressed by some strains. Skin conditions caused by *S. aureus* include cellulitis, scalded skin syndrome, furuncles, carbuncles, impetigo, and abscesses. Certain strains of *S. aureus* express toxic shock syndrome toxin-1 (TSST-1), which is responsible for toxic shock syndrome. *S. aureus* is also a common cause of surgical site infections, endocarditis, peritonitis, pneumonia, bacteremia, meningitis, osteomyelitis, and septic arthritis. Infection modes include ingestion of food containing enterotoxins and person-to-person transmission via contact with colonized health care workers to patients. Nasal colonization can lead to auto-infection.

Laboratory Safety and Containment Recommendations

The agent may be present in many human specimens and in food. Primary hazards to laboratory personnel are direct and indirect contact of broken skin or mucous membranes with cultures and contaminated laboratory surfaces, parenteral inoculation, and ingestion of contaminated materials.

BSL-2 practices, containment equipment, and facilities are recommended for all activities utilizing known or potentially infected clinical materials or cultures. ABSL-2 facilities are recommended for studies utilizing infected laboratory animals.

Special Issues

Vaccines Vaccines are currently not available for use in humans.

Transfer of Agent Importation of this agent requires CDC and/or USDA importation permits. Domestic transport of this agent may require a permit from USDA APHIS VS. A DoC permit may be required for the export of this agent to another country. See [Appendix C](#) for additional information.

Treponema pallidum

Treponema pallidum is a species of extremely fastidious spirochetes that die readily upon desiccation or exposure to atmospheric levels of oxygen and have not been cultured continuously in vitro.²⁴⁰ *T. pallidum* cells have lipid-rich outer membranes and are highly susceptible to disinfection with common alcohols (i.e., 70% isopropanol). This species contains three subspecies including *T. pallidum* subsp. *pallidum* (associated with venereal syphilis), *T. pallidum* subsp. *endemicum* (associated with endemic syphilis), and *T. pallidum* subsp. *pertenue* (associated with yaws). These organisms are obligate human pathogens.

Occupational Infections

T. pallidum is a documented hazard to laboratory personnel, but there have been no reported cases since the 1970s.^{84,241} Experimentally-infected animals are a potential source of infection. Syphilis has been transmitted to personnel working with a concentrated suspension of *T. pallidum* obtained from an experimental rabbit orchitis.²⁴² Rabbit-adapted *T. pallidum* (Nichols strain and possibly others) retains virulence for humans, and rabbits are used in both clinical and research laboratories to isolate clinical strains and model venereal syphilis, respectively.²⁴³ A murine model was recently developed to study venereal syphilis.²⁴⁴

Natural Modes of Infection

Humans are the only known natural reservoir of *T. pallidum*; though, non-human primates may be a potential reservoir.²⁴⁵ Transmission occurs via direct sexual contact (venereal syphilis), direct skin contact (yaws), or direct mucous membrane contact (endemic syphilis). Venereal syphilis is a sexually transmitted disease that occurs worldwide, whereas yaws occurs in tropical areas of Africa, South America, the Caribbean, and Indonesia. Endemic syphilis is limited to arid areas of Africa and the Middle East.²⁴⁶

Laboratory Safety and Containment Recommendations

The agent may be present in materials collected from cutaneous and mucosal lesions and in blood. *T. pallidum* has a low infectious dose (57 organisms) by injection. Parenteral inoculation and contact of mucous membranes or broken skin with infectious clinical materials are the primary hazards to laboratory personnel.

BSL-2 practices, containment equipment, and facilities are recommended for all activities involving the use or manipulation of blood or other clinical specimens from humans or infected animals. ABSL-2 practices, containment equipment, and facilities are recommended for work with infected animals.

Special Issues

Vaccines Vaccines are currently not available for use in humans.

Transfer of Agent Importation of this agent requires CDC and/or USDA importation permits. Domestic transport of this agent may require a permit from USDA APHIS VS. A DoC permit may be required for the export of this agent to another country. See [Appendix C](#) for additional information.

***Vibrio* species**

Vibrio species are straight or curved motile Gram-negative rods. Growth of *Vibrio* spp. is stimulated by sodium, and the natural habitats of these organisms are primarily aquatic environments. Though rare in the U.S., cholera is an acute intestinal infection caused by *V. cholerae* with 3–5 million cases and 100,000 deaths each year, globally.²⁴⁷ There are at least 12 different *Vibrio* spp. isolated from clinical specimens. *V. cholerae* and *V. parahaemolyticus* are common causes of human enteritis, and *V. alginolyticus* and *V. vulnificus* are common causes of extraintestinal infections including wound infections and septicemia.²⁴⁸ *Vibrio* spp. can easily be isolated using selective and differential media, or can be detected by molecular testing of primary clinical specimens.

Occupational Infections

Rare cases of bacterial enteritis due to Laboratory-associated infections with either *V. cholerae* or *V. parahaemolyticus* have been reported.^{84,249–251} Naturally- and experimentally-infected animals and shellfish are potential sources for such illnesses. No other *Vibrio* spp. have been implicated in Laboratory-associated infections.

Natural Modes of Infection

The most common natural mode of infection is the ingestion of contaminated food or water. The human oral infecting dose of *V. cholerae* in healthy, non-achlorhydric individuals is approximately 10⁶–10¹¹ colony-forming units, while that of *V. parahaemolyticus* ranges from 10⁵–10⁷ cells.^{252,253} The importance of aerosol exposure is unknown; although, it has been implicated in at least one instance.²⁵¹ The risk of infection following oral exposure is increased in persons with abnormal gastrointestinal physiology, including individuals on antacids, with achlorhydria, or with partial or complete gastrectomies. Fatal cases of septicemia may occur in individuals who are immunocompromised or have pre-existing medical conditions such as liver disease, cancer, or diabetes.

Laboratory Safety and Containment Recommendations

Pathogenic *Vibrio* spp. can be present in human fecal samples or in the meats and the exterior surfaces of marine invertebrates such as shellfish. Survival and growth of *Vibrio* spp. in water is dependent on high salinity. Other clinical specimens from which *Vibrio* spp. may be isolated include blood, arm or leg wounds, eye, ear, and gallbladder.²⁵⁰ LAIs of *V. cholerae* or *V. parahaemolyticus* have been observed in laboratory researchers after the use of syringes, decontamination of a laboratory spill, or the handling of infected animals.^{249–251} Exposure of open wounds to *Vibrio* spp. in contaminated seawater or shellfish can result in infections and septicemia.

BSL-2 practices, containment equipment, and facilities are recommended for activities with cultures or potentially infectious clinical materials. ABSL-2 practices, containment equipment, and facilities are recommended for activities with naturally or experimentally infected animals.

Special Issues

Vaccines A cholera vaccine is licensed and available in the United States. It is currently only recommended for adult travelers to areas of active cholera transmission.²⁵⁴ There are currently no human vaccines against *V. parahaemolyticus*.

Transfer of Agent Importation of this agent requires CDC and/or USDA importation permits. Domestic transport of this agent may require a permit from USDA APHIS VS. A DoC permit may be required for the export of this agent to another country. See [Appendix C](#) for additional information.

Yersinia pestis

Yersinia pestis, the causative agent of plague, is a Gram-negative bacillus frequently characterized by a “safety pin” appearance on stained preparations from specimens. The incubation period for bubonic plague ranges from two to six days while the incubation period for pneumonic plague is one to six days.

Occupational Infections

Y. pestis is a documented laboratory hazard. A number of LAIs have been reported in the United States, some of which were fatal.^{84,255} One lethal case in a laboratory researcher was due to the attenuated strain KIM D27.²⁵⁶ The condition of hereditary hemochromatosis coupled with diabetes in the researcher is believed to have contributed to the fatal course of disease. Veterinary staff and pet owners have become infected when handling domestic cats with oropharyngeal or pneumonic plague.

Natural Modes of Infection

There is a natural zoonotic cycle of *Y. pestis* between wild rodents and their fleas. Infective fleabites are the most common mode of transmission, but direct human contact with infected tissues or body fluids of animals and humans may also serve as sources of infection.

Plague has a high mortality rate if untreated (50%) and caused three major pandemics, including the Black Death of the 14th century. There are three manifestations of disease: bubonic, septicemic, and pneumonic. Bubonic plague results in tender and painful lymph nodes (buboes). Septicemic plague, which may develop directly or from untreated bubonic plague, can lead to shock and bleeding into the skin and tissues, potentially causing necrosis. Pneumonic plague results in a rapidly developing pneumonia and can be spread from person to person via respiratory droplets. Plague occurs in multiple countries of the world, with the highest incidence in Africa. Most cases in the United States occur in rural, western states. Sporadic cases in the United States average about seven cases per year. Contact with infected sylvatic rodents, such as prairie dogs and ground squirrels, has resulted in human infections.²⁵⁷

Laboratory Safety and Containment Recommendations

Y. pestis has been isolated from bubo aspirates, blood, sputum, CSF and autopsy tissues (spleen, liver, lung), depending on the clinical form and stage of the disease; feces, urine or bone marrow samples may be positive for *Y. pestis* DNA or antigen but not the organism itself. Primary hazards to laboratory personnel include direct contact with cultures and infectious materials from humans or animal hosts and inhalation of infectious aerosols or droplets generated during their manipulation. Laboratory animal studies have shown the lethal and infectious doses of *Y. pestis* to be quite low, less than 100 colony-forming units.²⁵⁸ *Y. pestis* can survive for months in human blood and tissues. Fleas may remain infective for months. It is recommended that laboratory and field personnel be counseled on methods to avoid flea bites and autoinoculation when handling potentially infected live or dead animals.

BSL-3 and ABSL-3 practices, containment equipment, and facilities are recommended for all manipulations of suspect cultures, animal necropsies, and for experimental animal studies. BSL-3 practices, containment equipment, and facilities are appropriate for production operations. Characterized strains of reduced virulence such as *Y. pestis* strain A1122 can be manipulated at BSL-2. BSL-2 practices, containment equipment, and facilities are recommended for primary inoculation of cultures from potentially infectious clinical materials.

When performing fieldwork involving animals that may have fleas, gloves and appropriate clothing should be worn to prevent contact with skin, and insect

repellent can be used to reduce the risk of flea bites. Arthropod Containment Level 3 (ACL-3) facilities and practices are recommended for all laboratory work involving infected arthropods.²⁵⁵ See [Appendix G](#) for additional information on Arthropod Containment Guidelines.

Special Issues

Be advised of possible misidentification using automated systems. For identification of samples suspected of containing *Y. pestis* using MALDI-TOF MS, it is recommended to use alternative tube extraction that kills viable organisms and not direct spotting of plates in the open laboratory.

Vaccines There are no licensed vaccines currently available in the United States.²⁵⁹ New plague vaccines are in development but are not expected to be commercially available in the immediate future.²⁰⁶

Select Agent *Y. pestis* is a Select Agent requiring registration with CDC and/or USDA for possession, use, storage and/or transfer. See [Appendix F](#) for additional information.

Transfer of Agent Importation of this agent requires CDC and/or USDA importation permits. Domestic transport of this agent may require a permit from USDA APHIS VS. A DoC permit may be required for the export of this agent to another country. See [Appendix C](#) for additional information.

References

1. Dragon DC, Rennie RP. The ecology of anthrax spores: tough but not invincible. *Can Vet J.* 1995;36(5):295–301.
2. Wright JG, Quinn CP, Shadomy S, Messonnier N. Use of anthrax vaccine in the United States: recommendations of the Advisory Committee on Immunization Practices (ACIP), 2009. *MMWR Recomm Rep.* 2010;59(RR-6):1–30.
3. World Health Organization. Anthrax in humans and animals. 4th ed. Geneva: WHO Press; 2008.
4. Inglesby TV, O'Toole T, Henderson DA, Bartlett JG, Ascher MS, Eitzen E, et al. Anthrax as a biological weapon, 2002: updated recommendations for management. *JAMA.* 2002;287(17):2236–52. Erratum in: *JAMA* 2002 Oct 16;288(15):1849.
5. Watson A, Keir D. Information on which to base assessments of risk from environments contaminated with anthrax spores. *Epidemiol Infect.* 1994;113(3):479–90.
6. Bottone EJ. *Bacillus cereus*, a volatile human pathogen. *Clin Microbiol Rev.* 2010;23(2):382–98.

7. U.S. Department of Health and Human Services [Internet]. Silver Spring (MD): U.S. Food & Drug Administration; c2018 Feb 05 [cited 2018 Oct 26]. Anthrax. Available from: <https://www.fda.gov/BiologicsBloodVaccines/Vaccines/ucm061751.htm>
8. Centers for Disease Control and Prevention. Human anthrax associated with an epizootic among livestock—North Dakota, 2000. *MMWR Morb Mortal Wkly Rep.* 2001;50(32):677–80.
9. Centers for Disease Control and Prevention. Suspected cutaneous anthrax in a laboratory worker—Texas, 2002. *MMWR Morb Mortal Wkly Rep.* 2002;51(13):279–81.
10. Griffith J, Blaney D, Shadomy S, Lehman M, Pesik N, Tostenson S, et al. Investigation of inhalation anthrax case, United States. *Emerg Infect Dis.* 2014;20(2):280–3.
11. Palmateer NE, Hope VD, Roy K, Marongiu A, White JM, Grant KA, et al. Infections with spore-forming bacteria in persons who inject drugs, 2000–2009. *Emerg Infect Dis.* 2013;19(1):29–34.
12. U.S. Department of Health and Human Services [Internet]. Washington (DC): Association of Public Health Laboratories and American Society for Microbiology; c2016 [cited 2018 Oct 26]. *Clinical and Laboratory Preparedness and Response Guide*; [332 p.]. Available from: <https://asprtracie.hhs.gov/technical-resources/resource/6102/clinical-laboratory-preparedness-and-response-guide>
13. Jernigan DB, Raghunathan PL, Bell BP, Brechner R, Bresnitz EA, Butler JC, et al. Investigation of bioterrorism-related anthrax, United States, 2001: epidemiologic findings. *Emerg Infect Dis.* 2002;8(10):1019–28.
14. Weiss S, Yitzhaki S, Shapira SC. Lessons to be Learned from Recent Biosafety Incidents in the United States. *Isr Med Assoc J.* 2015;17(5):269–73.
15. Centers for disease control and prevention. Use of Anthrax Vaccine in the United States: Recommendations of the Advisory Committee on Immunization Practices. *MMWR Morb Mortal Wkly Rep.* 2019; 68(4) 1–14.
16. Weller SA, Stokes MG, Lukaszewski RA: 2015. Observations on the Inactivation Efficacy of a MALDI-TOF MS Chemical Extraction Method on *Bacillus anthracis* Vegetative Cells and Spores. *PLoS One*, 10(12):e0143870.
17. Tracz DM, Antonation KS, Corbett CR: 2016. Verification of a Matrix-Assisted Laser Desorption Ionization-Time of Flight Mass Spectrometry Method for Diagnostic Identification of High-Consequence Bacterial Pathogens. *J Clin Microbiol*, 54(3):764–767.

18. Centers for Disease Control and Prevention. Use of anthrax vaccine in response to terrorism: supplemental recommendations of the Advisory Committee on Immunization Practices. *MMWR Morb Mortal Wkly Rep.* 2002;51(45):1024–6.
19. Greig SL. Obiltoximab: First Global Approval. *Drugs.* 2016;76(7):823–30.
20. Kaur M, Singh S, Bhatnagar R. Anthrax vaccines: present status and future prospects. *Expert Rev Vaccines.* 2013;12(8):955–70.
21. Kilgore PE, Salim AM, Zervos MJ, Schmitt HJ. Pertussis: Microbiology, Disease, Treatment, and Prevention. *Clin Microbiol Rev.* 2016;29(3):449–86.
22. Mattoo S, Cherry JD. Molecular pathogenesis, epidemiology, and clinical manifestations of respiratory infections due to *Bordetella pertussis* and other *Bordetella* subspecies. *Clin Microbiol Rev.* 2005;18(2):326–82.
23. Beall B, Cassiday PK, Sanden GN. Analysis of *Bordetella pertussis* isolates from an epidemic by pulsed-field gel electrophoresis. *J Clin Microbiol.* 1995;33(12):3083–6.
24. Burstyn DG, Baraff LJ, Peppler MS, Leake RD, St Geme J, Jr., Manclark CR. Serological response to filamentous hemagglutinin and lymphocytosis-promoting toxin of *Bordetella pertussis*. *Infect Immun.* 1983;41(3):1150–6.
25. Pinto MV, Merkel TJ. Pertussis disease and transmission and host responses: insights from the baboon model of pertussis. *J Infect.* 2017;74 Suppl 1:S114–S9.
26. Centers for Disease Control and Prevention [Internet]. Atlanta (GA): National Center for Immunization and Respiratory Diseases, Division of Bacterial Diseases; c2017 [cited 2018 Oct 26]. Pertussis (Whooping Cough). Available from: <https://www.cdc.gov/pertussis/countries/index.html>
27. Yeung KHT, Duclos P, Nelson EAS, Hutubessy RCW. An update of the global burden of pertussis in children younger than 5 years: a modelling study. *Lancet Infect Dis.* 2017;17(9):974–80.
28. Guiso N. *Bordetella pertussis* and pertussis vaccines. *Clin Infect Dis.* 2009;49(10):1565–9.
29. Ward JI, Cherry JD, Chang SJ, Partridge S, Keitel W, Edwards K, et al. *Bordetella Pertussis* infections in vaccinated and unvaccinated adolescents and adults, as assessed in a national prospective randomized Acellular Pertussis Vaccine Trial (APERT). *Clin Infect Dis.* 2006;43(2):151–7.
30. Queenan AM, Cassiday PK, Evangelista A. Pertactin-negative variants of *Bordetella pertussis* in the United States. *N Engl J Med.* 2013;368(6):583–4.
31. Centers for Disease Control and Prevention. Fatal case of unsuspected pertussis diagnosed from a blood culture—Minnesota, 2003. *MMWR Morb Mortal Wkly Rep.* 2004;53(6):131–2.

32. Janda WM, Santos E, Stevens J, Celig D, Terrile L, Schreckenberger PC. Unexpected isolation of *Bordetella pertussis* from a blood culture. *J Clin Microbiol.* 1994;32(11):2851–3.
33. Centers for Disease Control and Prevention [Internet]. Atlanta (GA): National Center for Immunization and Respiratory Diseases; c2017 [cited 2018 Oct 26]. Vaccines and Preventable Diseases. Available from: <https://www.cdc.gov/vaccines/vpd/pertussis/recs-summary.html>
34. Araj GF. Brucella. In: Jorgensen JH, Pfaller MA, Carroll KC, Funke G, Landry ML, Richter SS, Warnock DW, editors. *Manual of Clinical Microbiology*, Volume 1. 11th ed. Washington (DC): ASM Press; 2015. p. 863–72.
35. Pappas G, Akritidis N, Bosilkovski M, Tsianos E. Brucellosis. *N Engl J Med.* 2005;352(22):2325–36.
36. Miller CD, Songer JR, Sullivan JF. A twenty-five year review of laboratory-acquired human infections at the National Animal Disease Center. *Am Ind Hyg Assoc J.* 1987;48(3):271–5.
37. Olle-Goig JE, Canela-Soler J. An outbreak of *Brucella melitensis* infection by airborne transmission among laboratory workers. *Am J Public Health.* 1987;77(3):335–8.
38. Singh K. Laboratory-acquired infections. *Clin Infect Dis.* 2009;49(1):142–7.
39. Traxler RM, Lehman MW, Bosserman EA, Guerra MA, Smith TL. A literature review of laboratory-acquired brucellosis. *J Clin Microbiol.* 2013;51(9):3055–62.
40. biosafety.be [Internet]. Belgium: Belgian Biosafety Server; c2018 [cited 2018 Oct 26]. Available from: <https://www.biosafety.be/>.
41. Centers for Disease Control and Prevention. Update: potential exposures to attenuated vaccine strain *Brucella abortus* RB51 during a laboratory proficiency test—United States and Canada, 2007. *MMWR Morb Mortal Wkly Rep.* 2008;57(2):36–9.
42. Grammont-Cupillard M, Berthet-Badetti L, Dellamonica P. Brucellosis from sniffing bacteriological cultures. *Lancet.* 1996;348(9043):1733–4.
43. Huddleson IF, Munger M. A Study of an Epidemic of Brucellosis Due to *Brucella melitensis*. *Am J Public Health Nations Health.* 1940;30(8):944–54.
44. Staszkiwicz J, Lewis CM, Colville J, Zervos M, Band J. Outbreak of *Brucella melitensis* among microbiology laboratory workers in a community hospital. *J Clin Microbiol.* 1991;29(2):287–90.

45. Mense MG, Borschel RH, Wilhelmsen CL, Pitt ML, Hoover DL. Pathologic changes associated with brucellosis experimentally induced by aerosol exposure in rhesus macaques (*Macaca mulatta*). *Am J Vet Res*. 2004;65(5):644–52.
46. Pardon P, Marly J. Resistance of normal or immunized guinea pigs against a subcutaneous challenge of *Brucella abortus*. *Ann Rech Vet*. 1978;9(3):419–25.
47. Almiron MA, Roset MS, Sanjuan N. The Aggregation of *Brucella abortus* Occurs Under Microaerobic Conditions and Promotes Desiccation Tolerance and Biofilm Formation. *Open Microbiol J*. 2013;7:87–91.
48. Corbel MJ. Brucellosis: an overview. *Emerg Infect Dis*. 1997;3(2):213–21.
49. Seleem MN, Boyle SM, Sriranganathan N. Brucellosis: a re-emerging zoonosis. *Vet Microbiol*. 2010;140(3–4):392–8.
50. Van Zandt KE, Greer MT, Gelhaus HC. Glanders: an overview of infection in humans. *Orphanet J Rare Dis*. 2013;8:131.
51. Centers for Disease Control and Prevention. Laboratory-acquired human glanders—Maryland, May 2000. *MMWR Morb Mortal Wkly Rep*. 2000;49(24):532–5.
52. Srinivasan A, Kraus CN, DeShazer D, Becker PM, Dick JD, Spacek L, et al. Glanders in a military research microbiologist. *N Engl J Med*. 2001;345(4):256–8.
53. Titball RW, Burtnick MN, Bancroft GJ, Brett P. *Burkholderia pseudomallei* and *Burkholderia mallei* vaccines: Are we close to clinical trials? *Vaccine*. 2017;35(44):5981–9.
54. Lipuma JJ, Currie BJ, Peacock SJ, Vandamme PAR. *Burkholderia*, *Stenotrophomonas*, *Ralstonia*, *Cupriavidus*, *Pandoraea*, *Brevundimonas*, *Comamonas*, *Delftia*, and *Acidovorax*. In: Jorgensen JH, Pfaller MA, Carroll KC, Funke G, Landry ML, Richter SS, Warnock DW, editors. *Manual of Clinical Microbiology*, Volume 1. 11th ed. Washington (DC): ASM Press; 2015. p. 791–812.
55. Limmathurotsakul D, Golding N, Dance DA, Messina JP, Pigott DM, Moyes CL, et al. Predicted global distribution of *Burkholderia pseudomallei* and burden of melioidosis. *Nat Microbiol*. 2016;1(1).
56. Green RN, Tuffnell PG. Laboratory acquired melioidosis. *Am J Med*. 1968;44(4):599–605.
57. Peacock SJ, Schweizer HP, Dance DA, Smith TL, Gee JE, Wuthiekanun V, et al. Management of accidental laboratory exposure to *Burkholderia pseudomallei* and *B. mallei*. *Emerg Infect Dis*. 2008;14(7):e2.

58. Schlech WF 3rd, Turchik JB, Westlake RE Jr, Klein GC, Band JD, Weaver RE. Laboratory-acquired infection with *Pseudomonas pseudomallei* (melioidosis). *N Engl J Med.* 1981;305(19):1133–5.
59. Kohler C, Dunachie SJ, Muller E, Kohler A, Jenjaroen K, Teparrukkul P, et al. Rapid and Sensitive Multiplex Detection of *Burkholderia pseudomallei*-Specific Antibodies in Melioidosis Patients Based on a Protein Microarray Approach. *PLoS Negl Trop Dis.* 2016;10(7):e0004847.
60. Dance DA. Ecology of *Burkholderia pseudomallei* and the interactions between environmental *Burkholderia* spp. and human-animal hosts. *Acta Trop.* 2000;74(2–3):159–68.
61. Centers for Disease Control and Prevention [Internet]. Atlanta (GA): National Center for Emerging and Zoonotic Infectious Diseases, Division of High Consequence Pathogens and Pathology; c2012 [cited 2018 Oct 29]. Melioidosis. Available from: <https://www.cdc.gov/melioidosis/>
62. Robertson J, Levy A, Sagripanti JL, Inglis TJ. The survival of *Burkholderia pseudomallei* in liquid media. *Am J Trop Med Hyg.* 2010;82(1):88–94.
63. Shams AM, Rose LJ, Hodges L, Arduino MJ. Survival of *Burkholderia pseudomallei* on Environmental Surfaces. *Appl Environ Microbiol.* 2007;73(24):8001–4.
64. Benoit TJ, Blaney DD, Gee JE, Elrod MG, Hoffmaster AR, Doker TJ, et al. Melioidosis Cases and Selected Reports of Occupational Exposures to *Burkholderia pseudomallei*—United States, 2008–2013. *MMWR Surveill Summ.* 2015;64(5):1–9.
65. Masuda T, Isokawa T. [Biohazard in clinical laboratories in Japan]. *Kansenshogaku Zasshi.* 1991;65(2):209–15.
66. Oates JD, Hodgkin UG Jr. Laboratory-acquired *Campylobacter* enteritis. *South Med J.* 1981;74(1):83.
67. Penner JL, Hennessy JN, Mills SD, Bradbury WC. Application of serotyping and chromosomal restriction endonuclease digest analysis in investigating a laboratory-acquired case of *Campylobacter jejuni* enteritis. *J Clin Microbiol.* 1983;18(6):1427–8.
68. Saunders S, Smith K, Schott R, Dobbins G, Scheftel J. Outbreak of Campylobacteriosis Associated with Raccoon Contact at a Wildlife Rehabilitation Centre, Minnesota, 2013. *Zoonoses Public Health.* 2017;64(3):222–7.
69. Hara-Kudo Y, Takatori K. Contamination level and ingestion dose of foodborne pathogens associated with infections. *Epidemiol Infect.* 2011;139(10):1505–10.

70. Black RE, Levine MM, Clements ML, Hughes TP, Blaser MJ. Experimental *Campylobacter jejuni* infection in humans. *J Infect Dis*. 1988;157(3):472–9.
71. Robinson DA. Infective dose of *Campylobacter jejuni* in milk. *Br Med J (Clin Res Ed)*. 1981;282(6276):1584.
72. Ravel A, Hurst M, Petrica N, David J, Mutschall SK, Pintar K, et al. Source attribution of human campylobacteriosis at the point of exposure by combining comparative exposure assessment and subtype comparison based on comparative genomic fingerprinting. *PLoS One*. 2017;12(8):e0183790.
73. Marchand-Senecal X, Bekal S, Pilon PA, Sylvestre JL, Gaudreau C. *Campylobacter fetus* Cluster Among Men Who Have Sex With Men, Montreal, Quebec, Canada, 2014–2016. *Clin Infect Dis*. 2017;65(10):1751–3.
74. Kaakoush NO, Castano-Rodriguez N, Mitchell HM, Man SM. Global Epidemiology of *Campylobacter* Infection. *Clin Microbiol Rev*. 2015;28(3):687–720.
75. Skuhala T, Skerk V, Markotic A, Bukovski S, Desnica B. Septic abortion caused by *Campylobacter jejuni* bacteraemia. *J Chemother*. 2016;28(4):335–6.
76. Smith JL. *Campylobacter jejuni* infection during pregnancy: long-term consequences of associated bacteremia, Guillain-Barre syndrome, and reactive arthritis. *J Food Prot*. 2002;65(4):696–708.
77. Hogerwerf L, DE Gier B, Baan B, Van Der Hoek W. *Chlamydia psittaci* (psittacosis) as a cause of community-acquired pneumonia: a systematic review and meta-analysis. *Epidemiol Infect*. 2017;145(15):3096–105.
78. Knittler MR, Sachse K. *Chlamydia psittaci*: update on an underestimated zoonotic agent. *Pathog Dis*. 2015;73(1):1–15.
79. Petrovay F, Balla E. Two fatal cases of psittacosis caused by *Chlamydophila psittaci*. *J Med Microbiol*. 2008;57(Pt 10):1296–8.
80. Beeckman DS, Vanrompay DC. Zoonotic *Chlamydophila psittaci* infections from a clinical perspective. *Clin Microbiol Infect*. 2009;15(1):11–7.
81. Corsaro D, Greub G. Pathogenic potential of novel *Chlamydiae* and diagnostic approaches to infections due to these obligate intracellular bacteria. *Clin Microbiol Rev*. 2006;19(2):283–97.
82. Gaydos C, Essig A. Chlamydiaceae. In: Jorgensen JH, Pfaller MA, Carroll KC, Funke G, Landry ML, Richter SS, Warnock DW, editors. *Manual of Clinical Microbiology*, Volume 1. 11th ed. Washington (DC): ASM Press; 2015. p. 1106–21.

83. Van Droogenbroeck C, Beeckman DS, Verminnen K, Marien M, Nauwynck H, Boesinghe Lde T, et al. Simultaneous zoonotic transmission of *Chlamydophila psittaci* genotypes D, F and E/B to a veterinary scientist. *Vet Microbiol.* 2009;135(1–2):78–81.
84. Pike RM. Laboratory-associated infections: summary and analysis of 3921 cases. *Health Lab Sci.* 1976;13(2):105–14.
85. Bernstein DI, Hubbard T, Wenman WM, Johnson BL Jr, Holmes KK, Liebhaber H, et al. Mediastinal and supraclavicular lymphadenitis and pneumonitis due to *Chlamydia trachomatis* serovars L1 and L2. *N Engl J Med.* 1984;311(24):1543–6.
86. Hyman CL, Augenbraun MH, Roblin PM, Schachter J, Hammerschlag MR. Asymptomatic respiratory tract infection with *Chlamydia pneumoniae* TWAR. *J Clin Microbiol.* 1991;29(9):2082–3.
87. Chan J, Doyle B, Branley J, Sheppard V, Gabor M, Viney K, et al. An outbreak of psittacosis at a veterinary school demonstrating a novel source of infection. *One Health.* 2017;3:29–33.
88. Taylor KA, Durrheim D, Heller J, O'Rourke B, Hope K, Merritt T, et al. Equine chlamydiosis-An emerging infectious disease requiring a one health surveillance approach. *Zoonoses Public Health.* 2018;65(1):218–21.
89. Foster LH, Portell CA. The role of infectious agents, antibiotics, and antiviral therapy in the treatment of extranodal marginal zone lymphoma and other low-grade lymphomas. *Curr Treat Options Oncol.* 2015;16(6):28.
90. Kramer A, Schwebke I, Kampf G. How long do nosocomial pathogens persist on inanimate surfaces? A systematic review. *BMC Infect Dis.* 2006;6:130.
91. Kaleta EF, Taday EM. Avian host range of *Chlamydophila* spp. based on isolation, antigen detection and serology. *Avian Pathol.* 2003;32(5):435–61.
92. Krauss H, Weber A, Appel M, Enders B, Isenberg HD, Schiefer HG, et al. Bacterial Zoonoses. In: Krauss H, Weber A, Appel M, Enders B, Isenberg HD, Schiefer HG, et al, authors. *Zoonoses: Infectious Diseases Transmissible from Animals to Humans.* 3rd ed. Washington (DC): ASM Press; 2003. p. 173–252.
93. Smith LDS, Sugiyama H. Botulism: the organism, its toxins, the disease. 2nd ed. Barlows A, editor. Springfield (IL): Charles C. Thomas; 1988.
94. Siegel LS, Metzger JF. Toxin production by *Clostridium botulinum* type A under various fermentation conditions. *Appl Environ Microbiol.* 1979;38(4):606–11.

95. Stevens DL, Bryant AE, Carroll K. Clostridium. In: Jorgensen JH, Pfaller MA, Carroll KC, Funke G, Landry ML, Richter SS, Warnock DW, editors. Manual of Clinical Microbiology, Volume 1. 11th ed. Washington (DC): ASM Press; 2015. p. 940–66.
96. Maksymowych AB, Simpson LL. A brief guide to the safe handling of biological toxin. In: Aktories K, editor. Bacterial toxins: Tools in Cell Biology and Pharmacology. London: Chapman and Hall; 1997. p. 295–300.
97. Lawson PA, Citron DM, Tyrrell KL, Finegold SM. Reclassification of *Clostridium difficile* as *Clostridioides difficile* (Hall and O’Toole 1935) Prevot 1938. Anaerobe. 2016;40:95–9.
98. Lessa FC, Mu Y, Bamberg WM, Beldavs ZG, Dumyati GK, Dunn JR, et al. Burden of *Clostridium difficile* infection in the United States. N Engl J Med. 2015;372(9):825–34.
99. Lo Vecchio A, Zacur GM. *Clostridium difficile* infection: an update on epidemiology, risk factors, and therapeutic options. Curr Opin Gastroenterol. 2012;28(1):1–9.
100. Schaffler H, Breitruck A. *Clostridium difficile*—From Colonization to Infection. Front Microbiol. 2018;9:646.
101. Gateau C, Couturier J, Coia J, Barbut F. How to: diagnose infection caused by *Clostridium difficile*. Clin Microbiol Infect. 2018;24(5):463–8.
102. Baron EJ, Miller JM. Bacterial and fungal infections among diagnostic laboratory workers: evaluating the risks. Diagn Microbiol Infect Dis. 2008;60(3):241–6.
103. Best EL, Fawley WN, Parnell P, Wilcox MH. The potential for airborne dispersal of *Clostridium difficile* from symptomatic patients. Clin Infect Dis. 2010;50(11):1450–7.
104. Crobach MJT, Vernon JJ, Loo VG, Kong LY, Pechine S, Wilcox MH, et al. Understanding *Clostridium difficile* Colonization. Clin Microbiol Rev. 2018;31(2).
105. Leffler DA, Lamont JT. *Clostridium difficile* infection. N Engl J Med. 2015;372(16):1539–48.
106. Hopkins RJ, Wilson RB. Treatment of recurrent *Clostridium difficile* colitis: a narrative review. Gastroenterol Rep (Oxf). 2018;6(1):21–8.
107. Kelly CR, Kahn S, Kashyap P, Laine L, Rubin D, Atreja A, et al. Update on Fecal Microbiota Transplantation 2015: Indications, Methodologies, Mechanisms, and Outlook. Gastroenterology. 2015;149(1):223–37.

108. Lo Vecchio A, Lancella L, Tagliabue C, De Giacomo C, Garazzino S, Mainetti M, et al. *Clostridium difficile* infection in children: epidemiology and risk of recurrence in a low-prevalence country. *Eur J Clin Microbiol Infect Dis*. 2017;36(1):177–85.
109. U.S. Department of Health and Human Services. Antibiotic Resistance Threats in the United States, 2013. Atlanta (GA): Centers for Disease Control and Prevention; 2013. 114 p.
110. McDonald LC, Killgore GE, Thompson A, Owens RC Jr, Kazakova SV, Sambol SP, et al. An epidemic, toxin gene-variant strain of *Clostridium difficile*. *N Engl J Med*. 2005;353(23):2433–41.
111. Centers for Disease Control and Prevention [Internet]. Atlanta (GA): National Center for Emerging Zoonotic Infectious Diseases, Division of Healthcare Quality Promotion; c2015 [cited 2018 Oct 29]. *Clostridium difficile* Infection. Available from: https://www.cdc.gov/hai/organisms/cdiff/cdiff_infect.html
112. Centers for Disease Control and Prevention. Tetanus surveillance—United States, 2001–2008. *MMWR Morb Mortal Wkly Rep*. 2011;60(12):365–9.
113. Centers for Disease Control and Prevention [Internet]. Atlanta (GA): National Center for Immunization and Respiratory Diseases, Division of Bacterial Diseases; c2017 [cited 2018 Oct 30]. Tetanus. Available from: <https://www.cdc.gov/tetanus/index.html>
114. Sewell DL. Laboratory-associated infections and biosafety. *Clin Microbiol Rev*. 1995;8(3):389–405.
115. Campbell JI, Lam TM, Huynh TL, To SD, Tran TT, Nguyen VM, et al. Microbiologic characterization and antimicrobial susceptibility of *Clostridium tetani* isolated from wounds of patients with clinically diagnosed tetanus. *Am J Trop Med Hyg*. 2009;80(5):827–31.
116. Centers for Disease Control and Prevention. Updated recommendations for use of tetanus toxoid, reduced diphtheria toxoid and acellular pertussis (Tdap) vaccine from the Advisory Committee on Immunization Practices, 2010.
117. Funke G, Bernard KA. Coryneform Gram-Positive Rods. In: Jorgensen JH, Pfaller MA, Carroll KC, Funke G, Landry ML, Richter SS, Warnock DW, editors. *Manual of Clinical Microbiology*, Volume 1. 11th ed. Washington (DC): ASM Press; 2015. p. 474–503.
118. Tiwari T, Warton M. Diphtheria Toxoid. In: Plotkin SA, Orenstein WA, Offit PA, Edwards KM, authors. *Plotkin's Vaccines*. 7th ed. Philadelphia (PA): Elsevier; 2018. p. 261–75.
119. Thilo W, Kiehl W, Geiss HK. A case report of laboratory-acquired diphtheria. *Euro Surveill*. 1997;2(8):67–8.

120. Galbraith NS, Forbes P, Clifford C. Communicable disease associated with milk and dairy products in England and Wales 1951–80. *Br Med J (Clin Res Ed)*. 1982;284(6331):1761–5.
121. Hogg RA, Wessels J, Hart J, Efstratiou A, De Zoysa A, Mann G, et al. Possible zoonotic transmission of toxigenic *Corynebacterium ulcerans* from companion animals in a human case of fatal diphtheria. *Vet Rec*. 2009;165(23):691–2.
122. May ML, McDougall RJ, Robson JM. *Corynebacterium diphtheriae* and the returned tropical traveler. *J Travel Med*. 2014;21(1):39–44.
123. Gill DM. Bacterial toxins: a table of lethal amounts. *Microbiol Rev*. 1982;46(1):86–94.
124. Advisory Committee on Immunization Practices; Centers for Disease Control and Prevention (CDC). Immunization of health-care personnel: recommendations of the Advisory Committee on Immunization Practices (ACIP). *MMWR Recomm Rep*. 2011;60(RR-7):1–45.
125. Maurin M, Gyuranecz M. Tularemia: clinical aspects in Europe. *Lancet Infect Dis*. 2016;16(1):113–24.
126. Centers for Disease Control and Prevention. Tularemia—United States, 2001–2010. *MMWR Morb Mortal Wkly Rep*. 2013;62(47):963–6.
127. Eliasson H, Broman T, Forsman M, Back E. Tularemia: current epidemiology and disease management. *Infect Dis Clin North Am*. 2006;20(2):289–311, ix.
128. Wurtz N, Papa A, Hukic M, Di Caro A, Leparc-Goffart I, Leroy E, et al. Survey of laboratory-acquired infections around the world in biosafety level 3 and 4 laboratories. *Eur J Clin Microbiol Infect Dis*. 2016;35(8):1247–58.
129. Jones CL, Napier BA, Sampson TR, Llewellyn AC, Schroeder MR, Weiss DS. Subversion of host recognition and defense systems by *Francisella* spp. *Microbiol Mol Biol Rev*. 2012;76(2):383–404.
130. Centers for Disease Control and Prevention [Internet]. Atlanta (GA): National Center for Emerging and Zoonotic Infectious Diseases, Division of Vector-Borne Diseases; c2016 [cited 2018 Oct 30]. Tularemia. Available from: <https://www.cdc.gov/tularemia>
131. De Witte C, Schulz C, Smet A, Malfetheriner P, Haesebrouck F. Other *Helicobacters* and gastric microbiota. *Helicobacter*. 2016;21 Suppl 1:62–8.
132. Buruoca C, Axon A. Epidemiology of *Helicobacter pylori* infection. *Helicobacter*. 2017;22 Suppl 1.
133. Matysiak-Budnik T, Briet F, Heyman M, Megraud F. Laboratory-acquired *Helicobacter pylori* infection. *Lancet*. 1995;346(8988):1489–90.

134. Marshall BJ, Armstrong JA, McGeachie DB, Glancy RJ. Attempt to fulfil Koch's postulates for pyloric *Campylobacter*. *Med J Aust*. 1985;142(8):436–9.
135. Venerito M, Vasapolli R, Rokkas T, Delchier JC, Malfertheiner P. *Helicobacter pylori*, gastric cancer and other gastrointestinal malignancies. *Helicobacter*. 2017;22 Suppl 1.
136. Pillai DR. *Helicobacter pylori* Cultures. In: Leber AL, editor. *Clinical Microbiology Procedures Handbook*, Volume 1. 4th ed. Washington (DC): ASM Press; 2016. p. 3.8.4.1–3.8.4.5.
137. Burillo A, Pedro-Botet ML, Bouza E. Microbiology and Epidemiology of Legionnaire's Disease. *Infect Dis Clin North Am*. 2017;31(1):7–27.
138. Edelstein PH, Luck C. Legionella. In: Jorgensen JH, Pfaller MA, Carroll KC, Funke G, Landry ML, Richter SS, Warnock DW, editors. *Manual of Clinical Microbiology*, Volume 1. 11th ed. Washington (DC): ASM Press; 2015. p. 887–904.
139. Centers for Disease Control and Prevention. Unpublished data. Center for Infectious Diseases. HEW, Public Health Service. 1976.
140. Correia AM, Ferreira JS, Borges V, Nunes A, Gomes B, Capucho R, et al. Probable Person-to-Person Transmission of Legionnaires' Disease. *N Engl J Med*. 2016;374(5):497–8.
141. Schwake DO, Alum A, Abbaszadegan M. Impact of environmental factors on Legionella populations in drinking water. *Pathogens*. 2015;4(2):269–82.
142. Levett PN. *Leptospira*. In: Jorgensen JH, Pfaller MA, Carroll KC, Funke G, Landry ML, Richter SS, Warnock DW, editors. *Manual of Clinical Microbiology*, Volume 1. 11th ed. Washington (DC): ASM Press; 2016. p. 1028–36.
143. Barkin RM, Guckian JC, Glosser JW. Infection by *Leptospira ballum*: a laboratory-associated case. *South Med J*. 1974;67(2):155 passim.
144. Bolin CA, Koellner P. Human-to-human transmission of *Leptospira interrogans* by milk. *J Infect Dis*. 1988;158(1):246–7.
145. Sugunan AP, Natarajaseenivasan K, Vijayachari P, Sehgal SC. Percutaneous exposure resulting in laboratory-acquired leptospirosis—a case report. *J Med Microbiol*. 2004;53(Pt 12):1259–62.
146. Centers for Disease Control and Prevention [Internet]. Atlanta (GA): National Center for Emerging and Zoonotic Infectious Diseases, Division of High-Consequence Pathogens and Pathology; c2017 [cited 2018 Oct 30]. Leptospirosis. Available from: <https://www.cdc.gov/leptospirosis/>
147. World Health Organization [Internet]. Geneva; c2018 [cited 2018 Oct 30]. Leptospirosis. Available from: <https://www.who.int/topics/leptospirosis/en/>

148. Schuchat A, Swaminathan B, Broome CV. Epidemiology of human listeriosis. *Clin Microbiol Rev.* 1991;4(2):169–83.
149. Wellinghausen N. *Listeria* and *Erysipelothrix*. In: Jorgensen JH, Pfaller MA, Carroll KC, Funke G, Landry ML, Richter SS, Warnock DW, editors. *Manual of Clinical Microbiology*, Volume 1. 11th ed. Washington (DC): ASM Press; 2016. p. 462–73.
150. Godshall CE, Suh G, Lorber B. Cutaneous listeriosis. *J Clin Microbiol.* 2013;51(11):3591–6.
151. Ortel S. [Listeriosis during pregnancy and excretion of *Listeria* by laboratory workers (author's transl)]. *Zentralbl Bakteriol Orig A.* 1975;231(4):491–502.
152. Vazquez-Boland JA, Kryptou E, Scortti M. *Listeria* Placental Infection. *MBio.* 2017;8(3). pii: e00949–17.
153. Gandhi M, Chikindas ML. *Listeria*: A foodborne pathogen that knows how to survive. *Int J Food Microbiol.* 2007;113(1):1–15.
154. Kovacevic J, Ziegler J, Walecka-Zacharska E, Reimer A, Kitts DD, Gilmour MW. Tolerance of *Listeria monocytogenes* to Quaternary Ammonium Sanitizers Is Mediated by a Novel Efflux Pump Encoded by *emrE*. *Appl Environ Microbiol.* 2015;82(3):939–53.
155. Vera-Cabrera L, Escalante-Fuentes WG, Gomez-Flores M, Ocampo-Candiani J, Busso P, Singh P, et al. Case of diffuse lepromatous leprosy associated with “*Mycobacterium lepromatosis*”. *J Clin Microbiol.* 2011;49(12):4366–8.
156. Truman RW, Kumaresan JA, McDonough CM, Job CK, Hastings RC. Seasonal and spatial trends in the detectability of leprosy in wild armadillos. *Epidemiol Infect.* 1991;106(3):549f–60.
157. Walsh GP, Meyers WM, Binford CH. Naturally acquired leprosy in the nine-banded armadillo: a decade of experience 1975–1985. *J Leukoc Biol.* 1986;40(5):645–56.
158. Bruce S, Schroeder TL, Ellner K, Rubin H, Williams T, Wolf JE Jr. Armadillo exposure and Hansen's disease: an epidemiologic survey in southern Texas. *J Am Acad Dermatol.* 2000;43(2 Pt 1):223–8.
159. Clark BM, Murray CK, Horvath LL, Deye GA, Rasnake MS, Longfield RN. Case-control study of armadillo contact and Hansen's disease. *Am J Trop Med Hyg.* 2008;78(6):962–7.
160. Domozych R, Kim E, Hart S, Greenwald J. Increasing incidence of leprosy and transmission from armadillos in Central Florida: A case series. *JAAD Case Rep.* 2016;2(3):189–92.

161. Sharma R, Singh P, Loughry WJ, Lockhart JM, Inman WB, Duthie MS, et al. Zoonotic Leprosy in the Southeastern United States. *Emerg Infect Dis.* 2015;21(12):2127–34.
162. O'Brien CR, Malik R, Globan M, Reppas G, McCowan C, Fyfe JA. Feline leprosy due to *Candidatus 'Mycobacterium lepraefelis'*: Further clinical and molecular characterisation of eight previously reported cases and an additional 30 cases. *J Feline Med Surg.* 2017;19(9):919–32.
163. Pfyffer GE. *Mycobacterium*: General Characteristics, Laboratory Detection, and Staining Procedures. In: Richter SS, editor. *Manual of Clinical Microbiology* 11th ed. 1. Washington, DC: ASM Press; 2015. p. 536–69.
164. Esteban J, Munoz-Egea MC. *Mycobacterium bovis* and Other Uncommon Members of the *Mycobacterium tuberculosis* Complex. *Microbiol Spectr.* 2016;4(6).
165. Grist NR, Emslie J. Infections in British clinical laboratories, 1982–3. *J Clin Pathol.* 1985;38(7):721–5.
166. Muller HE. Laboratory-acquired mycobacterial infection. *Lancet.* 1988;2(8606):331.
167. Pike RM, Sulkin SE, Schulze ML. Continuing Importance of Laboratory-Acquired Infections. *Am J Public Health Nations Health.* 1965;55:190–9.
168. Belchior I, Seabra B, Duarte R. Primary inoculation skin tuberculosis by accidental needlestick. *BMJ Case Rep.* 2011;2011. pii: bcr1120103496.
169. Menzies D, Fanning A, Yuan L, FitzGerald JM, Canadian Collaborative Group in Nosocomial Transmission of Tuberculosis. Factors associated with tuberculin conversion in Canadian microbiology and pathology workers. *Am J Respir Crit Care Med.* 2003;167(4):599–602.
170. Reid DD. Incidence of tuberculosis among workers in medical laboratories. *Br Med J.* 1957;2(5035):10–4.
171. Centers for Disease Control and Prevention. Acquired multidrug-resistant tuberculosis—Buenaventura, Colombia, 1998. *MMWR Morb Mortal Wkly Rep.* 1998;47(36):759–61.
172. Kaufmann AF, Anderson DC. Tuberculosis control in nonhuman primates. In: Montali RJ, editor. *The Symposia of the National Zoological Park of Zoo Animals: Proceedings of a Symposium held at the Conservation and Research Center, National Zoological Park, Smithsonian Institution, October 6–8 1976.* Washington (DC): Smithsonian Institution Press; 1978. p. 227–34.
173. Allen BW. Survival of tubercle bacilli in heat-fixed sputum smears. *J Clin Pathol.* 1981;34(7):719–22.

174. Herman P, Fauville-Dufaux M, Breyer D, Van Vaerenbergh B, Pauwels K, Dai Do Thi C, et al. Biosafety Recommendations for the Contained Use of *Mycobacterium tuberculosis* Complex Isolates in Industrialized Countries. Scientific Institute of Public Health [Internet]. 2006 [cited 2019 May 8]:[about 17 p]. Available from: https://www.biosafety.be/sites/default/files/mtub_final_dl.pdf
175. Centers for Disease Control and Prevention [Internet]. Atlanta (GA): Division of Tuberculosis Elimination; c2015 [cited 2018 Oct 30]. Tuberculosis (TB). Available from: <https://www.cdc.gov/tb/publications/factsheets/testing/igra.htm>
176. Al Houqani M, Jamieson F, Chedore P, Mehta M, May K, Marras TK. Isolation prevalence of pulmonary nontuberculous mycobacteria in Ontario in 2007. *Can Respir J*. 2011;18(1):19–24.
177. Billinger ME, Olivier KN, Viboud C, de Oca RM, Steiner C, Holland SM, et al. Nontuberculous mycobacteria-associated lung disease in hospitalized persons, United States, 1998–2005. *Emerg Infect Dis*. 2009;15(10):1562–9.
178. van Ingen J. Diagnosis of nontuberculous mycobacterial infections. *Semin Respir Crit Care Med*. 2013;34(1):103–9.
179. Sabin AP, Ferrieri P, Kline S. *Mycobacterium abscessus* Complex Infections in Children: A Review. *Curr Infect Dis Rep*. 2017;19(11):46.
180. Lindeboom JA, Kuijper EJ, Bruijnesteijn van Coppenraet ES, Lindeboom R, Prins JM. Surgical excision versus antibiotic treatment for nontuberculous mycobacterial cervicofacial lymphadenitis in children: a multicenter, randomized, controlled trial. *Clin Infect Dis*. 2007;44(8):1057–64.
181. Bar-On O, Mussaffi H, Mei-Zahav M, Prais D, Steuer G, Stafler P, et al. Increasing nontuberculous mycobacteria infection in cystic fibrosis. *J Cyst Fibros*. 2015;14(1):53–62.
182. Candido PH, Nunes Lde S, Marques EA, Folescu TW, Coelho FS, de Moura VC, et al. Multidrug-resistant nontuberculous mycobacteria isolated from cystic fibrosis patients. *J Clin Microbiol*. 2014;52(8):2990–7.
183. Chappler RR, Hoke AW, Borchardt KA. Primary inoculation with *Mycobacterium marinum*. *Arch Dermatol*. 1977;113(3):380.
184. Biet F, Boschirolì ML, Thorel MF, Guilloteau LA. Zoonotic aspects of *Mycobacterium bovis* and *Mycobacterium avium-intracellulare* complex (MAC). *Vet Res*. 2005;36(3):411–36.
185. Kim SY, Shin SJ, Lee NY, Koh WJ. First case of pulmonary disease caused by a *Mycobacterium avium* complex strain of presumed veterinary origin in an adult human patient. *J Clin Microbiol*. 2013;51(6):1993–5.

186. Elias J, Frosch M, Vogel U. Neisseria. In: Jorgensen JH, Pfaller MA, Carroll KC, Funke G, Landry ML, Richter SS, Warnock DW, editors. *Manual of Clinical Microbiology*, Volume 1. 11th ed. Washington (DC): ASM Press; 2015. p. 635–51.
187. Bruins SC, Tight RR. Laboratory-acquired gonococcal conjunctivitis. *JAMA*. 1979;241(3):274.
188. Diena BB, Wallace R, Ashton FE, Johnson W, Platenaude B. Gonococcal conjunctivitis: accidental infection. *Can Med Assoc J*. 1976;115(7):609, 12.
189. Malhotra R, Karim QN, Acheson JF. Hospital-acquired adult gonococcal conjunctivitis. *J Infect*. 1998;37(3):305.
190. Zajdowicz TR, Kerbs SB, Berg SW, Harrison WO. Laboratory-acquired gonococcal conjunctivitis: successful treatment with single-dose ceftriaxone. *Sex Transm Dis*. 1984;11(1):28–9.
191. U.S. Department of Health and Human Services. *Sexually Transmitted Disease Surveillance 2016*. Atlanta (GA): Centers for Disease Control and Prevention; 2017. 164 p.
192. Centers for Disease Control and Prevention. *Sexually Transmitted Diseases Treatment Guidelines, 2015*. *Morbidity and Mortality Weekly Report* 64 (3). 2015.
193. Cohn AC, MacNeil JR, Clark TA, Ortega-Sanchez IR, Briere EZ, Meissner HC, et al. Prevention and control of meningococcal disease: recommendations of the Advisory Committee on Immunization Practices (ACIP). *MMWR Recomm Rep*. 2013;62(RR-2):1–28.
194. Sheets CD, Harriman K, Zipprich J, Louie JK, Probert WS, Horowitz M, et al. Fatal meningococcal disease in a laboratory worker—California, 2012. *MMWR Morb Mortal Wkly Rep*. 2014;63(35):770–2.
195. Centers for Disease Control and Prevention. *Laboratory-acquired meningococcal disease—United States, 2000*. *MMWR Morb Mortal Wkly Rep*. 2002;51(7):141–4.
196. Patton ME, Stephens D, Moore K, MacNeil JR. Updated Recommendations for Use of MenB-FHbp Serogroup B Meningococcal Vaccine—Advisory Committee on Immunization Practices, 2016. *MMWR Morb Mortal Wkly Rep*. 2017;66(19):509–13.
197. Immunization of health-care workers: recommendations of the Advisory Committee on Immunization Practices (ACIP) and the Hospital Infection Control Practices Advisory Committee (HICPAC). *MMWR Recomm Rep*. 1997;46(RR-18):1–42.
198. Grogan J, Roos K. Serogroup B Meningococcus Outbreaks, Prevalence, and the Case for Standard Vaccination. *Curr Infect Dis Rep*. 2017;19(9):30.

199. Strockbine NA, Bopp CA, Fields PI, Kaper JB, Nataro JP. *Escherichia*, *Shigella*, and *Salmonella*. In: Jorgensen JH, Pfaller MA, Carroll KC, Funke G, Landry ML, Richter SS, Warnock DW, editors. Manual of Clinical Microbiology, Volume 1. 11th ed. Washington (DC): ASM Press; 2015. p. 685–713.
200. Dekker JP, Frank KM. *Salmonella*, *Shigella*, and *Yersinia*. Clin Lab Med. 2015;35(2):225–46.
201. Alexander DC, Fitzgerald SF, DePaulo R, Kitzul R, Daku D, Levett PN, et al. Laboratory-Acquired Infection with *Salmonella enterica* serovar Typhimurium Exposed by Whole-Genome Sequencing. J Clin Microbiol. 2016;54(1):190–3.
202. Barker A, Duster M, Van Hoof S, Safdar N. Nontyphoidal *Salmonella*: An Occupational Hazard for Clinical Laboratory Workers. Appl Biosaf. 2015;20(2):72–4.
203. Grist NR, Emslie JA. Infections in British clinical laboratories, 1984–5. J Clin Pathol. 1987;40(8):826–9.
204. Nicklas W. Introduction of Salmonellae into a centralized laboratory animal facility by infected day old chicks. Lab Anim. 1987;21(2):161–3.
205. Steckelberg JM, Terrell CL, Edson RS. Laboratory-acquired *Salmonella* Typhimurium enteritis: association with erythema nodosum and reactive arthritis. Am J Med. 1988;85(5):705–7.
206. Centers for Disease Control and Prevention [Internet]. Atlanta (GA): National Center for Emerging and Zoonotic Infectious Diseases, Division of Vector-Borne Diseases; c2018 [cited Oct 30]. Plague. Available from: <https://www.cdc.gov/plague/index.html>
207. Majowicz SE, Musto J, Scallan E, Angulo FJ, Kirk M, O'Brien SJ, et al. The global burden of nontyphoidal *Salmonella* gastroenteritis. Clin Infect Dis. 2010;50(6):882–9.
208. Ao TT, Feasey NA, Gordon MA, Keddy KH, Angulo FJ, Crump JA. Global burden of invasive nontyphoidal *Salmonella* disease, 2010. Emerg Infect Dis. 2015;21(6).
209. Gambino-Shirley K, Stevenson L, Wargo K, Burnworth L, Roberts J, Garrett N, et al. Notes from the Field: Four Multistate Outbreaks of Human *Salmonella* Infections Linked to Small Turtle Exposure—United States, 2015. MMWR Morb Mortal Wkly Rep. 2016;65(25):655–6.
210. Whiley H, Gardner MG, Ross K. A Review of *Salmonella* and Squamates (Lizards, Snakes and Amphibians): Implications for Public Health. Pathogens. 2017;6(3). pii: E38.

211. Kariuki S, Gordon MA, Feasey N, Parry CM. Antimicrobial resistance and management of invasive *Salmonella* disease. *Vaccine*. 2015;33 Suppl 3:C21–9.
212. Fuche FJ, Sow O, Simon R, Tennant SM. *Salmonella* Serogroup C: Current Status of Vaccines and Why They Are Needed. *Clin Vaccine Immunol*. 2016;23(9):737–45.
213. Stuart BM, Pullen RL. Typhoid; clinical analysis of 360 cases. *Arch Intern Med (Chic)*. 1946;78(6):629–61.
214. Buckle GC, Walker CL, Black RE. Typhoid fever and paratyphoid fever: Systematic review to estimate global morbidity and mortality for 2010. *J Glob Health*. 2012;2(1):010401.
215. Crump JA, Luby SP, Mintz ED. The global burden of typhoid fever. *Bull World Health Organ*. 2004;82(5):346–53.
216. Centers for Disease Control and Prevention [Internet]. Atlanta (GA): National Center for Emerging and Zoonotic Infectious Diseases, Division of Foodborne, Waterborne, and Environmental Diseases; c2018 [cited 2018 Oct 31]. *Salmonella*. Available from: <https://www.cdc.gov/salmonella/index.html>
217. Crump JA, Sjolund-Karlsson M, Gordon MA, Parry CM. Epidemiology, Clinical Presentation, Laboratory Diagnosis, Antimicrobial Resistance, and Antimicrobial Management of Invasive *Salmonella* Infections. *Clin Microbiol Rev*. 2015;28(4):901–37.
218. Jackson BR, Iqbal S, Mahon B; Centers for Disease Control and Prevention. Updated recommendations for the use of typhoid vaccine—Advisory Committee on Immunization Practices, United States, 2015. *MMWR Morb Mortal Wkly Rep*. 2015;64(11):305–8.
219. Laboratory acquired infection with *Escherichia coli* O157. *Commun Dis Rep CDR Wkly*. 1994;4(7):29.
220. *Escherichia coli* O157 infection acquired in the laboratory. *Commun Dis Rep CDR Wkly*. 1996;6(28):239.
221. Booth L, Rowe B. Possible occupational acquisition of *Escherichia coli* O157 infection. *Lancet*. 1993;342(8882):1298–9.
222. Burnens AP, Zbinden R, Kaempf L, Heinzer I, Nicolet J. A case of laboratory acquired infection with *Escherichia coli* O157:H7. *Zentralbl Bakteriol*. 1993;279(4):512–7.
223. Rao GG, Saunders BP, Masterton RG. Laboratory acquired verotoxin producing *Escherichia coli* (VTEC) infection. *J Hosp Infect*. 1996;33(3):228–30.

224. Nielsen EM, Skov MN, Madsen JJ, Lodal J, Jespersen JB, Baggesen DL. Verocytotoxin-producing *Escherichia coli* in wild birds and rodents in close proximity to farms. *Appl Environ Microbiol*. 2004;70(11):6944–7.
225. Bopp DJ, Sauders BD, Waring AL, Ackelsberg J, Dumas N, Braun-Howland E, et al. Detection, isolation, and molecular subtyping of *Escherichia coli* O157:H7 and *Campylobacter jejuni* associated with a large waterborne outbreak. *J Clin Microbiol*. 2003;41(1):174–80.
226. Friedman MS, Roels T, Koehler JE, Feldman L, Bibb WF, Blake P. *Escherichia coli* O157:H7 outbreak associated with an improperly chlorinated swimming pool. *Clin Infect Dis*. 1999;29(2):298–303.
227. Swerdlow DL, Woodruff BA, Brady RC, Griffin PM, Tippen S, Donnell HD Jr, et al. A waterborne outbreak in Missouri of *Escherichia coli* O157:H7 associated with bloody diarrhea and death. *Ann Intern Med*. 1992;117(10):812–9.
228. Walker D, Campbell D. A survey of infections in United Kingdom laboratories, 1994–1995. *J Clin Pathol*. 1999;52(6):415–8.
229. National Research Council. Zoonoses. In: National Research Council. Occupational Health and Safety in the Care and Use of Research Animals. Washington (DC): National Academy Press; 1997. p. 65–105.
230. Batz MB, Henke E, Kowalczyk B. Long-term consequences of foodborne infections. *Infect Dis Clin North Am*. 2013;27(3):599–616.
231. Liu C, Bayer A, Cosgrove SE, Daum RS, Fridkin SK, Gorwitz RJ, et al. Clinical practice guidelines by the infectious diseases society of america for the treatment of methicillin-resistant *Staphylococcus aureus* infections in adults and children: executive summary. *Clin Infect Dis*. 2011;52(3):285–92.
232. Banerjee T, Anupurba S. Colonization with vancomycin-intermediate *Staphylococcus aureus* strains containing the vanA resistance gene in a tertiary-care center in north India. *J Clin Microbiol*. 2012;50(5):1730–2.
233. Howden BP, Davies JK, Johnson PD, Stinear TP, Grayson ML. Reduced vancomycin susceptibility in *Staphylococcus aureus*, including vancomycin-intermediate and heterogeneous vancomycin-intermediate strains: resistance mechanisms, laboratory detection, and clinical implications. *Clin Microbiol Rev*. 2010;23(1):99–139.
234. Duman Y, Yakupogullari Y, Oflu B, Tekerekoglu MS. Laboratory-acquired skin infections in a clinical microbiologist: Is wearing only gloves really safe? *Am J Infect Control*. 2016;44(8):935–7.
235. Gosbell IB, Mercer JL, Neville SA. Laboratory-acquired EMRSA-15 infection. *J Hosp Infect*. 2003;54(4):323–5.

236. Wagenvoort JH, De Brauwer EI, Gronenschild JM, Toenbreker HM, Bonnemayers GP, Bilkert-Mooiman MA. Laboratory-acquired meticillin-resistant *Staphylococcus aureus* (MRSA) in two microbiology laboratory technicians. *Eur J Clin Microbiol Infect Dis*. 2006;25(7):470–2.
237. Centers for Disease Control and Prevention [Internet]. Atlanta (GA): National Center for Emerging and Zoonotic Infectious Diseases, Division of Healthcare Quality Promotion; c2015 [cited 2018 Oct 31]. Healthcare-associated Infections. Available from: https://www.cdc.gov/hai/organisms/visa_vrsa/visa_vrsa.html
238. Kluytmans J, van Belkum A, Verbrugh H. Nasal carriage of *Staphylococcus aureus*: epidemiology, underlying mechanisms, and associated risks. *Clin Microbiol Rev*. 1997;10(3):505–20.
239. Pantosti A. Methicillin-Resistant *Staphylococcus aureus* Associated with Animals and Its Relevance to Human Health. *Front Microbiol*. 2012;3:127.
240. Peeling RW, Mabey DC. Syphilis. *Nat Rev Microbiol*. 2004;2(6):448–9.
241. Fitzgerald JJ, Johnson RC, Smith M. Accidental laboratory infection with *Treponema pallidum*, Nichols strain. *J Am Vener Dis Assoc*. 1976;3(2 Pt 1): 76–8.
242. Chacko CW. Accidental human infection in the laboratory with Nichols rabbit-adapted virulent strain of *Treponema pallidum*. *Bull World Health Organ*. 1966;35(5):809–10.
243. Turner TB, Hardy PH, Newman B. Infectivity tests in syphilis. *Br J Vener Dis*. 1969;45(3):183–95.
244. Silver AC, Dunne DW, Zeiss CJ, Bockenstedt LK, Radolf JD, Salazar JC, et al. MyD88 deficiency markedly worsens tissue inflammation and bacterial clearance in mice infected with *Treponema pallidum*, the agent of syphilis. *PLoS One*. 2013;8(8):e71388.
245. Knauf S, Liu H, Harper KN. Treponemal infection in nonhuman primates as possible reservoir for human yaws. *Emerg Infect Dis*. 2013;19(12):2058–60.
246. Sena AC, Pillay A, Cox DL, Radolf JD. *Treponema* and *Brachyspira*, Human Host-Associated Spirochetes. In: Jorgensen JH, Pfaller MA, Carroll KC, Funke G, Landry ML, Richter SS, Warnock DW, editors. *Manual of Clinical Microbiology*, Volume 1. 11th ed. Washington (DC): ASM Press; 2015. p. 1055–81.
247. Centers for Disease Control and Prevention [Internet]. Atlanta (GA): National Center for Emerging and Zoonotic Infectious Diseases, Division of Foodborne, Waterborne, and Environmental Diseases; c2018 [cited 2018 Oct 31]. Cholera—*Vibrio cholerae* infection. Available from: <https://www.cdc.gov/cholera/index.html>

248. Centers for Disease Control and Prevention [Internet]. Atlanta (GA): National Center for Emerging and Zoonotic Infectious Diseases, Division of Foodborne, Waterborne, and Environmental Diseases; c2018 [cited 2018 Oct 31]. *Vibrio* Species Causing Vibriosis. Available from: <https://www.cdc.gov/vibrio/surveillance.html>
249. Huhulescu S, Leitner E, Feierl G, Allerberger F. Laboratory-acquired *Vibrio cholerae* O1 infection in Austria, 2008. *Clin Microbiol Infect*. 2010;16(8):1303–4.
250. Sheehy TW, Sprinz H, Augerson WS, Formal SB. Laboratory *Vibrio cholerae* infection in the United States. *JAMA*. 1966;197(5):321–6.
251. Lee KK, Liu PC, Huang CY. *Vibrio parahaemolyticus* infectious for both humans and edible mollusk abalone. *Microbes Infect*. 2003;5(6):481–5.
252. Daniels NA, Ray B, Easton A, Marano N, Kahn E, McShan AL 2nd, et al. Emergence of a new *Vibrio parahaemolyticus* serotype in raw oysters: A prevention quandary. *JAMA*. 2000;284(12):1541–5. Erratum in: *JAMA*. 2001;285(2):169.
253. American Public Health Association. Cholera and other vibrioses. In: Heymann DL, editor. *Control of Communicable Diseases Manual*. 20th ed. Washington (DC): APHA Press; 2015. p. 102–14.
254. Wong KK, Burdette E, Mahon BE, Mintz ED, Ryan ET, Reingold AL. Recommendations of the Advisory Committee on Immunization Practices for Use of Cholera Vaccine. *MMWR Morb Mortal Wkly Rep*. 2017;66(18):482–5.
255. American Committee of Medical Entomology; American Society of Tropical Medicine and Hygiene. *Arthropod Containment Guidelines, Version 3.2*. A project of the American Committee of Medical Entomology and American Society of Tropical Medicine and Hygiene. *Vector Borne Zoonotic Dis*. 2019;19(3):152–73.
256. Centers for Disease Control and Prevention. Fatal laboratory-acquired infection with an attenuated *Yersinia pestis* Strain—Chicago, Illinois, 2009. *MMWR Morb Mortal Wkly Rep*. 2011;60(7):201–5.
257. Eads DA, Hoogland JL. Precipitation, Climate Change, and Parasitism of Prairie Dogs by Fleas that Transmit Plague. *J Parasitol*. 2017;103(4):309–19.
258. Burmeister RW, Tigertt WD, Overholt EL. Laboratory-acquired pneumonic plague. Report of a case and review of previous cases. *Ann Intern Med*. 1962;56:789–800.
259. Titball RW, Williamson ED. *Yersinia pestis* (plague) vaccines. *Expert Opin Biol Ther*. 2004;4(6):965–73.

Section VIII-B: Fungal Agents

Blastomyces dermatitidis* and *Blastomyces gilchristii

Blastomyces dermatitidis is a dimorphic fungal pathogen existing in nature and in laboratory cultures at room temperature as a filamentous mold with asexual spores (conidia) that are the infectious particles; conidia convert to large budding yeasts under the appropriate culture conditions *in vitro* at 37°C and in the parasitic phase *in vivo* in warm-blooded animals. Infections with *B. dermatitidis* occur when conidia are inhaled or when yeast forms are injected. The sexual stage is an Ascomycete with infectious ascospores. *Blastomyces gilchristii* was recently recognized as a novel species found predominantly in northwestern Ontario, Wisconsin, and Minnesota.¹

Occupational Infections

Three groups are at greatest risk of Laboratory-associated infection (LAI): microbiologists, veterinarians, and pathologists.² Laboratory-associated local infections have been reported following accidental parenteral inoculation with infected tissues or cultures containing yeast forms of *B. dermatitidis*.³⁻⁹ Laboratory infections have also occurred following the presumed inhalation of conidia from mold-form cultures.^{10,11} Infection with *B. dermatitidis* can be pulmonary, cutaneous, or disseminated. Disseminated blastomycosis usually begins with pulmonary infection. Transmission occurs rarely via animal bites, sexual means, or vertical transmission. Forestry workers and other workers with outdoor occupations have developed blastomycosis after exposure to contaminated soil or plant material, particularly moist soil with decaying vegetation.¹² At least 11 reported LAIs with two fatalities have occurred.^{13,14}

Natural Modes of Infection

The fungus has been reported in multiple geographically separated countries, but it is best known as a fungus endemic to North America and in association with plant material in the environment. Infections are not communicable but require common exposure from a point source. Although presumed to dwell within the soil of endemic areas, *B. dermatitidis* is extremely difficult to isolate from soil. Outbreaks associated with the exposure of people to decaying wood have been reported. However, outdoor activities were not a risk factor in the largest outbreak reported through 2017; instead, the large Hmong population in the area of Wisconsin that was involved in the outbreak may have had an underlying genetic predisposition.¹⁵ *B. dermatitidis* infections are most common in humans and dogs though other animals, such as cats and horses, may also develop blastomycosis. Human-to-human transmission occurs rarely via perinatal or sexual transmission.

Laboratory Safety and Containment Recommendations

Yeast forms may be present in the tissues of infected animals and in clinical specimens. Parenteral (subcutaneous) inoculation of these materials may cause local skin infection and granulomas. Mold-form cultures of *B. dermatitidis* containing infectious conidia and processing of soil or other environmental samples may pose a hazard of aerosol exposure.

BSL-3 practices, containment equipment, and facilities are recommended for handling sporulating mold-form cultures already identified as *B. dermatitidis* and soil or other environmental samples known or likely to contain infectious conidia.

BSL-2 and ABSL-2 practices, containment equipment, and facilities are recommended for activities with clinical materials, animal tissues, yeast-form cultures, and infected animals.

Special Issues

Transfer of Agent Importation of this agent requires CDC and/or USDA importation permits. Domestic transport of this agent may require a permit from USDA APHIS VS. A DoC permit may be required for the export of this agent to another country. See [Appendix C](#) for additional information.

Coccidioides immitis* and *Coccidioides posadasii

Coccidioides spp. are endemic to the Sonoran Desert of the western hemisphere including northern Mexico, southern Arizona, central and southern California, and western Texas. In recent decades, *C. immitis* has been divided into two species: *C. immitis* and *C. posadasii*.¹⁶ These species are dimorphic fungal pathogens existing in nature and in laboratory cultures at room temperature as filamentous molds with asexual spores (single-cell arthroconidia three to five microns in size) that are the infectious particles. The arthroconidia convert to spherules under the appropriate culture conditions *in vitro* at 37°C and *in vivo* in warm-blooded animals.

Occupational Infections

Laboratory-associated coccidioidomycosis is a documented hazard of working with sporulating cultures of *Coccidioides* spp.^{17–19} Occupational exposure in archeologists and prison employees in endemic regions has been associated with high dust exposure.^{20,21} Attack rates for laboratory and occupational exposures where a larger number of spores are inhaled are higher than for non-occupational environmental exposures. Smith reported that 28 of 31 (90%) Laboratory-associated infections in his institution resulted in clinical disease, but more than half of infections acquired in nature were asymptomatic.²² Risk of respiratory infection from exposure to infected tissue or aerosols of infected secretions is very low. Accidental percutaneous inoculation has typically resulted in localized granuloma formation.²³

Natural Modes of Infection

Single spores in environmental exposures can produce infections by the respiratory route. Peak exposures occur during arid seasons, and exposure can also occur during natural disasters such as earthquakes.²⁴ *Coccidioides* spp. grow in infected tissue as larger multicellular spherules up to 70 microns in diameter and pose little or no risk of infection from direct exposure.

Most infections from environmental exposure are subclinical and result in life-long protection from subsequent exposures. The incubation period is one to three weeks, and the disease manifests as community-acquired pneumonia with immunologically mediated fatigue, skin rashes, and joint pain. One of the synonyms for coccidioidomycosis is desert rheumatism. A small proportion of infections are complicated by hematogenous dissemination from the lungs to other organs, most frequently skin, the skeleton, and the meninges. Disseminated infection is much more likely in persons with cellular immunodeficiencies (e.g., AIDS, organ transplant recipient, lymphoma, receipt of tumor necrosis factor [TNF] inhibitors) and in pregnant women in the third trimester.

Laboratory Safety and Containment Recommendations

Because of their size, arthroconidia are conducive to ready dispersal in air and retention in the deep pulmonary spaces. The much larger size of the spherule considerably reduces the effectiveness of this form of the fungus as an airborne pathogen.

Spherules of the fungus may be present in clinical specimens and animal tissues, and infectious arthroconidia may be present in mold cultures and soil or other samples from natural sites. Inhalation of arthroconidia from either environmental samples or mold isolates is a serious laboratory hazard.¹⁹ Most exposures occur due to personnel handling cultures of unknown infectious status on the bench, rather than in a BSC. Personnel should be aware that infected animal or human clinical specimens or tissues stored or shipped under temperature and nutrient conditions that could promote germination of arthroconidia pose a theoretical laboratory hazard. Slide cultures should never be prepared from unknown hyaline (colorless) isolates, as they could contain *Coccidioides* spp.

BSL-3 practices, containment equipment, and facilities are recommended for propagating and manipulating sporulating cultures already identified as *Coccidioides* spp. and for processing soil or other environmental materials known or suspected to contain infectious arthroconidia. Experimental animal studies should be done at BSL-3 when challenge is via the intranasal or pulmonary route.

BSL-2 practices, containment equipment, and facilities are recommended for handling and processing clinical specimens, identifying isolates, and processing animal tissues that may contain *Coccidioides* spp. ABSL-2 practices, containment

equipment, and facilities are appropriate for experimental animal studies when the route of challenge is parenteral.

Special Issues

Transfer of Agent Importation of this agent requires CDC and/or USDA importation permits. Domestic transport of this agent may require a permit from USDA APHIS VS. A DoC permit may be required for the export of this agent to another country. See [Appendix C](#) for additional information.

Histoplasma capsulatum

Histoplasma capsulatum is a dimorphic fungal pathogen existing in nature and in laboratory cultures at room temperature as a filamentous mold with asexual spores (macro-and/or microconidia); microconidia are the infectious particles that convert to small budding yeasts under the appropriate culture conditions in vitro at 37°C and in the parasitic phase in vivo. The sexual stage is an Ascomycete with infectious ascospores.

Specific hazards/risks associated with *Histoplasma* include:

1. Immunocompromised individuals are at increased risk of infection and experience more severe infections and higher mortality;
2. Dissemination throughout body has resulted in death but usually results in chronic infection;
3. Previously controlled infections can be re-activated when cellular immunity is impaired;
4. The adrenal gland can be destroyed by visceral infection; and
5. 5–20% of cases involve the central nervous system and appear as chronic meningitis or focal brain lesions.

Occupational Infections

Laboratory-associated histoplasmosis is a documented hazard in facilities conducting diagnostic or investigative work.^{9,25–27} Pulmonary infections have resulted from handling mold form cultures,^{28,29} Local infection has resulted from skin puncture during autopsy of an infected human,³⁰ from accidental needle inoculation of a viable culture,³¹ from accidental inoculation with a lymph node biopsy sample from an infected patient,³² and from spray into the eye.³³ Collecting and processing soil samples from endemic areas has caused pulmonary infections in laboratory workers,³⁴ and one death was reported in 1962.³⁵ Conidia are resistant to drying and may remain viable for long periods of time. The small size of the infective conidia (less than five microns) is conducive to airborne dispersal and intrapulmonary retention. Work with experimental animals suggests that hyphal fragments are also capable of serving as viable inocula.²⁵

Natural Modes of Infection

The fungus is distributed worldwide in the environment and is associated with bird and bat feces. It has been isolated from soil, often in river valleys, between latitudes 45°N and 45°S. Histoplasmosis is naturally acquired by the inhalation of infectious microconidia, which can survive in excess of ten years in soil.²⁵ Infections are not transmissible from person-to-person but require common exposure to a point source. Large outbreaks have been reported from exposure to soil or plant material contaminated with bird or bat feces^{36,37} and from exposure to soil during construction projects.³⁸

Laboratory Safety and Containment Recommendations

The infective stage of this dimorphic fungus (microconidia) is present in sporulating mold form cultures and in soil from endemic areas. The yeast form is present in tissues or fluids from infected animals and may produce local infection following parenteral inoculation or splash onto mucous membranes.

BSL-3 practices, containment equipment, and facilities are recommended for propagating sporulating cultures of *H. capsulatum* in the mold form, as well as for processing soil or other environmental materials known or likely to contain infectious conidia.

BSL-2 and ABSL-2 practices, containment equipment, and facilities are recommended for handling and processing clinical specimens; identifying isolates, animal tissues, and mold cultures; identifying cultures that may contain *Histoplasma* in routine diagnostic laboratories; and for inoculating experimental animals, regardless of route. Any culture identifying dimorphic fungi should be handled in a Class II BSC. Protective eyewear should be worn when splash(es) to mucous membranes may occur.

Special Issues

Transfer of Agent Importation of this agent requires CDC and/or USDA importation permits. Domestic transport of this agent may require a permit from USDA APHIS VS. A DoC permit may be required for the export of this agent to another country. See [Appendix C](#) for additional information.

***Sporothrix schenckii* species complex**

The *Sporothrix schenckii* species complex is composed of at least six species (*Sporothrix brasiliensis*, *Sporothrix mexicana*, *Sporothrix globosa*, *S. schenckii sensu stricto*, *Sporothrix luriei*, and *Sporothrix albicans*) of dimorphic fungal pathogens existing in nature and in laboratory cultures at room temperature as filamentous mold with asexual spores (conidia); the conidia are the infectious particles that convert to small budding yeasts in the parasitic phase in vivo.³⁹ The sexual stage is unknown.

Occupational Infections

Most cases of sporotrichosis are reported sporadically following accidental inoculation with contaminated material. Large outbreaks have been documented in persons occupationally or recreationally exposed to soil or plant material containing the fungus. However, members of the *S. schenckii* species complex have caused a substantial number of local skin or eye infections in laboratory personnel.⁴⁰ Most occupational cases have been associated with accidents and have involved splashing culture material into the eye,^{41,42} scratching,⁴³ injecting infected material into the skin,⁴⁴ or being bitten by an experimentally infected animal.^{45,46} Skin infections without any apparent trauma to the skin have also resulted from handling cultures^{47–49} and from the necropsy of animals.⁵⁰

Laboratory Safety and Containment Recommendations

Although localized skin and eye infections have occurred in an occupational setting, no pulmonary infections have been reported as a result of laboratory exposure. It should be noted that serious disseminated infections have been reported in immunocompromised persons.⁵¹

BSL-2 and ABSL-2 practices, containment equipment, and facilities are recommended for laboratory handling of clinical specimens suspected of containing infectious particles, soil and vegetation suspected to contain *S. schenckii*, and experimental animal activities with *S. schenckii*. Any culture identifying dimorphic fungi should be handled in a Class II BSC. Protective eyewear should be worn when splash(es) to mucous membranes may occur.

Special Issues

Transfer of Agent Importation of this agent requires CDC and/or USDA importation permits. Domestic transport of this agent may require a permit from USDA APHIS VS. A DoC permit may be required for the export of this agent to another country. See [Appendix C](#) for additional information.

Miscellaneous Yeast and mold organisms causing human infection

The majority of mold organisms in Table 1 cause infection in compromised hosts. Risk factors may include neutropenia, previous exposure to antibiotics, treatment for cancer, especially leukemia and lymphoma, organ or stem cell transplant, severe burns, HIV infection with low CD4 cell counts, and placement of central lines or other monitoring devices.

The majority of these organisms are found in the environment and are transmitted through exposure to air, water, or dust. Mold conidia can be inhaled or injected subcutaneously through trauma or other accidental inoculation. Dermatophytes can be transmitted through the person-to-person route, the animal-to-person route, and the environment-to-person route.

Candida yeasts are found as part of the normal human respiratory or gastrointestinal flora and may cause infection after exposure to antibiotics, abdominal surgery, or other causes. Yeast outbreaks in hospitals can occur through exposure to contaminated hospital equipment, foods, or medications. Some yeast species, most notably *Candida auris*,⁵² cause concern because they display resistance to multiple antifungal drugs. *Cryptococcus* basidiospores are found in the environment largely associated with bird droppings or certain trees. They cause infection in compromised hosts after inhaling fungal spores.

BSL-2 and ABSL-2 practices, containment equipment, and facilities are recommended for propagating and manipulating cultures known to contain these agents. All unknown mold cultures should be handled in a Class II BSC.

Table 1. Miscellaneous Yeast and Mold

Agent	Occupational Infection	Natural Mode of Infection	Biosafety Level
<i>Candida</i> species	Not common	From point source in environment; from gastrointestinal tract into bloodstream	BSL-2
<i>Cryptococcus neoformans</i> and <i>C. gattii</i>	Occasional inoculation into skin when working with laboratory animals	Inhalation from point source in environment. No person-to-person transmission reported.	BSL-2 (handle in BSC to prevent laboratory contamination)
Dermatophyte molds: <i>Trichophyton</i> , <i>Microsporum</i> , <i>Epidermophyton</i> species	Occasional direct inoculation from handling isolates or contaminated materials	Person-to-person; common exposure to a point source; handling infected animals	BSL-2
Hyaline Molds: <i>Aspergillus</i> spp., <i>Fusarium</i> spp.	Not common	Presumed inhalation; subcutaneous inoculation from environmental source	BSL-2 (handle in BSC to prevent laboratory contamination)
<i>Talaromyces (Penicillium) marneffeii</i>	Occasional direct inoculation when working with laboratory animals; rare inhalation in immunocompromised individual	Mostly inhalation (in immunocompromised hosts)	BSL-2 (handle in BSC to prevent laboratory contamination)

Continued on next page ►

Agent	Occupational Infection	Natural Mode of Infection	Biosafety Level
Dematiaceous Molds: <i>Bipolaris</i> spp.; <i>Cladophialophora bantiana</i> ; <i>Exophiala</i> spp.; <i>Exserohilum rostratum</i> ; <i>Fonsecaea</i> spp.; <i>Pseudallescheria</i> spp.; <i>Rhinocladiella</i> spp.; <i>Scedosporium</i> spp.; <i>Verruconis (Ochroconis) gallopava</i>	Not reported, but inhalation or subcutaneous inoculation are possible routes of exposure	Presumed inhalation; subcutaneous inoculation from environmental source. <i>C. bantiana</i> , <i>E. dermatitidis</i> , <i>V. gallopava</i> , and <i>R. mackenziei</i> are neurotropic. <i>C. bantiana</i> can cause disseminated infection in otherwise healthy hosts.	BSL-2 (handle in BSC to prevent laboratory contamination)
Mucormycete molds: <i>Mucor</i> spp.; <i>Rhizopus</i> spp.; <i>Rhizomucor</i> spp.; <i>Lichtheimia (Absidia)</i> spp.	Not reported	Presumed inhalation; subcutaneous inoculation from environmental source; ingestion	BSL-2 (handle in BSC to prevent laboratory contamination)

References

1. Brown EM, McTaggart LR, Zhang SX, Low DE, Stevens, DA, Richardson SE. Phylogenetic analysis reveals a cryptic species *Blastomyces gilchristii*, sp. nov. within the human pathogenic fungus *Blastomyces dermatitidis*. PLoS One. 2013;8(3):e59237. Erratum in: PLoS One. 2016.
2. DiSalvo AF. The epidemiology of blastomycosis. In: Al-Doory Y, DiSalvo AF, editors. Blastomycosis. New York: Plenum Medical Book Company; 1992. p. 75–104.
3. Evans N. A clinical report of a case of blastomycosis of the skin from accidental inoculation. JAMA. 1903;40(26):1172–5.
4. Harrell ER. The known and the unknown of the occupational mycoses. In: University of Michigan School of Public Health, author. Occupational diseases acquired from animals. Continued education series, No. 124. Ann Arbor (MI): University of Michigan, School of Public Health; 1964. p. 176–8.
5. Larsh HW, Schwarz J. Accidental inoculation blastomycosis. Cutis. 1977;19(3):334–5, 337.
6. Larson DM, Eckman MR, Alber RL, Goldschmidt VG. Primary cutaneous (inoculation) blastomycosis: an occupational hazard to pathologists. Amer J Clin Pathol. 1983;79(2):253–5.
7. Wilson JW, Cawley EP, Weidman FD, Gilmer WS. Primary cutaneous North American blastomycosis. AMA Arch Dermatol. 1955;71(1):39–45.
8. Graham WR Jr, Callaway JL. Primary inoculation blastomycosis in a veterinarian. J Am Acad Dermatol. 1982;7(6):785–6.

9. Schwarz J, Kauffman CA. Occupational hazards from deep mycoses. *Arch Dermatol.* 1977;113(9):1270–5.
10. Baum GL, Lerner PI. Primary pulmonary blastomycosis: a laboratory acquired infection. *Ann Intern Med.* 1970;73(2):263–5.
11. Denton JF, Di Salvo AF, Hirsch ML. Laboratory-acquired North American blastomycosis. *JAMA.* 1967;199(12):935–6.
12. Centers for Disease Control and Prevention. Blastomycosis acquired occupationally during prairie dog relocation—Colorado, 1998. *MMWR Morb Mortal Wkly Rept.* 1999;48(5):98–100.
13. Pike RM. Laboratory-associated infections. Summary and analysis of 3921 cases. *Health Lab Sci.* 1976;13(2):105–14.
14. Schell WA. Mycotic Agents. In: Wooley DP, Byers KB, editors. *Biological Safety: Principles and Practices.* 5th ed. Washington (DC): ASM Press; 2017. p. 147–62.
15. Roy M, Benedict K, Deak E, Kirby MA, McNeil JT, Stickler CJ, et al. A large community outbreak of blastomycosis in Wisconsin with geographic and ethnic clustering. *Clin Infect Dis.* 2013;57(5):655–62.
16. Fisher MC, Koenig GL, White TJ, Taylor JW. Molecular and phenotypic description of *Coccidioides posadasii* sp nov, previously recognized as the non-California population of *Coccidioides immitis*. *Mycologia.* 2002;94(1):73–84.
17. Pappagianis D. Coccidioidomycosis (San Joaquin or Valley Fever). In: DiSalvo AF, editor. *Occupational mycoses.* Philadelphia (PA): Lea and Febiger; 1983. p. 13–28.
18. Nabarro JD. Primary pulmonary coccidioidomycosis: case of laboratory infection in England. *Lancet.* 1948;1(6513):982–4.
19. Stevens DA, Clemons KV, Levine HB, Pappagianis D, Baron EJ, Hamilton JR, et al. Expert opinion: what to do when there is *Coccidioides* exposure in a laboratory. *Clin Infect Dis.* 2009;49(6):919–23.
20. Petersen LR, Marshall SL, Barton-Dickson C, Hajjeh RA, Lindsley MD, Warnock DW, et al. Coccidioidomycosis among workers at an archeological site, northeastern Utah. *Emerg Infect Dis.* 2004;10(4):637–42.
21. de Perio MA, Niemeier RT, Burr GA. *Coccidioides* exposure and coccidioidomycosis among prison employees, California, United States. *Emerg Infect Dis.* 2015;21(6):1031–3.
22. Wilson JW, Smith CE, Plunkett OA. Primary cutaneous coccidioidomycosis: the criteria for diagnosis and a report of a case. *Calif Med.* 1953;79(3):233–9.

23. Tomlinson CC, Bancroft P. Granuloma *Coccidioides*: report of a case responding favorably to antimony and potassium tartrate. *JAMA*. 1928;91(13):947–51.
24. Schneider E, Hajjeh RA, Spiegel RA, Jibson RW, Harp EL, Marshall GA, et al. A coccidioidomycosis outbreak following the Northridge, Calif, earthquake. *JAMA*. 1997;277(11):904–8.
25. Furcolow ML. Airborne histoplasmosis. *Bacteriol Rev*. 1961;25:301–9.
26. Pike RM. Past and present hazards of working with infectious agents. *Arch Pathol Lab Med*. 1978;102(7):333–6.
27. Pike RM. Laboratory-associated infections: Summary and analysis of 3921 cases. *Health Lab Sci*. 1976;13(2):105–14.
28. Murray JF, Howard D. Laboratory-acquired histoplasmosis. *Am Rev Respir Dis*. 1964;89:631–40.
29. Sewell DL. Laboratory-associated infections and biosafety. *Clin Microbiol Rev*. 1995;8(3):389–405.
30. Tosh FE, Balhuizen J, Yates JL, Brasher CA. Primary cutaneous histoplasmosis: report of a case. *Arch Intern Med*. 1964;114:118–9.
31. Tesh RB, Schneidau JD. Primary cutaneous histoplasmosis. *N Engl J Med*. 1966;275(11):597–9.
32. Buitrago MJ, Gonzalo-Jimenez N, Navarro M, Rodriguez-Tudela JL, Cuenca-Estrella M. A case of primary cutaneous histoplasmosis acquired in the laboratory. *Mycoses* 2011;54(6):e859–61.
33. Spicknall CG, Ryan RW, Cain A. Laboratory-acquired histoplasmosis. *N Engl J Med*. 1956;254(5):210–4.
34. Vanselow NA, Davey WN, Bocobo FC. Acute pulmonary histoplasmosis in laboratory workers: report of 2 cases. *J Lab Clin Med*. 1962;59:236–43.
35. Pike RM. Laboratory-associated infections: incidence, fatalities, causes, and prevention. *Annu Rev Microbiol*. 1979;33:41–66.
36. Chamany S, Mirza SA, Fleming JW, Howell JF, Lenhart SW, Mortimer VD, et al. A large histoplasmosis outbreak among high school students in Indiana, 2001. *Pediatr Infect Dis J*. 2004;23(10):909–14.
37. Hoff GL, Bigler WJ. The role of bats in the propagation and spread of histoplasmosis: a review. *J Wildl Dis*. 1981;17:191–6.
38. Morgan J, Cano MV, Feikin DR, Phelan M, Monroy OV, Morales PK, et al. A large outbreak of histoplasmosis among American travelers associated with a hotel in Acapulco, Mexico, Spring 2001. *Am J Trop Med Hyg*. 2003;69(6):663–9.

39. Lopez-Romero E, Reyes-Montes Mdel R, Perez-Torres A, Ruiz-Baca E, Villagomez-Castro JC, Mora-Montes HM, et al. *Sporothrix schenckii* complex and sporotrichosis, an emerging public health problem. *Future Microbiol.* 2011;6(1):85–102.
40. Ishizaki H, Ikeda M, Kurata Y. Lymphocutaneous sporotrichosis caused by accidental inoculation. *J Dermatol.* 1979;6(5):321–3.
41. Fava A. Un cas de sporotrichose conjonctivale et palpébrale primitives. *Ann d'ocul.* 1909;338–43. French.
42. Wilder WH, McCullough CP. Sporotrichosis of the eye. *JAMA.* 1914;62(15):1156–60.
43. Carougeau M. Premier cas Africain de sporotrichose de deBeurmann: transmission de la sporotrichose du mulet a l'homme. *Bull Mém Soc Méd Hôp de Paris.* 1909;28:507–10. French.
44. Thompson DW, Kaplan W. Laboratory-acquired sporotrichosis. *Sabouraudia.* 1977;15(2):167–70.
45. Jeanselme E, Chevallier P. Chancre sporotrichosiques des doigts produits par la morsure d'un rat inoculé de sporotrichose. *Bull Mém Soc Méd Hôp de Paris.* 1910:176–8. French.
46. Jeanselme E, Chevallier P. Transmission de la sporotrichose a l'homme par les morsures d'un rat blanc inoculé avec une nouvelle variété de *Sporotrichum*: Lymphangite gommeuse ascendante. *Bull Mém Soc Méd Hôp de Paris.* 1911;31(3):287–301. French.
47. Meyer KF. The relation of animal to human sporotrichosis: studies on American sporotrichosis III. *JAMA.* 1915;65(7):579–85.
48. Norden A. Sporotrichosis; clinical and laboratory features and a serologic study in experimental animals and humans. *Acta Pathol Microbiol Scand Suppl.* 1951;89:1–119.
49. Cooper CR, Dixon DM, Salkin IF. Laboratory-acquired sporotrichosis. *J Med Vet Mycol.* 1992;30(2):169–71.
50. Fielitz H. Ueber eine Laboratoriumsinfektion mit dem *Sporotrichum* de Beurmanni. *Centralbl. f. Bakt. etc. I. Abt. Originale.* 1910;55(5):361–70. German.
51. Sugar AM, Lyman CA. *Sporothrix schenckii*. In: Sugar AM, Lyman CA. A practical guide to medically important fungi and the diseases they cause. Philadelphia (PA): Lippincott-Raven; 1997. p. 86–8.
52. McCarthy MW, Walsh TJ. Containment strategies to address the expanding threat of multidrug-resistant *Candida auris*. *Expert Rev Anti Infect Ther.* 2017;15(12):1095–99.

Section VIII-C: Parasitic Agents

General Issues

This section focuses on potential hazards of working in settings in which exposures to viable parasites could occur, and approaches to decrease the likelihood of accidental exposures. Available data are limited; the perspective provided is based on review of the literature regarding reported cases of occupationally-acquired parasitic infections, available information for selected parasites regarding potential intervention measures (e.g., disinfection approaches), and knowledge about parasite biology and about the epidemiology and clinical aspects of parasitic infections. Additional details regarding occupationally-acquired cases of parasitic infections and recommendations for post-exposure management are available elsewhere,¹⁻³ as is further perspective about zoonoses of occupational health importance in laboratory animal research.⁴ Information about diagnosing and treating parasitic infections and perspective regarding special considerations for persons who are immunocompromised or pregnant can be obtained from various reference materials, including the website of CDC's Division of Parasitic Diseases and Malaria, and are available at <https://www.cdc.gov/parasites>. Diagnostic resources and information about parasitic life cycles, including routes of transmission, are available through CDC's DPDx website at <https://www.cdc.gov/dpdx>.

Note: Microsporidia historically were considered parasites but are now recognized by most experts as fungi. However, because of their traditional association with parasitology, microsporidia are discussed in [Section VIII-C: Parasitic Agents](#).

Blood and Tissue Protozoal Parasites

In descending order of total number of reported cases of infection reported in the literature, the blood and tissue protozoal parasites that have been associated with documented cases of occupationally acquired infection are: *Trypanosoma cruzi*, *Plasmodium* spp., *Toxoplasma gondii*, *Leishmania* spp., and *Trypanosoma brucei* subsp.¹ Other blood/tissue protozoa of potential concern include *Babesia* spp., the free-living amebae, including *Acanthamoeba* spp., *Balamuthia mandrillaris*, *Naegleria fowleri*, and *Sappinia pedata*; and the *Sarcocystis* spp. that can cause intramuscular sarcocystosis. In addition, various genera/species of microsporidia (now classified as fungi) may pose an occupational risk for extraintestinal infection; see below regarding an occupationally-acquired case of microsporidiosis.

In alphabetical order: *Leishmania* spp. cause various syndromes, including visceral, cutaneous, and mucosal leishmaniasis (clinical presentation is in part species dependent); *Plasmodium* spp. cause malaria; *T. gondii* causes toxoplasmosis; *T. cruzi* causes American trypanosomiasis (Chagas disease); and *T. brucei* subsp. *gambiense* and subsp. *rhodesiense* cause human African trypanosomiasis

(sleeping sickness). Depending in part on parasite and host factors, infective stages of these parasites may be found in the bloodstream, either briefly (e.g., during a particular phase of the infection), intermittently, or during all or most of the course of the infection. Among these parasites, tissue tropisms vary by genus and species, including which, if any, tissues/organs may become infected and whether the tissue and blood stages of the parasite differ. Some of these pathogens have been reported to be transmitted via blood transfusion, organ/tissue transplantation, and congenitally.⁵⁻⁷

Occupational Infections

Occupationally-acquired cases of infection with *Leishmania* spp., *Plasmodium* spp., *T. gondii*, and *Trypanosoma* spp. have been reported. The most commonly reported modes of transmission have included sharps (e.g., needlestick) injuries and other percutaneous exposures (e.g., through preexisting cuts, breaks, or microabrasions).^{1,2} Vector-borne transmission to laboratorians has been reported, particularly for *Plasmodium* spp. (*P. falciparum*, *P. vivax*, and the simian parasite *P. cynomolgi*) but also for *T. cruzi* and *Leishmania major*.¹ Other reported laboratory routes of transmission have included mucous membrane exposures (*T. gondii*, *Leishmania* spp., and *T. cruzi*) and ingestion (*T. gondii*).^{1,2} Laboratory-associated cases of infection with *Leishmania* spp., *T. gondii*, and *T. cruzi* have also been reported in persons who were working with these organisms but did not recall a discrete accident or exposure.^{1,2}

Laboratory-associated cases of infection with blood/tissue protozoa may range from asymptomatic to severe. One individual with a reported case of laboratory-associated *Leishmania* infection developed clinical manifestations consistent with visceral involvement (e.g., fever, splenomegaly, leukopenia);^{1,2} this case was caused either by *L. donovani* or by *L. infantum*, which is in the *L. donovani* species complex. The other laboratorians with reported cases of occupationally-acquired *Leishmania* infection (including, but not limited to, the other persons infected with parasites in the *L. donovani* species complex) developed skin lesions (cutaneous leishmaniasis), with or without associated lymphadenopathy.^{1,2} One of the individuals who developed cutaneous leishmaniasis ultimately developed mucosal leishmaniasis as a sequela. In this instance, the etiologic agent was *L. amazonensis*, a species found in parts of South America. Overall, the exposure routes for the reported laboratory-associated cases of *Leishmania* infection have included accidental needlestick injuries, preexisting non-intact skin, mucosal contact, and the bite of an infected sand fly in an insectary.¹

Occupationally-acquired *Plasmodium* infection may be associated with clinical manifestations such as fever, chills, fatigue, and hemolytic anemia. Malaria may be severe and life-threatening, particularly if caused by *P. falciparum*. Mosquito-transmitted (sporozoite-induced) *Plasmodium* infections have been

documented repeatedly in laboratory settings.¹ The other reported cases of occupationally-acquired *Plasmodium* infection have occurred in persons (including healthcare workers) who had accidental sharps injuries or exposures of non-intact skin.^{1,2}

Laboratory-associated *T. gondii* infection may range from asymptomatic to relatively mild (e.g., flu-like symptoms, rash, lymphadenopathy) to life-threatening (e.g., myocarditis and encephalitis). Laboratorians have become infected with *T. gondii* via ingestion of sporulated oocysts from feline fecal specimens, as well as via percutaneous (e.g., through needlestick injuries or non-intact skin) or mucosal contact with tachyzoites or bradyzoites from human or animal specimens (e.g., peritoneal fluid from experimentally infected rodents) or cultures.^{1,2}

The clinical manifestations of the acute phase of *T. cruzi* infection may include swelling and redness at the site of exposure, fever, rash, and lymphadenopathy. Life-threatening myocarditis and meningoencephalitis may develop. Approximately 20% to 30% of chronically infected persons ultimately develop clinical manifestations, typically cardiac and less often gastrointestinal (megaesophagus or megacolon). Laboratorians have become infected with *T. cruzi* via percutaneous or mucosal exposures, such as to blood from experimentally infected animals or to feces from infected triatomine bugs.

Infection with *T. b. rhodesiense* (East African) and *T. b. gambiense* (West African), which are vector-borne in nature (see below), may cause swelling and redness at the site of exposure, as well as various clinical manifestations during the hemolymphatic stage of the infection. East African trypanosomiasis typically is associated with a more acute course than the West African form, with early invasion of the central nervous system (CNS). After the parasite (of either subspecies) invades the CNS, the infection typically is fatal unless treated. Laboratorians have become infected with *T. brucei* subsp. through sharps injuries or non-intact skin.^{1,2}

Various genera/species of microsporidia found naturally in non-human animals can cause extraintestinal infection in humans. Tissue tropisms vary by genus/species and also may be affected by host factors. Spores (i.e., the infective form) of microsporidia are hardy and can survive for long periods in the environment; ingestion is the primary route of transmission in nature, whereas other exposure routes could cause infection in laboratory settings. The one reported laboratory-associated case of microsporidiosis—a case of keratoconjunctivitis without systemic symptoms—occurred in an immunocompetent laboratorian who was accidentally exposed to *Encephalitozoon cuniculi* “when several drops of culture supernatant containing several million spores were spilled into both eyes.”⁸

No laboratory-associated cases of intramuscular sarcocystosis have been reported. However, humans who ingest fecally shed oocysts or sporocysts of

Sarcocystis nesbitti or of various unidentified *Sarcocystis* spp. with unknown carnivorous definitive hosts may develop intramuscular cysts.⁹

Babesia microti and other *Babesia* spp., which can cause human babesiosis (piroplasmosis), are transmitted in nature by the bite of an infected tick. Although no laboratory-associated cases of *Babesia* infection have been reported, such cases could be acquired through percutaneous contact with contaminated blood from infected persons or animals or, for culturable *Babesia* spp., with cultured parasites. Bites from naturally or experimentally infected ticks may also pose a risk.

Among the free-living amebae (FLA), *Naegleria fowleri* causes primary amebic meningitis, which typically progresses rapidly and causes death, whereas *Acanthamoeba* spp., *B. mandrillaris*, and *S. pedata* may cause granulomatous amebic encephalitis, which typically is more subacute or chronic. FLA may also cause disfiguring skin lesions (*Acanthamoeba* spp. and *B. mandrillaris*) and potentially blinding keratoconjunctivitis, particularly in association with the use of contact lenses or the presence of corneal abrasions (*Acanthamoeba* spp.). No laboratory-associated cases of infection with FLA have been reported. However, potentially infective stages of FLA may be found in tissue, cerebrospinal fluid, and other types of specimens from infected persons and in laboratory cultures of the organisms.

Natural Modes of Infection

Leishmania spp., *Plasmodium* spp., and American and African trypanosomes are transmitted in nature by blood-sucking insects. Sandflies in the genera *Phlebotomus* and *Lutzomyia* transmit *Leishmania* spp.; mosquitoes in the genus *Anopheles* transmit *Plasmodium* spp.; triatomine bugs, including *Triatoma*, *Rhodnius*, and *Panstrongylus* spp., transmit *T. cruzi*, which is found in the feces rather than the saliva of the bugs; tsetse flies in the genus *Glossina* transmit African trypanosomes; and ixodid (hard) ticks transmit *Babesia* spp.

Malaria is widely distributed in the tropics, although the prevalence and incidence rates of *Plasmodium* infection vary in and among areas of endemicity. In aggregate, seven *Plasmodium* spp. have been documented to infect humans in nature, primarily *P. falciparum*, *P. vivax*, *P. ovale*, and *P. malariae* but also the simian species *P. knowlesi*, *P. cynomolgi*, and *P. simium*.

Leishmaniasis is endemic in parts of the tropics, subtropics, and southern Europe. Many *Leishmania* spp. are zoonotic (e.g., have rodent or canine reservoir hosts); however, infected humans serve as epidemiologically important reservoir hosts in some settings for some species, including *L. donovani* and *L. tropica*. Only cats and other felines can serve as definitive hosts for *T. gondii*, which is found worldwide. Birds and mammals, including sheep, pigs, rodents, cattle, deer, and humans, can become infected via ingestion of tissue cysts or mature

(sporulated) fecal oocysts and subsequently develop tissue cysts (e.g., in skeletal muscle, myocardium, brain, eyes). Chagas disease is endemic in Mexico, Central America, and South America; sporadic vector-borne cases also occur in focal areas of the southern United States. Various domestic and wild mammals are found naturally infected with *T. cruzi*. African trypanosomiasis is endemic in sub-Saharan Africa but is highly focal in its distribution. *T. b. gambiense* occurs in parts of western and central Africa, whereas *T. b. rhodesiense* occurs in parts of eastern and southern Africa. *T. b. rhodesiense* is a zoonotic infection with cattle or, in a more limited role, game animals serving as reservoir hosts, whereas humans are the only epidemiologically important hosts for *T. b. gambiense*. *Babesia* infections are found worldwide in animals, and multiple *Babesia* spp. have been documented to infect humans; examples of animal reservoir hosts include white-footed mice (*Peromyscus leucopus*) and other small mammals for *B. microti* and cattle for *B. divergens*.

Laboratory Safety and Containment Recommendations

BSL-2 and ABSL-2 practices, including containment equipment/facilities and laboratory personal protective equipment (PPE), are recommended for activities involving infective stages of the parasites discussed in this section.

Depending in part on the parasite and the phase of the infection, infective stages of blood and tissue protozoa may be present in blood and various body fluids and tissue specimens, including in cultures and homogenates, from infected humans and from experimentally or naturally infected animals, including arthropod vectors if pertinent. See above regarding the primary laboratory hazards. The risks for accidental exposures and occupationally-acquired infections in persons working with cultures, tissue homogenates, blood, or other specimens that contain any of the organisms discussed here, including during procedures that might create aerosols or droplets, should be reduced by use of PPE (e.g., long-sleeved laboratory coat/gown, gloves, face shield, sturdy closed footwear, clothing that covers exposed legs), in conjunction with containment in a biosafety cabinet (BSC). For work with infected arthropod vectors, the prevention measures include using the relevant PPE, as well as maintaining and transporting vectors in facilities or transport containers that reasonably preclude the exposure of personnel or the escape of the arthropods. See [Appendix E](#) for additional information.

Special Issues

Transfer of Agent Importation of any of these agents requires CDC and/or USDA importation permits. Domestic transport of these agents may require a permit from USDA APHIS VS. A Department of Commerce (DoC) permit may be required for the export of these agents to another country. See [Appendix C](#) for additional information.

Intestinal Protozoal Parasites

Intestinal protozoal parasites that pose an occupational risk include *Cryptosporidium* spp., which cause cryptosporidiosis; *Cyclospora cayetanensis*, which causes cyclosporiasis; *Cystoisospora belli*, which causes cystoisosporiasis; *Entamoeba histolytica*, which causes intestinal and extraintestinal (e.g., liver abscess) amebiasis; *Giardia duodenalis*, which causes giardiasis; and *Sarcocystis* hominis (from beef) and *S. suis* (from pork), which cause intestinal sarcocystosis⁹ (see above regarding *Sarcocystis* spp. that can cause intramuscular sarcocystosis). *Dientamoeba fragilis* (for which a cyst stage recently was identified)¹⁰ and *Blastocystis* spp.¹¹ are additional intestinal protozoal parasites that may pose risk to laboratory workers, although their pathogenic potentials in humans continue to be debated.^{10,12} Multiple genera/species of microsporidia (now classified as fungi) can cause intestinal microsporidiosis in humans.

Occupational Infections

Laboratory-associated infections with *Cryptosporidium* spp., *E. histolytica*, *G. duodenalis*, and *C. belli* have been reported.¹⁻³ The reported cases typically have been associated with ingestion of the parasite and, if symptomatic, with gastrointestinal symptoms. Laboratory work that does or may entail exposure to *Cryptosporidium* oocysts warrants special care. Occupationally-acquired infections have occurred quite commonly in personnel working with this agent, especially if infected calves were the source of the oocysts.^{1,2} Other infected animals pose potential risks as well. Circumstantial evidence suggests that airborne transmission of oocysts via droplets of this small organism (i.e., 4–6 µm in diameter) might occur.^{1,2} Rigid adherence to protocol (see below) should reduce the risks for accidental exposures and occupationally-acquired infections in laboratory and animal care personnel.

Natural Modes of Infection

All of these intestinal protozoa have cosmopolitan distributions. In nature, the primary route of transmission is ingestion of an environmentally hardy oocyst (for the coccidia), cyst (for *E. histolytica* and *G. duodenalis*), or spore for the microsporidia. The ID₅₀ has been best established for the zoonotic species *Cryptosporidium parvum*: the reported ID₅₀ has ranged from 12 to 2,066 ingested oocysts, depending on the strain tested;¹³ and the ID₅₀ for one strain of *C. hominis* ranged from 10 to 83 oocysts.¹⁴ Because intestinal protozoa multiply in the host, ingestion of even small inocula could cause infection and illness. The role, if any, for non-human reservoir hosts differs among the intestinal protozoa. Cattle, other mammals, and birds can be infected with various *Cryptosporidium* spp.

Humans are the primary hosts for *E. histolytica* and *C. belli* and are the only established hosts for *C. cayetanensis*. Most human cases of *G. duodenalis* infection likely are acquired via direct or indirect human-to-human transmission,

although zoonotic transmission may rarely occur, particularly from companion cats and dogs. The parasites discussed in this paragraph do not require more than one host to complete their life cycle.

Laboratory Safety and Containment Recommendations

BSL-2 and ABSL-2 practices, including containment equipment/facilities and laboratory personal protective equipment (PPE), are recommended for activities involving infective stages of the parasites discussed in this section.

Depending on the organism, infective stages of these parasites and of microsporidia may be present in the feces and/or in other body fluids (e.g., bile) and tissues. Appropriate standard precautions are recommended, with special attention to personal hygiene (e.g., handwashing), the use of PPE, and laboratory practices that reduce the risk for accidental ingestion of these organisms. Use of a BSC and/or face shield should also reduce the possibility of airborne transmission via contaminated droplets (e.g., when working with liquid suspensions of *Cryptosporidium* oocysts). *Cryptosporidium* oocysts are infectious when shed in stool because they have already fully sporulated and do not require further development outside the host; the oocysts are often present in high numbers in stool and are environmentally hardy. In contrast, the oocysts of *Cystoisospora belli* and *Cyclospora cayetanensis* require an extrinsic maturation period to become infective, which, under favorable environmental conditions, may be relatively short (potentially, <24 hours) for *C. belli* but is quite long (typically, at least 1–2 weeks) for *C. cayetanensis*.

For disinfection of contaminated surfaces (e.g., benchtops and equipment), commercially available iodine-containing disinfectants are effective against *E. histolytica* and *G. duodenalis*, when used as directed, as are high concentrations of chlorine (one cup of full-strength commercial bleach [~5% chlorine] per gallon of water [1:16, vol/vol]).^{1,2} Because undiluted 3% (10 volumes) commercial hydrogen peroxide is known to kill *Cryptosporidium* oocysts after a sufficiently long contact time (data for *Cystoisospora* and *Cyclospora* oocysts are not available), the following approach can be used to decontaminate a surface affected by a laboratory spill containing *Cryptosporidium* oocysts.¹ After removing organic material from the contaminated surface (e.g., by using a conventional laboratory detergent/cleaner) and absorbing the bulk of the spill with disposable paper towels, flood and completely cover the surface with undiluted hydrogen peroxide. Dispense hydrogen peroxide repeatedly, as needed, to keep affected surfaces covered and wet/moist for approximately 30 minutes. Absorb residual hydrogen peroxide with disposable paper towels, and allow surfaces to dry thoroughly (10 to 30 minutes) before use. Care should be taken to autoclave or similarly disinfect all paper towel litter and other disposable materials before disposal. Reusable laboratory items can be disinfected and washed in a laboratory dishwasher by using the sanitize cycle and a detergent containing

chlorine. Alternatively, contaminated items may be immersed for approximately one hour in a water bath preheated to 50°C and washed thereafter in a detergent/disinfectant solution.

Special Issues

Transfer of Agent Importation of any of these agents requires CDC and/or USDA importation permits. Domestic transport of these agents may require a permit from USDA APHIS VS. A Department of Commerce (DoC) permit may be required for the export of these agents to another country. See [Appendix C](#) for additional information.

Cestode Parasites

Cestode parasites that pose an occupational risk include *Echinococcus* spp., *Hymenolepis (Rodentolepis) nana*, and *Taenia solium*. Echinococcosis is caused by cestodes in the genus *Echinococcus*: *E. granulosus* causes cystic echinococcosis, *E. multilocularis* causes alveolar echinococcosis, and *E. vogeli* and *E. oligarthrus* cause polycystic echinococcosis. Humans serve as intermediate hosts and harbor the metacestode or larval stage, which produces a hydatid cyst. *Hymenolepis nana*, the dwarf tapeworm, is cosmopolitan in distribution and causes hymenolepiasis, which is intestinal infection with the adult tapeworm. *Taenia solium*, the pork tapeworm, causes *taeniasis*, which is the infection of the intestinal tract with the adult worm, and cysticercosis, which is the development of larval/tissue cysts (i.e., cysticerci) in various parts of the body, such as brain and subcutaneous tissue.

Occupational Infections

No Laboratory-associated infections with any cestode parasite have been reported.

Natural Modes of Infection

H. nana may act as a one-host parasite and does not require maturation in an intermediate host. *H. nana* is directly transmissible by ingestion of eggs shed in the feces of definitive hosts (i.e., infected humans or rodents). The life cycles of *Echinococcus* and *Taenia* spp. require two hosts. Canids, including dogs, wolves, foxes, coyotes, and jackals, serve as definitive hosts for *E. granulosus*; and various herbivores, such as sheep, cattle, deer, and horses, serve as intermediate hosts. Foxes and coyotes are the principal definitive hosts for *E. multilocularis*, although various canids and felids also can become infected. Rodents serve as intermediate hosts. Bush dogs and pacas serve as the definitive and intermediate hosts, respectively, for *E. vogeli*. Dogs also may be infected. Wild felines, including cougars, jaguarondi, jaguars, ocelots, and pampas cats, are the definitive hosts for *E. oligarthrus*. Various rodents, such as agoutis, pacas, spiny rats, and rabbits, serve as intermediate hosts. Humans become infected with

Echinococcus spp. when eggs shed by definitive hosts are accidentally ingested. For *T. solium*, humans serve as definitive hosts (i.e., harbor the adult tapeworm) but also may serve as accidental intermediate hosts (i.e., harbor cysticerci, larval/tissue cysts). Pigs, which are the usual intermediate hosts, become infected as they scavenge human stool that contains *T. solium* eggs.

Laboratory Safety and Containment Recommendations

Infective eggs of *Echinococcus* spp. may be present in the feces of carnivore definitive hosts.⁴ *E. granulosus* poses the greatest risk because it is the most common and widely distributed *Echinococcus* sp. and because dogs are the primary definitive hosts. For *T. solium*, infective eggs in the feces of humans serve as the source of infection; accidental ingestion of infective eggs is the primary laboratory hazard. Ingestion of cysticerci of *T. solium* or *Taenia asiatica* in pork and *T. saginata* in beef could cause human intestinal infection with the adult tapeworm. Ingestion of the eggs of *H. nana* shed in the feces of definitive hosts (humans or rodents) could result in intestinal infection.

Although no Laboratory-associated infections with *Echinococcus* spp. or *T. solium* have been reported, the consequences of such infections could be serious. For echinococcal infections, the severity and nature of the signs and symptoms, if any, depend in part on the location of the cysts, their size, and condition (alive vs. dead). Clinical manifestations associated with a liver cyst could include hepatosplenomegaly, abdominal pain, and nausea, whereas a lung cyst may cause chest pain, dyspnea, and hemoptysis. For *T. solium*, ingestion of eggs from human feces can result in cysticercosis. Subcutaneous or intramuscular *T. solium* cysts may be asymptomatic; although cysts in the CNS also may be asymptomatic, they may cause seizures and other neurologic manifestations.

For laboratory work with infective stages of the cestode parasites discussed here, BSL-2 and ABSL-2 practices, including containment equipment/facilities and laboratory personal protective equipment (PPE), are recommended, with special attention to personal hygiene (e.g., handwashing), the use of PPE, and laboratory practices that reduce the risk for accidental ingestion of infective eggs. For example, gloves should be worn when there may be direct contact with feces or with surfaces contaminated with fresh feces either from carnivores potentially infected with *Echinococcus* spp., humans potentially infected with *T. solium*, or humans or rodents potentially infected with *H. nana*.

Special Issues

Transfer of Agent Importation of any of these agents requires CDC and/or USDA importation permits. Domestic transport of these agents may require a permit from USDA APHIS VS. A Department of Commerce (DoC) permit may be required for the export of these agents to another country. See [Appendix C](#) for additional information.

Trematode Parasites

The trematode parasites that pose the greatest occupational risk are the *Schistosoma* spp., although others, including *Fasciola* spp., are of concern. *Schistosoma mansoni* causes intestinal schistosomiasis. The adult flukes typically reside in the venules of the bowel and rectum. *Fasciola hepatica*, the sheep liver fluke, causes fascioliasis, in which the adult flukes live in the bile ducts of the human or animal host.

Occupational Infections

Laboratory-associated infections with *S. mansoni* and *F. hepatica* (one possible such case) have been reported, but accidental infections with other *Schistosoma* spp. could also occur.^{1,2} Laboratory-associated infections with *F. hepatica* may be asymptomatic or associated with various clinical manifestations, such as right upper quadrant pain, depending in part on the phase of the infection. Most laboratory exposures to schistosomes would result in low worm and egg burdens, with low-risk for long-term morbidity, although acute infection may be associated with clinical manifestations (e.g., dermatitis, fever, cough, hepatosplenomegaly, lymphadenopathy).

Natural Modes of Infection

F. hepatica has a cosmopolitan distribution and is most common in sheep-raising areas; other natural hosts include goats, cattle, hogs, deer, and rodents. Snails in the family *Lymnaeidae*, primarily species of *Lymnaea*, serve as intermediate hosts for *F. hepatica* and release cercariae that encyst on vegetation. Humans become infected with *F. hepatica* by eating raw or inadequately cooked vegetation, especially green leafy plants, such as watercress, on which metacercariae have encysted. The same route of transmission is applicable to *Fasciola gigantica* (giant liver fluke) and *Fasciolopsis buski* (an intestinal fluke). Infection with other trematodes requires consumption of the infected intermediate host (mainly fish or crustaceans); therefore, the laboratory risk posed by these pathogens is minimal if appropriate standard precautions are followed, including the use of PPE.

S. mansoni is endemic in parts of Africa, South America, and the Caribbean. Free-swimming cercariae in contaminated bodies of water infect humans via skin penetration. The natural snail hosts capable of supporting development of *S. mansoni* are various species of *Biomphalaria*.

Laboratory Safety and Containment Recommendations

Infective stages of *F. hepatica* (metacercariae) and *S. mansoni* (cercariae) may be found, respectively, encysted on aquatic plants or free-living in the water in laboratory aquaria used to maintain snail intermediate hosts. Ingestion of fluke metacercariae and skin penetration by schistosome cercariae are the primary laboratory hazards. Dissection or crushing of schistosome-infected snails may

also result in exposure of skin or mucous membranes to cercariae-containing droplets. Additionally, metacercariae may be inadvertently transferred from hand to mouth by fingers or gloves, following contact with contaminated aquatic vegetation or aquaria.

All of the reported cases of laboratory-associated schistosomiasis have been caused by *S. mansoni*, which probably in part reflects the fact that a laboratory life cycle for *S. mansoni* can be maintained using mice, which is not possible for the other *Schistosoma* spp. However, accidental infection with *S. haematobium*, *S. japonicum*, *S. mekongi*, *S. intercalatum*, or *S. guineensis* could easily occur via transdermal penetration if infected snail intermediate hosts are kept in aquaria or if laboratorians work with water samples that contain infective cercariae. In addition, exposure to cercariae of non-human (e.g., avian) species of schistosomes may cause mild-to-severe dermatitis (i.e., swimmer's itch).

BSL-2 and ABSL-2 practices, including appropriate PPE and containment equipment/facilities, are recommended for laboratory work with infective stages of the trematode parasites discussed here (i.e., when there may be direct contact with water containing cercariae or vegetation with encysted metacercariae from naturally or experimentally infected snail intermediate hosts). For example, in addition to gloves, long-sleeved laboratory coats and face shields or other protective garb should be worn when working in the immediate area of aquaria or other water sources that may contain schistosome cercariae. Cercariae can be killed on contact with 70% ethanol.¹⁵ Therefore, precautionary measures include having squirt bottles that contain 70% ethanol as well as bottles that contain hand sanitizers for which alcohol is the active ingredient strategically placed around the laboratory to facilitate immediate access after accidental spills/exposures.¹⁵ Various approaches (e.g., ethanol, bleach, heat) can be used to kill snails and cercariae in the water of laboratory aquaria before discharge to sanitary sewers. For example, heating the water to $\geq 50^{\circ}\text{C}$ will kill the cercariae within seconds.¹⁵

Special Issues

Transfer of Agent Importation of any of these agents requires CDC and/or USDA importation permits. Domestic transport of these agents may require a permit from USDA APHIS VS. A Department of Commerce (DoC) permit may be required for the export of these agents to another country. See [Appendix C](#) for additional information.

Nematode Parasites

Nematode parasites that pose an occupational risk include the ascarids; *Strongyloides stercoralis*; hookworms (both human and animal); *Enterobius vermicularis* (human pinworm); and the human filariae, primarily *Wuchereria bancrofti* and *Brugia* spp. Three hookworm species cause patent disease in humans: *Necator americanus*, *Ancylostoma duodenale*, and *Ancylostoma ceylanicum* (which also

causes patent disease in cats and dogs). *Ancylostoma braziliense*, *A. caninum*, and *Uncinaria stenocephala* cause hookworm infection in cats and dogs and can also cause cutaneous larva migrans in humans. *Ascaris lumbricoides* causes ascariasis in humans and pigs. *Baylisascaris procyonis* (a parasite of raccoons), *Toxocara canis* (dog reservoir), and *Toxocara cati* (cat reservoir) cause visceral, ocular, and neural larva migrans in humans. Larval anisakid nematodes (in fish and squid) cause anisakiasis. *Trichuris trichiura* (whipworm) causes trichuriasis in humans. *E. vermicularis* (pinworm; humans only) causes enterobiasis (oxyuriasis). *S. stercoralis* (humans and dogs) causes strongyloidiasis; animal *Strongyloides* spp. may cause cutaneous larva migrans. *Angiostrongylus cantonensis* causes eosinophilic meningitis, and *Trichinella* spp. cause trichinellosis.

Occupational Infections

Laboratory-associated infections with human hookworms, *A. lumbricoides*, *E. vermicularis*, and *Strongyloides stercoralis* have been reported.¹⁻³ Laboratory infections with hookworm and *Strongyloides* spp. presumptively acquired from infected animals have also been reported.¹⁻³ Allergic reactions to various antigenic components of human and animal ascarids and anisakids from fish (e.g., aerosolized antigens) may pose risk to sensitized persons.

Laboratory-associated infections with these nematodes may be asymptomatic or associated with a range of clinical manifestations, depending in part on the parasite species and the location(s) of the parasite in the host. The clinical manifestations of infection with *A. lumbricoides* may include cough, fever, and pneumonitis as larvae migrate through the lungs; the larvae develop into adult worms in the small intestine. Infection with *E. vermicularis* usually causes perianal pruritus, with intense itching.

Natural Modes of Infection

Human hookworm and *S. stercoralis* infections are acquired via transdermal penetration of the skin by infective filariform larvae. These nematodes are commonly found in tropical and subtropical regions of the world and cause infection in the small intestine. In contrast to hookworms, *S. stercoralis* is autoinfective and infection may be lifelong if untreated. Intradermal migration of *S. stercoralis* larvae can be associated with a rapidly moving, serpiginous, pruritic eruption referred to as larva currens (“racing” or “running” larva). The time required for *Strongyloides* larvae passed in stool to develop into infective filariform larvae may be as short as approximately two days (i.e., 48 hours); the time required for hookworm larvae to become infective may be as short as three days.

Human cutaneous larva migrans (creeping eruption) occurs when infective larvae of animal hookworms (typically dog and cat hookworms) or of animal *Strongyloides* spp. penetrate the skin and begin wandering. Hookworm infections in dogs and cats and *Strongyloides* spp. infections in animals are endemic worldwide.

A. caninum larvae can also cause infection if ingested. On rare occasions, ingested *A. caninum* larvae have developed into non-gravid adult worms in the human gut, leading to eosinophilic enteritis.

A. lumbricoides and *T. trichiura* infections are endemic in tropical and subtropical regions of the world. *T. canis* and *T. cati* are found worldwide in dogs and cats, respectively. *B. procyonis* is found primarily in raccoons but may also infect dogs. All of these parasites are transmitted via ingestion of embryonated (larvated) eggs. Unembryonated eggs passed in the stool require 2–3 weeks to larvate and become infectious. The eggs are very hardy in the environment and are resistant to most disinfectants (see below).

E. vermicularis is found worldwide, but pinworm infection tends to be more common in school-age children than adults and in temperate than tropical regions. Pinworm infection is acquired by ingestion of eggs (e.g., eggs on contaminated fingers after scratching the perianal skin). Eggs passed by female worms are not immediately infective but require only several hours to become fully infectious. Pinworm infection is of relatively short duration (approximately 60 days on average) unless reinfection occurs.

Some anisakid larvae (*Anisakis* spp., *Pseudoterranova decipiens*, and *Contracaecum* spp.) are infective to humans via ingestion. The larvae may be coughed up, be vomited, or form eosinophilic granulomas in the gastrointestinal tract. These nematodes also are antigenic and may cause immediate hypersensitivity reactions (e.g., urticaria, anaphylaxis) when infected fish are ingested.

Laboratory Safety and Containment Recommendations

Eggs and larvae of most nematodes are not infective in freshly passed feces; development to the infective stages may require from less than one day to several weeks, depending in part on the genus/species and the environmental conditions. Ingestion of infective eggs or transdermal penetration by infective larvae are the primary hazards to laboratory staff and animal care personnel.

To minimize the risk for transdermal penetration when working with cultures or fecal specimens that may contain infective hookworm or *Strongyloides* spp. larvae, PPE should be used to cover exposed skin. In an investigation in which *S. stercoralis*-positive stool specimens were reexamined after they had been stored at 4°C for 24, 48, and 72 hours, 23% of the 74 specimens examined still had viable larvae after refrigeration for 72 hours.¹⁶ The following iodine concentrations have been shown to kill infective larvae immersed in an aqueous iodine solution for one to five minutes: 50 ppm iodine for *S. stercoralis* larvae, 60 ppm for *N. americanus* (hookworm) larvae, and 70 ppm for *A. caninum* (hookworm) larvae.¹⁷ In vitro exposure to 70% ethanol has been shown to kill infective *S. stercoralis* larvae within 4.3 ± 1 minutes (mean \pm standard deviation).¹⁸ In vitro exposure to 70% ethanol has been shown to kill 95.6% of 45 infective

N. americanus larvae within five minutes and to kill all such larvae within 10 minutes.¹⁹ Taking into consideration the data summarized in this paragraph, Lugol's iodine (1% povidine iodine; 10,000 ppm) may be used to kill *N. americanus* and *S. stercoralis* infective larvae on exposed skin and 70% ethanol (which leaves far less residue on surfaces) may be used to disinfect contaminated laboratory surfaces and equipment.

Ascarid (*A. lumbricoides*, *Toxocara* spp., *B. procyonis*) and *E. vermicularis* eggs are sticky; special care is warranted to ensure that contaminated surfaces and equipment are thoroughly cleaned. Precautions are warranted even when working with formalin-fixed stool specimens. Ascarid eggs, which are exceptionally environmentally resistant, may continue to develop to the infective stage in formalin;²⁰ they also may continue to develop despite exposure to high concentrations of disinfectants for long periods. However, ascarid eggs can be deactivated by the use of heat at or above 60°C for more than 15 minutes.

Accidental ingestion of larvated (infectious) eggs of *Toxocara* and *B. procyonis* could lead to visceral migration of larvae, including invasion of the eyes and CNS. The larvae of *Trichinella* in fresh or digested animal tissue, or of *A. cantonensis* in fresh or digested mollusk tissue, could cause infection if accidentally ingested. Vector arthropods infected with filarial parasites pose a potential hazard to laboratory personnel. The prevention measures include using the relevant PPE (e.g., gowns, gloves, closed shoes); maintaining and transporting vectors in facilities or transport containers that reasonably preclude the exposure of personnel or the escape of infected arthropods are also essential. See [Appendix E](#) for additional information.

The use of primary containment (e.g., BSC) during work that may be associated with aerosolization should reduce the potential for exposure to aerosolized antigens of ascarids and anisakids, which can cause allergic reactions in sensitized persons. Special attention to use of PPE and to personal hygiene (e.g., handwashing) is warranted when working with any of the nematode pathogens discussed here.

Special Issues

Transfer of Agent Importation of any of these agents requires CDC and/or USDA importation permits. Domestic transport of these agents may require a permit from USDA APHIS VS. A Department of Commerce (DoC) permit may be required for the export of these agents to another country. See [Appendix C](#) for additional information.

References

1. Herwaldt BL. Protozoa and helminths. In: Wooley DP, Byers KB, editors. *Biological Safety: Principles and Practices*. 5th ed. Washington (DC): ASM Press; 2017. p. 105–45.
2. Herwaldt BL. Laboratory-acquired parasitic infections from accidental exposures. *Clin Microbiol Rev*. 2001;14(4):659–88.
3. Pike RM. Laboratory-associated infections: summary and analysis of 3921 cases. *Health Lab Sci*. 1976;13(2):105–14.
4. Hankenson FC, Johnston NA, Weigler BJ, Di Giacomo RF. Zoonoses of occupational health importance in contemporary laboratory animal research. *Comp Med*. 2003;53(6):579–601.
5. Wendel S, Leiby DA. Parasitic infections in the blood supply: assessing and countering the threat. *Dev Biol (Basel)*. 2007;127:17–41.
6. Schwartz BS, Mawhorter SD; AST Infectious Diseases Community of Practice. Parasitic infections in solid organ transplantation. *Am J Transplant*. 2013;13 Suppl 4:280–303.
7. Carlier Y, Truyens C, Deloron P, Peyron F. Congenital parasitic infections: a review. *Acta Trop*. 2012;121(2):55–70.
8. van Gool T, Biderre C, Delbac F, Wentink-Bonnema E, Peek R, Vivares CP. Serodiagnostic studies in an immunocompetent individual infected with *Encephalitozoon cuniculi*. *J Infect Dis*. 2004;189(12):2243–9.
9. Fayer R, Esposito DH, Dubey JP. Human infections with *Sarcocystis* species. *Clin Microbiol Rev*. 2015;28(2):295–311.
10. Stark D, Barratt J, Chan D, Ellis JT. *Dientamoeba fragilis*, the neglected trichomonad of the human bowel. *Clin Microbiol Rev*. 2016;29(3):553–80.
11. Rajah Salim H, Suresh Kumar G, Vellayan S, Mak JW, Khairul Anuar A, Init I, et al. *Blastocystis* in animal handlers. *Parasitol Res*. 1999;85(12):1032–3.
12. Roberts T, Stark D, Harkness J, Ellis J. Update on the pathogenic potential and treatment options for *Blastocystis* sp. *Gut Pathog*. 2014;6:17.
13. Messner MJ, Chappell CL, Okhuysen PC. Risk assessment for *Cryptosporidium*: a hierarchical Bayesian analysis of human dose response data. *Water Res*. 2001;35(16):3934–40.
14. Chappell CL, Okhuysen PC, Langer-Curry R, Widmer G, Akiyoshi DE, Tanriverdi S, et al. *Cryptosporidium hominis*: experimental challenge of healthy adults. *Am J Trop Med Hyg*. 2006;75(5):851–7.
15. Tucker MS, Karunaratne LB, Lewis FA, Freitas TC, Liang YS. Schistosomiasis. *Curr Protoc Immunol*. 2013;103:Unit 19.1.1–19.1.58.
16. Inês Ede J, Souza JN, Santos RC, Souze ES, Santos FL, Silva ML, et al. Efficacy of parasitological methods for the diagnosis of *Strongyloides*

stercoralis and hookworm in faecal specimens. *Acta Trop.* 2011;120(3): 206–10.

17. Thitasut P. Action of aqueous solutions of iodine on fresh vegetables and on the infective stages of some common intestinal nematodes. *Am J Trop Med Hyg.* 1961;10:39–43.
18. Hirata T, Kishimoto K, Uchima N, Kinjo N, Hokama A, Kinjo F, et al. Efficacy of high-level disinfectants for gastrointestinal endoscope disinfection against *Strongyloides stercoralis*. *Digestive Endoscopy.* 2006;18:269–71.
19. Speare R, Melrose W, Cooke S, Croese J. Techniques to kill infective larvae of human hookworm *Necator americanus* in the laboratory and a new Material Safety Data Sheet. *Aust J Med Sci.* 2008;29(3):91–6.
20. Ash LR, Orihel TC. *Parasites: A Guide to Laboratory Procedures and Identification.* Chicago: ASCP Press; 1991.

Section VIII-D: Rickettsial Agents

Coxiella burnetii

Coxiella burnetii is a bacterial obligate intracellular pathogen that is the etiologic agent of Q (query) fever. It undergoes its developmental cycle within an acidic vacuolar compartment, exhibiting many characteristics of a phagolysosome. The biphasic developmental cycle consists of a small cell variant (SCV) and a large cell variant (LCV). The SCV is the more structurally-stable cell variant, persisting for extended periods of time outside of host cells and exhibiting resistance to extracellular stresses (drying, extreme temperatures, environmental conditions). The LCV is the larger, metabolically-active variant, which facilitates replication of the agent.¹⁻⁴ The organism undergoes a virulent (phase I) to avirulent (phase II) transition upon serial laboratory passage in eggs or tissue culture.

The ID of phase I organisms in laboratory animals has been calculated to be as small as a single organism.⁵ The estimated human ID for development of Q fever by inhalation is approximately 10 organisms.⁶ Typically, the disease manifests with flu-like symptoms including fever, headache, and myalgia, but can also present with pneumonia and hepatomegaly. Infections range from subclinical to severe, and primary/acute infections respond readily to antibiotic treatment. Although rare, *C. burnetii* can cause chronic infections such as endocarditis, granulomatous hepatitis, or vascular infections.⁷

Occupational Infections

Q fever is the second most commonly reported Laboratory-associated infection (LAI) in Pike's compilation with outbreaks involving 15 or more persons recorded in several institutions.^{8,9} Infectious aerosols are the most likely route of LAI. Experimentally infected animals may also serve as potential sources of infection for laboratory and animal care personnel. Exposure to naturally infected, often asymptomatic, sheep and their birth products is a documented hazard to personnel.^{10,11}

Natural Modes of Infection

Q fever occurs worldwide. A broad range of domestic and wild mammals are natural hosts for Q fever and may serve as potential sources of infection. Parturient animals and their birth products are common sources of infection. The placenta of infected sheep may contain as many as 10^9 organisms per gram of tissue¹² and milk may contain 10^5 organisms per gram. The resistance of the organism to drying and its low infectious dose can lead to dispersal from contaminated sites. The agent may also be present in infected arthropods, and it may be present in the blood, urine, feces, milk, and tissues of infected animals or human hosts.

Laboratory Safety and Containment Recommendations

Recent advances leading to cell-free media supporting the growth of *C. burnetii*¹³ have greatly reduced the necessity of using embryonated eggs or cell culture techniques for propagation and accompanying extensive purification procedures. Exposure to infectious aerosols and parenteral inoculation remain the most likely sources of infection to laboratory and animal care personnel.^{8,9}

BSL-3 practices and facilities are recommended for activities involving the inoculation, incubation, and harvesting of *C. burnetii*, the necropsy of infected animals, and the manipulation of infected tissues. Because infected rodents may shed the organisms in urine or feces,⁸ experimentally infected animals should be maintained under ABSL-3. A specific plaque-purified clonal isolate of an avirulent (phase II, Nine Mile Strain, plaque purified clone 4) strain is exempt from the Select Agent Regulations and may be safely handled under BSL-2 conditions.¹⁴ BSL-2 practices and facilities are recommended for nonpropagative laboratory procedures, including serological examinations and staining of impression smears.

Special Issues

C. burnetii is among the most environmentally stable of non-spore forming bacteria with a known capacity for extended survival in soil or other contaminated materials, such as animal products, for years.⁴ The ID approaches a single organism,⁵ thus the capacity for airborne or aerosol transmission is high. Infections are frequently asymptomatic, or cause relatively mild, flu-like symptoms, but can be severe. Chronic infections (i.e., endocarditis) are possible, particularly in those with pre-existing valvular damage or immunocompromised individuals. Q fever is a known hazard during pregnancy.¹⁵

Exposure to naturally infected, often asymptomatic, sheep and their birth products is a documented hazard to personnel.^{10,11} Recommended precautions for facilities using sheep as experimental animals are described by Spinelli and Bernard.^{10,16}

Vaccines Q fever vaccines are not commercially available in the United States. Individuals with valvular heart disease should not work with *C. burnetii*. Work with *C. burnetii* should be avoided during pregnancy. See [Section VII](#) for additional information.

Select Agent *C. burnetii* is considered a Select Agent under the Code of Federal Regulations (42 CFR Part 73). All rules concerning the possession, storage, use, and transfer of Select Agents apply. [Appendix F](#) contains additional information on Select Agents, including contact information for registration and obtaining appropriate permits for importing, exporting, or transporting this agent.

Transfer of Agent Importation of this agent requires CDC and/or USDA importation permits. Domestic transport of this agent may require a permit from USDA APHIS VS. A Department of Commerce (DoC) permit may be required for the export of this agent to another country. See [Appendix C](#) for additional information.

Rickettsia species and Orientia tsutsugamushi

Rickettsia prowazekii, *Rickettsia typhi*, the Spotted Fever Group agents of human disease (*Rickettsia rickettsii*, *Rickettsia conorii*, *Rickettsia akari*, *Rickettsia australis*, *Rickettsia sibirica*, and *Rickettsia japonica*), *Orientia tsutsugamushi*, *Rickettsia philipii* (*Rickettsia* 364D), *Rickettsia parkeri*, and various other *Rickettsia* spp. either known as or suspected to be human pathogens of varying pathogenicity are the respective etiologic agents of epidemic typhus, endemic (murine) typhus, Rocky Mountain spotted fever, Mediterranean spotted fever, rickettsialpox, Queensland tick typhus, North Asian spotted fever, Japanese spotted fever, scrub typhus, Pacific Coast tick fever (PCTF), and *Rickettsia parkeri* rickettsiosis.

Rickettsia spp. are bacterial obligate intracellular pathogens that are transmitted by arthropod vectors and replicate within the cytoplasm of eukaryotic host cells. *Rickettsia* spp. are broken into four groups within the genus: the typhus group, the Spotted Fever Group, a transitional group, and an ancestral group.¹⁷ The more distantly related scrub typhus group is now considered a distinct genus, *Orientia*. *Rickettsiae* are primarily associated with arthropod vectors in which they may exist as endosymbionts that infect mammals, including humans, through the bite of infected ticks, lice, fleas, or mites.

Occupational Infections

Although not a natural route of infection, some *Rickettsia* spp. can be infectious by an aerosol route, thus adherence to BSL-3 practices is essential. Parenteral inoculation/needlestick injuries are also among the more common routes of laboratory infection. Infections can also be acquired by conjunctival inoculation.

Pike reported 56 cases of epidemic typhus with three deaths, 68 cases of murine typhus, and 57 cases of laboratory-associated typhus (type not specified).⁸ Three cases of murine typhus were reported from a research facility.¹⁸ Two of these three cases were associated with the handling of infectious materials on the open bench; the third case resulted from an accidental parenteral inoculation.

Rocky Mountain spotted fever (RMSF) is a documented hazard to laboratory personnel. Pike reported 63 laboratory-associated cases, 11 of which were fatal and occurred prior to 1940.⁸ Since that time, two fatalities occurred, in the same facility and presumably from the same exposure, among a laboratory worker and a custodian in 1977. These illnesses were presumed to be employment-related.¹⁹

Oster reported nine cases occurring from 1971 to 1976 in one laboratory, which were believed to have been acquired as a result of exposure to infectious aerosols.²⁰

Natural Modes of Infection

The epidemiology of rickettsial infections is a reflection of the prevalence of the *rickettsiae* in the vector population and the interactions of the arthropod vector with humans. Epidemic typhus is unusual among *rickettsiae* in that humans are considered the primary host. Transmission is by the human body louse, and outbreaks are now associated with breakdowns of social conditions.²¹ Under these conditions, even with appropriate treatment, mortality averaged about 4%.²² Endemic typhus is maintained in rodents and transmitted to humans by fleas. The various spotted fever group *rickettsiae* are limited geographically, probably by the distribution of the arthropod vector (usually ticks), although specific spotted fever group *rickettsiae* are found on all continents.²³

Laboratory Safety and Containment Requirements

Accidental parenteral inoculation and exposure to infectious aerosols are the most likely sources of Laboratory-associated infection.²⁴ Aerosol transmission of *R. rickettsii* has been experimentally documented in non-human primates.²⁵ Five cases of rickettsialpox recorded by Pike were associated with exposure to bites of infected mites.⁸

The tissues of naturally and experimentally infected mammals and their ectoparasites are potential sources of human infection. The organisms are relatively unstable under ambient environmental conditions.

BSL-3 practices and containment equipment are recommended for activities involving culture propagation or specimen preparation and propagation of clinical isolates known to contain or potentially containing *Rickettsia* spp. pathogenic to humans.

Arthropod Containment Level 3 (ACL-3) practices and facilities are recommended for animal studies with arthropods naturally or experimentally infected with rickettsial agents of human disease.²⁶

Laboratory work with *Rickettsia* spp. may be conducted in a BSL-2 facility with enhanced special practices including strict access control, competency, and adherence to BSL-3 practices. Laboratories should be locked and access to non-essential personnel should be prohibited. BSL-3 practices include, but are not limited to, appropriate personal protective equipment (e.g., rear-closing gowns, gloves, eye protection, and respiratory protection such as N95 respirators or PAPRs), use of BSCs when handling any open container with potentially infectious material, and primary containment, such as sealed centrifuge rotors

and other means of containment outside the BSC. Disruption of infected cells or yolk sacs should be accomplished within the BSC using an enclosed chamber to minimize the potential for aerosols. If eggs are used for propagation, the site of inoculation should be sealed with an appropriate sealant prior to transfer to an incubator. BSL-2 facilities with BSL-3 practices are recommended for all manipulations of known or potentially infectious materials, including the necropsy of experimentally infected animals and trituration of their tissues, and inoculation, incubation, and harvesting of embryonated eggs or cell cultures. Use of sharps should be minimized. When use of sharps is necessary, they should be disposed of and decontaminated appropriately. All contaminated materials should be effectively decontaminated before removal from the laboratory. If transport to an autoclave is necessary, materials should be double-bagged.

BSL-2 practices and facilities are recommended for nonpropagative laboratory procedures with inactivated samples, including serological and fluorescent antibody procedures, nucleic acid amplification, and for the staining of impression smears after fixation.

ABSL-2 practices and facilities are recommended for the holding of experimentally infected mammals other than arthropods. Several species including *R. montanensis*, *R. rhipicephali*, *R. bellii*, *R. amblyommatis*, and *R. canadensis* are not known to cause human disease and may be handled under BSL-2 conditions. New species are frequently described and should be evaluated for appropriate containment on a case-by-case basis.

Because of the proven value of antibiotic therapy in the early stages of infection, it is essential that laboratories working with *rickettsiae* have an effective system for reporting febrile illnesses in the laboratory, animal facility, and support personnel; medical evaluation of potential cases; and the institution of appropriate antibiotic therapy when indicated. Prophylactic antibiotic treatment following a potential exposure is discouraged in the absence of clinically compatible signs and symptoms and could delay onset of disease. Vaccines are not currently available for use in humans.

Laboratory Surveillance

Since 1940, only two laboratory fatalities have occurred due to *R. rickettsij*.^{19,27,28} This incident emphasizes the necessity of controlling access to the laboratory and expeditious reporting of any exposure or unexplained illness.

Special Issues

Occupational Health Recommendations Under natural circumstances, the severity of disease caused by rickettsial agents varies considerably.^{23,29} In the laboratory, very large inocula are possible, which might produce unusual and very serious responses. Surveillance of personnel for Laboratory-associated

infections with rickettsial agents can dramatically reduce the risk of serious consequences of disease. See [Section VII](#) for additional information.

Infections adequately treated with specific anti-rickettsial chemotherapy on the first day of disease do not generally present serious problems. However, delay in instituting appropriate chemotherapy may result in debilitating or severe acute disease ranging from increased periods of convalescence in typhus and scrub typhus to death in *R. rickettsii* infections. The key to reducing the severity of disease from LAIs is a reliable surveillance system, which includes:

1. Round-the-clock availability of an experienced medical officer knowledgeable about infectious disease;
2. Education of all personnel on signs and symptoms of disease and the advantages of early therapy;
3. A non-punitive, anonymous reporting system for all recognized accidents; and
4. The reporting of all febrile illnesses, especially those associated with headache, malaise, and prostration when no other certain cause exists.

Select Agent *R. prowazekii* is considered a Select Agent under the Code of Federal Regulations (42 CFR Part 73). All rules concerning the possession, storage, use, and transfer of Select Agents apply. [Appendix F](#) contains additional information on Select Agents, including contact information for registration and obtaining appropriate permits for importing, exporting or transporting this agent.

Transfer of Agent Importation of this agent requires CDC and/or USDA importation permits. Domestic transport of this agent may require a permit from USDA APHIS VS. A Department of Commerce (DoC) permit may be required for the export of this agent to another country. See [Appendix C](#) for additional information.

References

1. Babudieri B. Q fever: a zoonosis. *Adv Vet Sci.* 1959;5:81–182.
2. Ignatovich VF. The course of inactivation of *Rickettsia burnetii* in fluid media. *J Microbiol Epidemiol Immunol.* 1959;30(9):134–41.
3. Sawyer LA, Fishbein DB, McDade JE. Q fever: current concepts. *Rev Infect Dis.* 1987;9(5):935–46.
4. Heinzen RA, Hackstadt T, Samuel JE. Developmental biology of *Coxiella burnetii*. *Trends Microbiol.* 1999;7(4):149–54.
5. Ormsbee R, Peacock M, Gerloff R, Tallent G, Wike D. Limits of rickettsial infectivity. *Infect Immun.* 1978;19(1):239–45.
6. Wedum AG, Barkley WE, Hellman A. Handling of infectious agents. *J Am Vet Med Assoc.* 1972;161(11):1557–67.

7. Maurin M, Raoult D. Q fever. *Clin Microbiol Rev.* 1999;12(4):518–53.
8. Pike RM. Laboratory-associated infections: Summary and analysis of 3921 cases. *Health Lab Sci.* 1976;13(2):105–14.
9. Johnson JE, Kadull PJ. Laboratory-acquired Q fever. A report of fifty cases. *Am J Med.* 1966;41(3):391–403.
10. Spinelli JS, Ascher MS, Brooks DL, Dritz SK, Lewis HA, Morrish RH, et al. Q fever crisis in San Francisco: Controlling a sheep zoonosis in a lab animal facility. *Lab Anim.* 1981:24–7.
11. Meiklejohn G, Reimer LG, Graves PS, Helmick C. Cryptic epidemic of Q fever in a medical school. *J Infect Dis.* 1981;144(2):107–13.
12. Welsh HH, Lennette EH, Abinanti FR, and Winn JF. Q fever in California. IV. Occurrence of *Coxiella burnetii* in the placenta of naturally infected sheep. *Public Health Rep.* 1951;66(45):1473–7.
13. Omsland A, Cockrell DC, Howe D, Fischer ER, Virtaneva K, Sturdevant DE, et al. Host cell-free growth of the Q fever bacterium *Coxiella burnetii*. *Proc Natl Acad Sci U S A.* 2009;106(11):4430–4.
14. Hackstadt T. Biosafety concerns and *Coxiella burnetii* [letter]. *Trends Microbiol.* 1996;4(9):341–2.
15. Eldin C, Melenotte C, Mediannikov O, Ghigo E, Million M, Edouard S, et al. From Q Fever to *Coxiella burnetii* infection: a Paradigm Change. *Clin Microbiol Rev.* 2017;30(1):115–90.
16. Bernard KW, Parham GL, Winkler WG, Helmick CG. Q fever control measures: Recommendations for research of facilities using sheep. *Infect Control.* 1982;3(6):461–5.
17. Gillespie JJ, Williams K, Shukla M, Snyder EE, Nordberg EK, Ceraul SM, et al. *Rickettsia* phylogenomics: unwinding the intricacies of obligate intracellular life. *PLoS One.* 2008;3(4):e2018.
18. Bellanca J, Iannin P, Hamory B, Miner WF, Salaki J, Stek M. Laboratory-acquired endemic typhus—Maryland. *MMWR.* 1978;27(26):215–6.
19. Hazard PB, McCroan JE. Fatal Rocky Mountain Spotted Fever—Georgia. *MMWR.* 1977;26:84.
20. Oster CN, Burke DS, Kenyon RH, Ascher MS, Harber P, Pedersen CE Jr. Laboratory-acquired Rocky Mountain Spotted Fever. The hazard of aerosol transmission. *N Engl J Med.* 1977;297(16):859–63.
21. A large outbreak of epidemic louse-borne typhus in Burundi. *Wkly Epidemiol Rec.* 1997;72(21):152–3.
22. Bechah Y, Capo C, Mege JL, Raoult D. Epidemic typhus. *Lancet Infect Dis.* 2008;8(7):417–26.

23. Richards AL. Worldwide detection and identification of new and old *Rickettsiae* and rickettsial diseases. *FEMS Immunol Med Microbiol*. 2012;64(1):107–10.
24. Hattwick MA, O'Brien RJ, Hanson BF. Rocky Mountain Spotted Fever: epidemiology of an increasing problem. *Ann Intern Med*. 1976;84(6):732–9.
25. Saslaw S, Carlisle HN. Aerosol infection of monkeys with *Rickettsia rickettsii*. *Bacteriol Rev*. 1966;30(3):636–45.
26. Vanlandingham DL, Higgs S, Huang YJS. Arthropod Vector Biocontainment. In: Wooley DP, Byers KB, editors. *Biological Safety Principles and Practices*. 5th ed. Washington (DC): ASM Press; 2017. p. 399–410.
27. Wurtz N, Papa A, Hukic M, Di Caro A, Leparc-Goffart I, Leroy E, et al. Survey of laboratory-acquired infections around the world in Biosafety Level 3 and 4 laboratories. *Eur J Clin Microbiol Infect Dis*. 2016;35(8):1247–58.
28. Harding LH, Byers KB. Laboratory-associated infections. In: Wooley DP, Byers KB, editors. *Biological Safety: Principles and Practices*. 5th ed. Washington (DC): ASM Press; 2017. p. 59–92.
29. Hackstadt T. The biology of *Rickettsiae*. *Infect Agents Dis*. 1996;5(3):127–43.

Section VIII-E: Viral Agents

Hantaviruses

Hantaviruses are negative-sense RNA viruses belonging to the genus *Hanta-virus* within the family *Bunyaviridae*. The natural hosts of hantaviruses are rodent species and they occur worldwide. Hantavirus pulmonary syndrome (HPS) is a severe disease caused by hantaviruses such as Sin Nombre virus or Andes virus whose hosts are rodents in the subfamily *Sigmodontinae*. This subfamily only occurs in the New World, so HPS is not seen outside North and South America. Hantaviruses in Europe and Asia frequently cause kidney disease, called nephropathica epidemica in Europe, and hemorrhagic fever with renal syndrome (HFRS) in Asia. HFRS caused by Seoul or Seoul-like viruses originating from *Rattus* sp. has been described worldwide. Hantaviruses have been recently described worldwide in shrews, but no human disease has been described yet from these viruses.

Occupational Infections

Documented Laboratory-associated infections have occurred in individuals working with hantaviruses.¹⁻⁴ Extreme caution must be used in performing any laboratory operation that may create aerosols (e.g., centrifugation, vortex-mixing). Operations involving rats, voles, and other laboratory rodents should be conducted with special caution because of the extreme hazard of aerosol infection, especially from infected rodent urine.

Natural Modes of Infection

HPS is a severe, often fatal disease that is caused by Sin Nombre and Andes or related viruses.^{5,6} Most cases of human illness have resulted from exposures to naturally infected wild rodents or to their excreta. Human infections and illness (caused by Seoul-like virus) have been reported in Europe and the U.S. in people raising and trading pet rats.^{7,8} Person-to-person transmission does not occur, with the exception of a few rare instances documented, for Andes virus.^{9,10} Arthropod vectors are not known to transmit hantaviruses.

Laboratory Safety and Containment Recommendations

Laboratory transmission of hantaviruses from rodents to humans via the aerosol route is well documented.^{4-6,10} Exposures to rodent excreta, especially aerosolized infectious urine, fresh necropsy material, and animal bedding are presumed to be associated with risk. Other potential routes of laboratory infection include ingestion, contact of infectious materials with mucous membranes or broken skin and, in particular, animal bites. Viral RNA has been detected in necropsy specimens and in patient blood and plasma obtained early in the course of HPS;^{11,12} however, the infectivity of blood or tissues is unknown.

All work involving inoculation of virus-containing material into rodent species permissive for chronic infection should be conducted at ABSL-4. Cell-culture virus propagation and purification should be carried out in a BSL-3 facility using BSL-3 practices, containment equipment, and procedures. Serum or tissue samples from potentially infected rodents should be handled at BSL-2 using BSL-3 practices, containment equipment, and procedures. Potentially infected tissue samples should be handled in BSL-2 facilities following BSL-3 practices and procedures.

BSL-2 practices, containment equipment, and facilities are recommended for laboratory handling of sera from persons potentially infected with hantaviruses. The use of a BSC is recommended for all handling of human body fluids when potential exists for splatter or aerosol. Experimentally infected rodent species known not to excrete the virus can be housed in ABSL-2 facilities using ABSL-2 practices and procedures.

Special Issues

Transfer of Agent Importation of this agent requires CDC and/or USDA importation permits. Domestic transport of this agent may require a permit from USDA APHIS VS. A DoC permit may be required for the export of this agent to another country. See [Appendix C](#) for additional information.

Hendra Virus (formerly known as Equine Morbillivirus) and Nipah Virus

Hendra virus (HeV) and Nipah virus (NiV) are members of the genus called *Henipavirus*, within the family *Paramyxoviridae*.¹³ Outbreaks of a previously unrecognized paramyxovirus, at first called equine morbillivirus, later named Hendra virus, occurred in horses in Australia in 1994 and 1995. From 1994 to 2017, there have been more than 90 confirmed cases of Hendra virus infection in horses in Queensland and in northeast New South Wales. Following contacts with infected horses, four out of the seven human cases described were fatal and associated with encephalitis or respiratory disease. During 1998–1999, an outbreak of illness caused by a similar but distinct virus, now known as Nipah virus, occurred in Malaysia and Singapore. Human illness, characterized by fever, severe headache, myalgia, and signs of encephalitis occurred, in individuals in close contact with infected pigs (i.e., pig farmers and abattoir workers).^{14–16} A few patients developed a respiratory disease. Approximately 40% of cases resulted in fatalities. Following the 1998–1999 outbreak in Malaysia, the WHO Regional Office for South-East Asia reported 16 outbreaks in Bangladesh and India between 2001 and 2012, totaling 263 cases. Person-to-person transmission of Nipah virus in Bangladesh and India are reported regularly. Transmission also occurs from direct exposure to infected bats and through consumption of raw date palm sap contaminated with infectious bat excretions. In 2014, an outbreak of Nipah virus occurred in the Philippines that resulted in deaths of horses and humans. Outbreaks of Nipah in South-East Asia have a strong seasonal pattern,

occurring between December and May, possibly due to bat breeding season or the date palm sap harvesting season.^{17–19} A new henipavirus, Cedar virus, has been isolated from pteropid bats and has significantly reduced virulence in several animal models. The reduced virulence is likely related to alterations found in the P gene, which ablates the production of innate immune antagonist proteins.

Occupational Infections

No Laboratory-associated infections are known to have occurred because of Hendra or Nipah virus exposure. However, people in close contact with Hendra virus-infected horses, especially veterinary professionals (i.e., four cases with two fatalities), are at high risk of contracting the disease.^{20–24}

Natural Modes of Infection

The natural reservoir hosts for the Hendra and Nipah viruses appear to be fruit bats of the genus *Pteropus*.^{25–27} Studies suggest that a locally occurring member of the genus, *Pteropus giganteus*, is the reservoir for the virus in Bangladesh.²⁸ Individuals who had regular contact with bats had no evidence of infection (i.e., antibody) in one study in Australia.²⁹ Human-to-human transmission has been described in familial clusters and associated with close care of severely ill patients.³⁰

Laboratory Safety and Containment Recommendations

The exact mode of transmission of these viruses has not been established. Most clinical cases to date have been associated with close contact with horses, equine blood or body fluids (Australia), or pigs (Malaysia/Singapore), but presumed transmission from *Pteropus* bats to humans via palm date juice has been recorded in Bangladesh. Live virus has been detected in bat urine, implying the important role of urine in transmitting henipaviruses to spillover hosts. Hendra and Nipah viruses have been isolated from tissues of infected animals. In the outbreaks in Malaysia and Singapore, viral antigen was found in central nervous system, kidney, and lung tissues of fatal human cases, and virus was present in secretions of patients, albeit at low levels.^{31,32} Active surveillance for infection of healthcare workers in Malaysia has not detected evidence of Laboratory-associated infections in this setting.³³

Because of the unknown risks to laboratory workers and the potential impact on indigenous livestock, should the virus escape a diagnostic or research laboratory, health officials and laboratory managers should evaluate the need to work with the virus and the containment capability of the facility before undertaking any work with Hendra, Nipah, or suspected related viruses. BSL-4 is required for all work with these viruses. Once a diagnosis of Nipah or Hendra virus is suspected, all diagnostic specimens also must be handled at BSL-4. ABSL-4 is required for any work with infected animals.

Work with Cedar virus in a new animal model should be performed at ABSL-3 until it is demonstrated that the virus does not result in observable illness. Work with Cedar virus in susceptible animal hosts can be performed at ABSL-2 if it has been demonstrated that the virus is avirulent/non-pathogenic and following a risk assessment of the proposed work.

Special Issues

Vaccines Vaccines are not available for use in humans, but Hendra vaccine is available in Australia for horses.

Select Agent Hendra and Nipah virus are Select Agents requiring registration with CDC or USDA for possession, use, storage, and/or transfer. See [Appendix F](#) for additional information.

Transfer of Agent Importation of this agent requires CDC and/or USDA importation permits. Domestic transport of this agent may require a permit from USDA APHIS VS. A DoC permit may be required for the export of this agent to another country. See [Appendix C](#) for additional information.

Hepatitis A Virus, Hepatitis E Virus

Hepatitis A virus (HAV) is a positive-sense single-stranded RNA virus, the type species of the Hepatovirus genus in the family *Picornaviridae*. Hepatitis E virus (HEV) is a positive-sense single-stranded RNA virus of the genus Orthohepevirus in the family *Hepeviridae*. There are four major hepatitis E genotypes that infect humans: genotypes 1, 2, 3, and 4.

Occupational Infections

Laboratory-associated infections with hepatitis A or E viruses do not appear to be an important occupational risk among laboratory personnel. However, hepatitis A is a documented hazard in animal handlers and others working with naturally or experimentally infected chimpanzees and other non-human primates.³⁴ Workers handling other susceptible primates (e.g., owl monkeys, marmosets) also may be at risk for hepatitis A infection. Hepatitis E virus appears to be less of a risk to laboratory personnel than hepatitis A virus, except during pregnancy, when infection with HEV genotype 1 can result in increased maternal and fetal morbidity or mortality. Exposure to HEV-infected pigs, the primary animal reservoir for hepatitis E virus, rabbits, or macaques may pose an occupational hazard to animal handlers, but the extent of this risk is unknown.

Natural Modes of Infection

Most infections with hepatitis A are foodborne and occasionally waterborne. The virus has, on rare occasions, been transmitted through blood, blood-derived products, and other potentially infectious materials. Usually, infectious virus is

present in feces and blood during the incubation period, prodromal phase of the disease, and one week after jaundice onset, but it is not transmitted later in infection and the convalescence period. Hepatitis E virus genotypes 1 and 2 are transmitted via the fecal-oral route primarily by contaminated water in developing countries resulting in sporadic cases and occasionally large outbreaks. Hepatitis E virus genotypes 3 and 4 are associated with zoonotic hepatitis E infections transmitted to humans mainly through consumption of raw or undercooked pork and game meat or by contact with infected animals. This occurs in developed countries and results in sporadic cases. Transmission through blood and blood-derived products has been reported. Infection generally causes an acute self-limiting disease after an incubation period of two to six weeks but chronic infection with genotype 3 has been reported in immunocompromised individuals.

Laboratory Safety and Containment Recommendations

These agents may be present in feces and blood of infected humans and non-human primates. Feces, stool suspensions, and other contaminated materials are the primary hazards to laboratory personnel. Care should be taken to avoid puncture wounds when handling contaminated blood from humans or non-human primates. There is no evidence that aerosol exposure results in infection. Although hepatitis A virus is known to be one of the most stable viruses in the environment, hepatitis E virus is also very stable.

BSL-2 practices, containment equipment, and facilities are recommended for the manipulation of hepatitis A and E viruses, infected feces, blood, or other tissues. ABSL-2 practices and facilities are recommended for activities using naturally or experimentally-infected non-human primates or other animal models that may shed the virus.

Special Issues

Vaccines FDA-licensed inactivated vaccines against hepatitis A are available. There are no FDA-licensed vaccines against hepatitis E in the U.S., but a vaccine is currently available in China.

Transfer of Agent Importation of this agent requires CDC and/or USDA importation permits. Domestic transport of this agent may require a permit from USDA APHIS VS. A DoC permit may be required for the export of this agent to another country. See [Appendix C](#) for additional information.

Hepatitis B Virus, Hepatitis C Virus, Hepatitis D Virus

Hepatitis B virus (HBV) is the type species of the *Orthohepadnavirus* genus in the family *Hepadnaviridae*. Hepatitis C virus (HCV), with six genotypes, is the type species of the *Hepacivirus* genus in the family *Flaviviridae*. Hepatitis D virus (HDV) is the only member of the genus *Deltavirus*.

Occupational Infections

Hepatitis B has been one of the most frequently occurring Laboratory-associated infections, and laboratory workers are recognized as a high-risk group for acquiring such infections.^{35,36,38}

Hepatitis C virus infection can occur in the laboratory as well.³⁷ The prevalence of the antibody to hepatitis C (anti-HCV) is slightly higher in medical care workers than in the general population. Epidemiologic evidence indicates that HCV is spread predominantly by the parenteral route.³⁹

Natural Modes of Infection

These viruses are naturally acquired from a carrier during blood transfusion, injection, tattooing, or body piercing with inadequately sterilized instruments. Non-parenteral routes, such as domestic contact and unprotected (heterosexual and homosexual) intercourse, are potential modes of transmission. Vertical transmission (i.e., mother to child) is also possible.

Individuals who are infected with the HBV are at risk of infection with HDV, a defective RNA virus that requires the presence of HBV for replication. Infection with HDV usually exacerbates the symptoms caused by HBV infection.

Laboratory Safety and Containment Recommendations

HBV may be present in blood and blood products of human origin, in urine, semen, CSF, and saliva. Parenteral inoculation, droplet exposure of mucous membranes, and contact exposure of broken skin are the primary laboratory hazards.⁴⁰ The virus may be stable in dried blood or blood components for several days. Attenuated or avirulent strains have not been identified.

HCV has been detected primarily in blood and serum, less frequently in saliva, and rarely or not at all in urine or semen. It appears to be somewhat stable at room temperature on surfaces or equipment.^{41,42} Infectivity of the virus is sensitive to repeated freezing and thawing.

BSL-2 facilities with additional primary containment and personnel precautions, such as those described for BSL-3, may be indicated for activities with potential for droplet or aerosol production and for activities involving production quantities or concentrations of infectious materials. BSL-2 practices, containment equipment, and facilities are recommended for all activities utilizing known or potentially infectious body fluids and tissues. ABSL-2 practices, containment equipment, and facilities are recommended for activities utilizing naturally or experimentally infected chimpanzees or other non-human primates (NHPs). Gloves should be worn when working with infected animals and when there is the likelihood of skin contact with infectious materials. In addition to these

recommended precautions, persons working with HBV, HCV, or other bloodborne pathogens should consult the OSHA Bloodborne Pathogen Standard.⁴³

Special Issues

Vaccines Licensed recombinant vaccines against hepatitis B are available and are highly recommended for laboratory personnel.^{35,36,38} Vaccines against hepatitis C and D are not yet available for use in humans, but vaccination against HBV will also prevent HDV infection.

Transfer of Agent Importation of this agent requires CDC and/or USDA importation permits. Domestic transport of this agent may require a permit from USDA APHIS VS. A DoC permit may be required for the export of this agent to another country. See [Appendix C](#) for additional information.

Macacine alphaherpesvirus 1 (Herpesvirus Simiae, Cercopithecine herpesvirus 1, Herpes B Virus)

B virus is a member of the *Alphaherpesvirus* genus (simplexvirus) in the family *Herpesviridae*. It occurs naturally in macaque monkeys, of which there are nine distinct species. Macaques may have primary, recurrent, and latent infections, often with no apparent symptoms or lesions. B virus is the only member of the family of simplex herpesviruses that can cause zoonotic infections. Human infections have been identified in at least 50 instances, with approximately 80% mortality when untreated.⁴⁴ There have been no reported fatal cases where prompt first aid with wound or exposure site cleansing was performed within minutes after the exposure and post-exposure prophylaxis was given. Reactivated ocular disease has occurred in one individual,⁴⁵ and three infections resulting in seroconversion to B virus have occurred in the last decade. Cases prior to 1970 were not treated with antiviral agents because none were available. Morbidity and mortality associated with zoonotic infection result from invasion of the central nervous system, resulting in ascending paralysis ultimately with loss of ability to sustain respiration in the absence of mechanical ventilation. From 1987–2016, five additional fatal infections brought the number of lethal infections to 21 since the discovery of B virus in 1932.⁴⁶

Occupational Infections

B virus is a hazard in facilities where macaque monkeys are present. Mucosal secretions (i.e., saliva, genital secretions, and conjunctival secretions) are the primary body fluids associated with the risk of B virus transmission. However, it is possible for other materials to become contaminated. For instance, in 1997 a research assistant at the Yerkes Primate Center suffered a mucosal splash without injury while transporting a caged macaque; the individual subsequently died.⁴⁷ Based on the work being performed, the activity was considered

low-risk at that time. However, feces, urine, or other fluids and surfaces may be contaminated with virus shed from mucosal fluids. Zoonoses have been reported following virus transmission through a bite, scratch, or splash accident, but in at least two cases, no recognized exposure could be recalled. In one such case, fatality occurred. Multiple cases of B virus have also been reported after exposure to monkey cell cultures and to central nervous system tissue. There is often no apparent evidence of B virus infection in the animals or their cells and tissues, making it imperative that all suspect exposures be treated according to recommended standards.⁴⁴ However, the risks associated with this hazard are readily reduced by practicing barrier precautions and by rapid and thorough cleansing immediately following possible site contamination. Precautions should be taken when work requires the use of any macaque species, even antibody-negative animals. Animals that are seronegative may be acutely infected and shedding virus but not yet antibody positive. In most documented cases of B virus zoonosis, the virus was not recovered from potential sources except in four cases, making speculations that some macaque species may be safer than others unfounded. The loss of five lives in the past three decades underscores that B virus infections have a low probability of occurrence, but when they do occur there are high consequences.

Specific, regular training for B virus hazards, including understanding the modes of exposure and transmission, should be provided to individuals encountering B virus hazards. Training should also include proper use of engineering controls and personal protective equipment, which is essential to prevention. Immediate and thorough cleansing following bites, scratches, splashes, or contact with potential fomites in high-risk areas appears to be helpful in prevention of B virus infections.⁴⁷ First aid and emergency medical assistance procedures are most effective when institutions set the standard to be practiced by all individuals encountering B virus hazards.

Natural Modes of Infection

B virus occurs as a natural infection of Asiatic macaque monkeys and approximately 10% of newly caught rhesus monkeys have antibodies against the virus, which is frequently present in kidney cell cultures of this animal. In macaque species, the virus can cause vesicular lesions on the tongue and lips and sometimes of the skin. B virus is not present in blood or serum in healthy infected macaques. Transmission of B virus appears to increase when macaques reach sexual maturity.

Laboratory Safety and Containment Recommendations

The National Academies Press published the Institute for Laboratory Animal Research's (ILAR) guidelines for working with non-human primates.⁴⁸ The guidelines provide additional information regarding risks and mitigation strategies when handling non-human primates.

Asymptomatic B virus shedding accounts for most transmission among monkeys and human workers, but those working in the laboratory with potentially infected cells or tissues from macaques are also at risk. Exposure via mucous membranes or skin breaks provides this agent access to a new host, whether the virus is being shed from a macaque or human, or is present in or on contaminated cells, tissues, or surfaces.⁴⁴ B virus is not generally found in serum or blood, but these products obtained through venipuncture should be handled carefully because contamination of needles via skin can occur. When working with macaques directly, the virus can be transmitted through bites, scratches, or splashes only when the animal is shedding virus from mucosal sites. Fomites or contaminated surfaces (e.g., cages, surgical equipment, tables) should always be considered sources of B virus unless verified as decontaminated or sterilized. Zoonotically infected humans should be cautioned about autoinoculation of other susceptible sites when shedding virus during acute infection.

BSL-4 facilities are recommended for the propagation of viruses obtained from diagnostic samples or stocks. Experimental infections of macaques as well as small animal models with B virus are recommended to be restricted to ABSL-4 containment. BSL-3 practices are recommended for handling diagnostic materials with possible B virus. BSL-2 practices and facilities are suitable for all activities involving the use or manipulation of tissues, cells, blood, or serum from macaques with appropriate personal protective equipment.

All macaques regardless of their origin should be considered potentially infected. Animals with no detectable antibody are not necessarily B virus-free. Macaques should be handled with strict barrier precaution protocols and injuries should be tended immediately according to the recommendations of the B Virus Working Group led by NIH and CDC.⁴⁴

Barrier precautions and appropriate first aid are the keys to prevention of severe morbidity and mortality often associated with B virus zoonoses. These prevention tools were not implemented in each of the five B virus fatalities during the past three decades. Guidelines are available for safely working with macaques and should be consulted.^{44,49} The correct use of gloves, masks, and protective coats, gowns, aprons, or overalls is recommended for all personnel while working with non-human primates, especially macaques and other Old World species; this is inclusive for all persons entering animal rooms where non-human primates are housed. To minimize the potential for mucous membrane exposure, some form of barrier is required to prevent droplet splashes to eyes, mouth, and nasal passages. Types and use of personal protective equipment (e.g., goggles or glasses with solid side shields and masks, or wrap-around face shields) should be determined with reference to the institutional risk assessment. Specifications of protective equipment must be balanced with the work to be performed so that

the barriers selected do not increase workplace risk by obscuring vision and contributing to increased risk of bites, needlesticks, scratches, or splashes.

Special Issues

Post-exposure prophylaxis with oral acyclovir or valacyclovir should be considered when exposures are thought to have occurred. Even a slight scratch can result in transmission. Therapy with intravenous acyclovir and/or ganciclovir in documented B virus infections is also important in the reduction of morbidity following B virus zoonotic infection.⁴⁴ Ganciclovir is generally reserved for symptomatic cases confirmed by CSF evaluation. Because of the seriousness of B virus infection, experienced medical and laboratory personnel should be consulted to develop individual case management. Barrier precautions should be observed with confirmed cases. B virus infection, as with all alphaherpesviruses, is lifelong in macaques.⁵⁰ There are no effective vaccines available and no curative therapeutics for humans.

Transfer of Agent Importation of this agent requires CDC and/or USDA importation permits. Domestic transport of this agent may require a permit from USDA APHIS VS. A DoC permit may be required for the export of this agent to another country. See [Appendix C](#) for additional information.

Human Herpes Virus

The herpesviruses are ubiquitous human pathogens and are commonly present in a variety of clinical materials submitted for virus isolation. Thus far, nine herpesviruses have been isolated from humans: herpes simplex virus-1 (HSV-1), herpes simplex virus-2 (HSV-2), human cytomegalovirus (HCMV), varicella-zoster virus (VZV), Epstein-Barr virus (EBV), and human herpesviruses (HHV) 6A, 6B, 7, and 8.⁵¹

Because these viruses establish lifelong latency in human tissues, they may manifest either as primary or recurrent infections. HSV primary and recurrent infections are usually characterized by localized vesicular lesions at or near the site of the initial infection. Primary infection with HSV-1 often occurs in early childhood and may be mild and unapparent. Symptoms such as fever or malaise can sometimes occur. HSV-1 is a frequent cause of viral meningoencephalitis. Genital infections, usually caused by HSV-2, generally occur in adults and are sexually transmissible.

Disseminated disease and encephalitis that may occur in neonatal infections can be fatal. EBV is the most frequent cause of infectious mononucleosis and is also associated with the pathogenesis of several lymphomas and nasopharyngeal cancer.^{52,53} EBV-associated cancers normally have viral genomes integrated into the transformed cells. HCMV is often undiagnosed, presenting as a nonspecific

febrile illness with features of infectious mononucleosis. HCMV can cause severe congenital syndrome, which may manifest as mental retardation, microcephaly, motor disabilities, and chronic liver disease in infants who were exposed to the virus in utero.⁵¹ Congenital HCMV is also a frequent cause of deafness in children who were exposed to the virus in utero.

Primary infection with VZV causes chickenpox, while recurrences of this viral infection cause herpes zoster (shingles). Primary infection with HHV-6B or HHV-7 can cause exanthem subitum (roseola), a common childhood rash-associated illness and can also be a cause of infectious mononucleosis syndrome.^{53,54} Other clinical manifestations of roseola include nonspecific febrile illness and febrile seizures. Reactivation of HHV-6 is usually identified only in the severely immunocompromised, when it may be associated with encephalitis or other manifestations. Disease caused by HHV-6A, which is a less common infection that usually occurs after early childhood, is less well-understood. HHV-8 is the causative agent of Kaposi's sarcoma and of primary effusion lymphoma.⁵⁵ High-risk groups for HHV-8 include HIV-infected men who have sex with men and individuals from areas of high endemicity, such as Africa or the Mediterranean.⁵⁶ The prevalence of HHV-8 is also higher among intravenous drug users than in the general population.⁵⁶ At least one report has provided evidence that, in African children, HHV-8 infection may be transmitted from mother to child.⁵⁷

While few of the human herpesviruses have been demonstrated to cause Laboratory-associated infections, they are both primary and opportunistic pathogens, especially in immunocompromised hosts, in whom recurrent infections can be particularly severe and even life-threatening. Macacine alphaherpesvirus 1 (B-virus, Monkey B virus) is not a human herpesvirus and is discussed separately in the preceding agent summary statement.

Occupational Infections

Few of the human herpesviruses have been documented as sources of Laboratory-associated infections. Although this diverse group of viral agents has not demonstrated a high potential hazard for Laboratory-associated infection, frequent presence in clinical materials and common use in research warrant the application of appropriate laboratory containment and safe practices.

Natural Modes of Infection

Given the wide array of viruses included in this family, the natural modes of infection vary greatly, as does the pathogenesis of the various viruses. These viruses both infect and establish latency in different types of cells leading to some of the major clinical differences in the disease that they cause. Transmission of human herpesviruses in nature is generally associated with close, intimate

contact with a person excreting the virus in their saliva, urine, or other bodily fluids.⁵⁷ For example, VZV is transmitted person-to-person through direct contact, aerosolized vesicular fluids, and respiratory secretions. HHV-8 and CMV can be transmitted through organ transplantation^{58,59} and blood transfusion.⁶⁰ The ability of HHV-6 to integrate into the human genome allows vertical transmission in a small percentage of cases.

Laboratory Safety and Containment Recommendations

Clinical materials, including blood, urine, and saliva, and isolates of human herpesviruses may pose a risk of infection following ingestion, parenteral inoculation, and droplet exposure of the mucous membranes of the eyes, nose, or mouth, exposure to non-intact skin, or inhalation of concentrated aerosolized materials. Clinical specimens containing the more virulent Macacine alphaherpesvirus 1 (B-virus) may be inadvertently submitted for diagnosis of suspected herpes simplex infection, though the combination of a suspected herpes simplex infection with exposure to a rhesus macaque should trigger serious concern in the treating physician, and ideally would involve special labelling and consultation with the microbiology laboratory. HCMV may pose a special risk to pregnant women because of potential infection of the fetus. All human herpesviruses pose an increased risk to persons who are immunocompromised and are not previously immune to these viruses.

BSL-2 facilities with additional containment and procedures, such as those described for BSL-3, should be considered when producing, purifying, and concentrating human herpesviruses, based on risk assessment. BSL-2 practices, containment equipment, and facilities are recommended for activities utilizing known or potentially infectious clinical materials or cultures of indigenous viral agents that are associated or identified as a primary pathogen of human disease. Although there is little evidence that infectious aerosols are a significant source of LAIs, it is prudent to avoid the generation of aerosols during the handling of clinical materials or isolates or during the necropsy of animals.

Autologous transformation of B cells using EBV should not be performed.

Containment recommendations for Macacine alphaherpesvirus 1 (B-virus, Monkey B virus) are described in the preceding agent summary statement.

Special Issues

Vaccines Vaccines for varicella-zoster are licensed and available in the United States. In the event of a laboratory exposure to a non-immune individual, varicella vaccine is likely to prevent or at least reduce the severity of disease.⁶¹

Treatment Antiviral medications are available for treatment or prevention of infections with several of the human herpesviruses.

Transfer of Agent Importation of this agent requires CDC and/or USDA importation permits. Domestic transport of this agent may require a permit from USDA APHIS VS. A DoC permit may be required for the export of this agent to another country. See [Appendix C](#) for additional information.

Influenza Viruses

Influenza is an acute viral disease of the respiratory tract. The most common clinical manifestations are fever, headache, malaise, sore throat, cough, and muscle aches. GI tract manifestations (e.g., nausea, vomiting, diarrhea) are rare but may accompany the respiratory phase in children. The two most important features of influenza are the epidemic nature of illness and the mortality that arises from pulmonary complications of the disease.⁶²

Influenza virus infection may be associated with extrapulmonary complications, including viral myocarditis and viral encephalitis. Cardiovascular deaths during influenza epidemics have increased indicating that cardiovascular complications, including exacerbation of chronic underlying conditions, are important contributors to influenza-related morbidity and mortality.^{63,64}

Influenza viruses are enveloped RNA viruses belonging to the family *Orthomyxoviridae*. There are four serotypes of influenza viruses—A, B, C, and D, of which human infections have been virologically confirmed for all except influenza D viruses. Influenza A viruses are further classified into subtypes by the surface glycoproteins hemagglutinin (H) and neuraminidase (N). Emergence of new subtypes (antigenic shift) in humans occurs at irregular intervals with Type A viruses. New subtypes can result from reassortment of human, swine, and avian influenza A virus genes. If there is little or no population immunity and the viruses are able to spread in a sustained manner from human-to-human, they can be responsible for rare pandemics. Minor antigenic changes within a circulating seasonal influenza A virus subtype or influenza B virus lineage (antigenic drift) are ongoing processes that are responsible for annual epidemics that make the annual reformulation of influenza vaccines necessary.

Influenza A viruses of different antigenic subtypes occur naturally in many domestic and wild avian species and have formed sustained lineages in swine, equine, and canine species. Avian origin influenza A viruses also sporadically infect multiple other mammalian species. Two influenza A virus subtypes have only been detected in bats. Novel influenza A virus infections of humans (zoonotic transmission of avian or variant [swine-origin] influenza A viruses) occur sporadically.⁶⁵ Limited, non-sustained human-to-human transmission of some novel influenza A viruses has been reported following prolonged unprotected exposures to an ill index case.^{66–68} Interspecies transmission and reassortment of influenza A viruses have been reported to occur among humans, pigs, and wild and domestic fowl. The influenza A viruses responsible for the 1918, 1957, 1968, and 2009

pandemics contained gene segments closely related to those of avian or swine influenza A viruses.^{69–71} Control of influenza is a continuing human and veterinary public health concern.

Occupational Infections

LAI, in the absence of animals, have not been well documented in the literature. However, it is believed that there is a risk of possible exposure to infectious influenza virus in the laboratory, especially through work with high concentrations of virus and/or experimental operations that generate aerosols (e.g., centrifugation, vortex-mixing). Animal-associated infections in the laboratory or the field have been reported.^{72–74} LAIs may result from inoculation of mucous membranes including the upper respiratory tract through fomite transmission (e.g., touching virus-contaminated gloves to one's face following handling of tissues, feces, or secretions from infected animals; touching contaminated door handles or computer keyboards and then touching mucous membranes).

Natural Modes of Infection

Near-range inhalation through droplet/airborne spread is the predominant mode of influenza virus transmission among humans. Transmission may also theoretically occur through direct contact of contaminated surfaces and subsequent inoculation of mucous membranes including the upper respiratory tract since influenza viruses may persist for hours on surfaces particularly in the cold and under conditions of low humidity.⁶⁹ The incubation period is from one to four days. Recommendations for antiviral treatment and chemoprophylaxis of influenza are available.⁷⁵

Laboratory Safety and Containment Recommendations

The agent may be present in respiratory tissues or secretions of humans and infected animals and birds. In addition, the agent may be present in the intestines and cloacae of many infected avian species. Influenza viruses may be disseminated in multiple organs in some infected animal species. The primary laboratory hazard is inhalation of the virus from aerosols generated by infecting animals or by aspirating, dispensing, mixing, centrifuging, or otherwise manipulating virus-infected materials. Genetic manipulation has the potential for altering the host range, pathogenicity, and antigenic composition of influenza viruses. The potential for introducing influenza viruses with novel genetic composition into humans is unknown.

Seasonal Human Influenza Viruses BSL-2 facilities, practices, and procedures are recommended for diagnostic research and production activities utilizing contemporary influenza A, B, and C viruses circulating among humans (e.g., H1/H3/B). ABSL-2 is appropriate for work with these viruses in animal models.

Zoonotic and Animal Influenza A Viruses BSL-3 or ABSL-3 containment, with enhancements directed by regulatory authorities, should be used for laboratory work with low pathogenicity avian influenza (LPAI) A viruses that have caused zoonotic infections, particularly those with fatal outcomes (e.g., H7N4, H10N8). Work with Asian lineage A(H7N9) and non-U.S. LPAI A viruses should also be conducted in BSL-3 or ABSL-3 laboratories with practices, procedures, and facilities enhancements, as directed by regulatory authorities.

BSL-2 with enhanced facilities, practices, and procedures, as directed by regulatory authorities, should be used for working with domestic LPAI A viruses (e.g., H1–4, H6, H8–16) and equine, canine, and swine influenza A viruses. ABSL-2 with enhancements directed by regulatory authorities is appropriate for work with these viruses in animal models. Asian lineage A(H7N9) LPAI viruses have caused sporadic zoonotic infections with high mortality in humans since 2013.⁷⁶

Non-Contemporary Human Influenza Viruses Non-contemporary, wild-type human influenza A(H2N2) viruses or reassortants containing the H2 or N2 RNA segments should be handled with increased caution. Important considerations in working with these viruses are the number of years since an antigenically related virus last circulated and the potential presence of a susceptible population. BSL-3 and ABSL-3 practices, procedures, and facilities are recommended with rigorous adherence to respiratory protection and clothing change protocols. Negative pressure, HEPA-filtered respirators and eye protection, or positive air-purifying respirators (PAPRs) are recommended for use. Cold-adapted, live attenuated A(H2N2) vaccine viruses may be worked with at BSL-2, but it is recommended that a risk assessment be performed before working with such viruses, and attention should be paid to prevent generation of reassortants that have H2 and/or N2 RNA segments and lack attenuating features of the parental attenuated viruses.

Historical, wild-type human influenza A(H1N1) and A(H3N2) viruses that have not circulated among humans in many years should be handled with increased precaution since younger adult workers and children have little or no immunity against such viruses. It is recommended that a risk assessment be performed before working with such viruses; this would include consideration of the number of years since a closely related virus last circulated among humans. For example, pre-2009 A(H1N1) viruses have not circulated in humans since the 2009–2010 season and there is little antigenic similarity between these viruses and the A(H1N1)pdm09 viruses that were responsible for the 2009 influenza pandemic. Other examples may arise in the future. In such cases, a more cautious approach to containment utilizing elevated Biosafety Levels and practices is warranted (e.g., BSL-2 with enhanced practices, procedures, and facilities).

1918 Influenza A(H1N1) Pandemic Virus Any research involving reverse genetics of the 1918 influenza A(H1N1) pandemic virus should proceed with extreme caution. Research findings suggest that exposure to A(H1N1)pdm09 virus through immunization or infection would provide protection against the reconstructed 1918 A(H1N1) virus.⁷⁷ Moreover, several serological studies of the A(H1N1)pdm09 virus have provided evidence for the presence of preexisting, cross-reactive antibodies to a 1918-like H1N1 virus from previous vaccinations or infections.^{78,79} However, the 1918 A(H1N1) virus is still considered to pose both biosafety and biosecurity threats. The following practices and conditions are recommended for manipulation of reconstructed 1918 influenza A(H1N1) viruses and laboratory animals infected with the viruses. These following practices and procedures are considered minimum standards for work with the fully reconstructed virus.

- BSL-3 and ABSL-3 practices, procedures, and facilities;
- Animals, including non-human primates (NHPs), should be housed in primary barrier systems in ABSL-3 facilities;
- Use of negative pressure, HEPA-filtered respirators, or PAPRs;
- Rigorous adherence to respiratory protection and clothing change protocols;
- HEPA filtration for treatment of exhaust air; and
- Personal showers prior to exiting the laboratory.

Highly Pathogenic Avian Influenza (HPAI) A Viruses Manipulating HPAI A viruses (e.g., H5, H7) in biomedical research laboratories also requires additional precautions because some viruses may pose increased risk to laboratory workers and have significant agricultural and economic implications. BSL-3 and ABSL-3 with enhanced practices, procedures, and facilities, as directed by regulatory authorities, are required, including clothing change and personal showering protocols. Loose-housed animals infected with HPAI A viruses must be contained within ABSL-3Ag facilities. See [Appendix D](#) for additional information. Negative pressure, HEPA-filtered respirators and eye protection, or positive air-purifying respirators are recommended for HPAI A viruses with potential to infect humans.

Other Influenza Recombinant or Reassortant Viruses When considering the biocontainment level and attendant practices and procedures for work with other influenza recombinant or reassortant viruses, the IBC, or equivalent resource, should consider but not limit consideration to the following in the conduct of protocol-driven risk assessment.

- The gene constellation used;
- Any mutations that are introduced and may result in enhancement of a pathogen's transmissibility and/or virulence;⁸⁰
- Clear evidence of reduced virus replication in the respiratory tract of appropriate animal models, compared with the level of replication of the wild-type parent virus from which it was derived;

- Evidence of clonal purity and phenotypic stability; and
- The number of years since a virus that was antigenically related to the donor of the hemagglutinin and neuraminidase genes last circulated.

If adequate risk assessment data are not available, a more cautious approach to containment, utilizing elevated Biosafety Levels and practices, is warranted.

Special Issues

Occupational Health Considerations Institutions performing work with HPAI and LPAI A viruses that have infected humans; non-contemporary wild-type human influenza A viruses, including recombinants and reassortants; and viruses created by reverse genetics of extinct virus strains (e.g., 1918 strain) should develop and implement a specific medical surveillance and response plan. At a minimum, these plans should: 1) strongly recommend annual vaccination with a currently licensed influenza vaccine for such individuals; 2) provide employee counseling regarding disease signs and symptoms including fever, conjunctivitis, and respiratory symptoms; 3) establish a protocol for monitoring personnel for these symptoms; 4) include collection of acute and convalescent serum samples in the event of a possible LAI; and 5) establish a clear medical protocol for responding to suspected Laboratory-associated infections. Antiviral drugs (e.g., oseltamivir, zanamivir) should be available for treatment of illness or post-exposure treatment/chemoprophylaxis, as necessary.⁷⁵ It is recommended that the virus under study be tested for susceptibility to antiviral drugs. All personnel should be enrolled in an appropriately constituted respiratory protection program.

Select Agent The reconstructed 1918 influenza A(H1N1) virus and HPAI viruses are Select Agents requiring registration with CDC or USDA for possession, use, storage, and/or transfer. See [Appendix F](#) for additional information.

Transfer of Agent Importation and transfer of animal-origin viruses and diagnostic specimens obtained from animals require APHIS importation permits. CDC/PHS import permits are required for importation of seasonal influenza A, B, and C viruses and specimens obtained from humans. CDC/PHS permits may also be required for importation of animal-origin influenza viruses of known zoonotic potential. Importation and transfer of Select Agent viruses require APHIS/CDC importation permits. APHIS permit-driven containment, facility requirements, and personnel practices and/or restrictions may be applied for the possession and handling of animal-origin and zoonotic viruses. This may also include laboratory data/results to exclude the possibility of contamination with HPAI Select Agent viruses in specimens. A DoC export license or license exemption may be required for the export of Select Agent viruses to another country. See [Appendix C](#) for additional information.

Lymphocytic Choriomeningitis Virus

Lymphocytic choriomeningitis (LCM) is a rodent-borne viral infectious disease that presents as aseptic meningitis, encephalitis, or meningoencephalitis. The causative agent is the LCM virus (LCMV) that was initially isolated in 1933. The virus is the prototypical member of the family *Arenaviridae*.

Occupational Infections

LAI with LCM virus are well documented. Most infections occur when chronic viral infection exists in laboratory or pet rodents, especially mice, hamsters, and guinea pigs.^{81–83} Nude and severe combined immune deficient (SCID) mice may pose a special risk of harboring silent chronic infections. Mice shedding the virus may be asymptomatic. Inadvertently infected cell cultures also present a potential source of infection and dissemination of the agent.

Natural Modes of Infection

LCMV infections have been reported in Europe, the Americas, Australia, and Japan, and may occur wherever infected rodent hosts are found. Several serologic studies conducted in urban areas have shown that the prevalence of LCMV infection among humans ranges from 2% to 10%. Seroprevalence of 37.5% has been reported in humans in the Slovak Republic.⁸⁴

The common house mouse, *Mus musculus*, naturally spreads LCMV. Once infected, these mice can become chronically infected as demonstrated by the presence of virus in blood and/or by persistently shedding virus in urine. Infections by *Callitrichid* hepatitis virus, a strain of LCMV, have also occurred in NHPs in zoos, including macaques and marmosets.

Humans become infected by inhaling infectious aerosolized particles of rodent urine, feces, or saliva; by ingesting food contaminated with the virus; by contamination of mucous membranes with infected body fluids; or by directly exposing cuts or other open wounds to virus-infected blood. Several clusters of organ recipients from donors with unrecognized acute LCMV infection have been described with poor survival rates in the immunosuppressed recipients.^{85–89} The source of donors' infection is usually untraceable except in one case where a pet hamster that was not overtly ill was incriminated.⁸⁹ Pregnant women infected with LCMV have transmitted the virus to their fetuses that resulted in death or serious central nervous system malformation as a consequence.⁹⁰

Laboratory Safety and Containment Recommendations

The agent may be present in blood, CSF, urine, secretions of the nasopharynx, feces, and tissues of infected animal hosts and humans. Parenteral inoculation, inhalation, contamination of mucous membranes or broken skin with infectious tissues or fluids from infected animals are common hazards. Aerosol transmission is well documented.⁸¹

Of special note, tumors may acquire LCMV as an adventitious virus without obvious effects on the tumor. The virus may survive freezing and storage in liquid nitrogen for long periods. When infected tumor cells are transplanted, subsequent infection of the host and virus excretion may occur.

Women of childbearing age should be made aware of risks posed by LCMV or rodents potentially infected by LCMV. Women who are pregnant or planning to become pregnant should be provided medical counseling that informs them of these risks with LCMV or animals potentially infected with LCMV.

Strains of LCMV that are shown to be lethal in non-human primates should be handled at BSL-3. BSL-3 is also required for activities with high potential for aerosol production, work with production quantities or high concentrations of infectious materials, and for manipulation of infected transplantable tumors, field isolates, and clinical materials from human cases. Work with infected hamsters should be done at ABSL-3.

BSL-2 practices, containment equipment, and facilities are suitable for activities utilizing known or potentially infectious body fluids and for cell culture passage of laboratory-adapted strains. ABSL-2 practices, containment equipment, and facilities are suitable for studies in adult mice with mouse brain-passaged strains requiring BSL-2 containment.

Special Issues

Vaccines Vaccines are not available for use in humans.

Transfer of Agent Importation of this agent requires CDC and/or USDA importation permits. Domestic transport of this agent may require a permit from USDA APHIS VS. A DoC permit may be required for the export of this agent to another country. See [Appendix C](#) for additional information.

Poliovirus

Poliovirus is the type species of the *Enterovirus* genus in the family *Picornaviridae*. Picornaviruses are small viruses with an RNA genome. Enteroviruses are likely transient inhabitants of the gastrointestinal tract and are stable at acid pH. There are three poliovirus serotypes: PV1, PV2, and PV3. Immunity to one serotype does not produce significant immunity to the other two.

Occupational Infections

Laboratory-associated poliomyelitis is uncommon. Twelve cases, including two deaths, were reported between 1941 and 1976.^{91,92} Several instances of asymptomatic laboratory infections with poliovirus have been reported, but no laboratory-associated poliomyelitis has been reported for over 40 years. Both inactivated poliovirus vaccine (IPV) and oral poliovirus vaccine (OPV) are

highly effective in preventing disease. OPV alone induces mucosal immunity, which gradually fades over subsequent years. Poliovirus infections among immunized laboratory workers remain undetermined in the absence of laboratory confirmation. An immunized laboratory worker may unknowingly be a source of poliovirus transmission to susceptible persons in the community.⁹³ In April 2017, a spill of WPV2 in a production facility in the Netherlands infected one operator whose stool tested positive for poliovirus. This incident highlights the risk of containment breach and emphasizes the need for appropriate incident response planning and government oversight.⁹⁴

Natural Modes of Infection

Humans are the only known reservoir of poliovirus, which is transmitted most frequently by persons with inapparent infections. Person-to-person spread of poliovirus via the fecal-oral route is the most common route of transmission, although the oral-oral route may account for some cases. Only one in several hundred infections of unimmunized persons with wild poliovirus leads to paralytic disease, with the vast majority of infections being asymptomatic or accompanied by minor, flu-like symptoms.

At one time, poliovirus infection occurred throughout the world. Transmission of wild poliovirus ceased in the United States by 1979. A polio eradication program conducted by the Pan American Health Organization led to elimination of polio from the Western Hemisphere in 1991. The Global Polio Eradication Program, led by the World Health Organization, has dramatically reduced the number of paralytic cases.

The last case of wild PV2 (WPV2) was detected in 1999, and certification of WPV2 eradication occurred in 2015. Since WPV2 was eradicated, all polio cases associated with PV2 have been caused by oral polio vaccine (OPV) directly (vaccine-associated paralytic polio [VAPP]) or by vaccine-derived polio type 2 virus (VDPV2). Due to continued occurrence of VAPP and outbreaks and chronic infections associated with VDPV2, WHO discontinued all routine OPV2 use as of May 1, 2016 by coordinating a global switch from trivalent OPV to bivalent OPV, containing only OPV1 and 3, along with the introduction of a single dose of inactivated polio vaccine (IPV). The last case of WPV3 occurred in Nigeria in 2012 and certification of WPV3 eradication occurred in 2019. As of 2019, only three countries (Pakistan, Afghanistan, and Nigeria) are considered to be endemic for WPV1. Complete polio eradication is expected in the near future.

Laboratory Safety and Containment Recommendations

Poliovirus is present in stool and in throat secretions of infected persons and in lymph nodes, brain tissue, and spinal cord tissue in fatal cases. In addition, poliovirus may be present in environmental samples (e.g., sewage).

Ingestion and parenteral inoculation are the primary routes of infection for laboratory workers. For immunized persons parenteral inoculation likely presents a lower risk. The potential for aerosol exposure is unknown. Laboratory animal-associated infections have not been reported, but infected non-human primates should be considered to present a risk.

Laboratory personnel working with and visitors with access to known poliovirus or infectious materials potentially containing poliovirus must have documented polio vaccination. Persons who have had a primary series of OPV or IPV and who are at an increased occupational risk should receive another dose of IPV. Available data do not indicate the need for more than a single lifetime IPV booster dose for adults.⁹⁵

Type 2 and WPV3 Declaration of WPV2 eradication and the termination of routine OPV2 use initiated the containment of PV2 under the WHO Global Action Plan III (GAPIII).⁹⁶ GAPIII seeks to decrease the risk of reintroduction of eradicated polioviruses from laboratories and other facilities by calling for the destruction of non-essential poliovirus materials and containment of retained poliovirus material in certified poliovirus-essential facilities that adhere to the containment measures specified in GAP III. These measures include a biorisk management system, biosafety, security, and physical laboratory features and, at the time of this writing, apply to WPV2 and VDPV types 2 and 3, VDPV2, and OPV2 infectious materials as well as WPV and VDPV potentially infectious materials (e.g., fecal, respiratory secretion, and environmental samples collected at a time and in a place where WPV or VDPV was present). The U.S. National Authority for Containment (NAC) of Poliovirus at the CDC is responsible for working with poliovirus facilities to achieve certification. At the time of final eradication of all poliovirus types, additional GAPIII physical laboratory containment measures will be required for WPV and VDPV materials.

OPV2 potentially infectious materials are subject to the Guidance for non-poliovirus facilities to minimize risk of sample collections potentially infectious for polioviruses.^{97,98} This document assigns risk categories based on the material and work performed and outlines specific risk mitigation measures that are much less stringent than GAPIII.

Type 1 and OPV3 When final eradication is declared, GAPIII containment will also apply to types 1 and OPV3. Laboratories and other facilities are encouraged to destroy all PV1 and OPV3 materials not essential for research or other work.

BSL-2 and ABSL-2 practices, containment equipment, and facilities are recommended for all activities using poliovirus infectious and potentially infectious materials, including environmental and clinical samples. Contact the U.S. NAC for enhanced measures for work with eradicated poliovirus types and strains.

Laboratories should work with attenuated Sabin OPV strains unless there are strong scientific reasons for working with wild polioviruses. Contact the NAC for additional measures for work with WPV and VDPV types 2 and 3, and OPV2 infectious materials.

Special Issues

Transfer of Agent Importation of this agent requires CDC and/or USDA importation permits. Domestic transport of this agent may require a permit from USDA APHIS VS. A DoC permit may be required for the export of this agent to another country. See [Appendix C](#) for additional information. Contact the NAC prior to transfers of polioviruses.

Poxviruses

Four genera within the *Chordopoxvirinae* subfamily (family *Poxviridae*) contain species that can cause human disease: *Orthopoxvirus*, *Parapoxvirus*, *Yatapoxvirus*, and *Molluscipoxvirus*.⁹⁹ Most species in these genera are zoonotic with the exception of variola virus (*Orthopoxvirus*) and molluscum contagiosum virus (*Molluscipoxvirus*), which are solely human pathogens.^{100,101} As most Laboratory-associated infections involve accidents associated with orthopoxviruses, only species of this genus will be discussed further.

Occupational Infections

Vaccinia virus is the prototypical orthopoxvirus, and its well-studied characteristics make it commonly used in both general and biomedical research.¹⁰² Thus, vaccinia virus is the leading agent of laboratory-associated poxvirus infections. LAIs with replication-competent species, including wild-type and modified strains of vaccinia virus, have occurred even in previously vaccinated laboratorians. Other persons at risk for occupational exposure include animal care personnel having direct contact with vaccinated or infected animals or their secretions, or healthcare personnel who care for vaccinated or infected patients or administer a live vaccinia virus.^{102,103}

The manifestation of infection is dependent upon factors such as virus species, route of entry, and host immune status. Infection results in the development of one to several lesions (localized) or a generalized rash (systemic) on the skin and/or mucous membranes. Infection with variola or monkeypox virus causes a febrile prodrome that is preceded by a distinct systemic rash illness. Vaccinia virus and cowpox virus typically cause a single lesion at the site of infection; however, multiple lesions and a generalized rash may also take place. Uncomplicated disease typically resolves within several weeks.^{99,100}

Natural Modes of Infection

The most well-known orthopoxvirus is variola virus, which causes smallpox. After an extensive vaccination campaign, smallpox was declared eradicated in 1980. Monkeypox occurs sporadically in several West and Central African countries but remains endemic in the Democratic Republic of Congo. The importation of wild-caught animals from Ghana into the United States resulted in a 2003 monkeypox outbreak that affected multiple states. Vaccinia virus is used to make the current smallpox vaccine. Naturally-acquired infections with vaccinia virus exist outside of the United States.¹⁰⁴ Cases of human cowpox occur in Europe and Asia. Rodents are known or suspected to play a part in the transmission of monkeypox, cowpox, and vaccinia viruses.^{99–101}

Laboratory Safety and Containment Recommendations

Vaccination with vaccinia virus can afford protection against infection from other species of orthopoxviruses. Smallpox vaccination occurs via scarification using a multi-puncture method with a bifurcated needle. The current U.S.-licensed smallpox vaccine, ACAM2000, uses a replication-competent vaccinia virus strain. Symptoms such as fever, headache, and swollen lymph nodes are prevalent following vaccination. Adverse events include localized reactions (e.g., robust take), unintentional transfer of virus (e.g., self-inoculation, ocular vaccinia), diffuse dermatologic complications (e.g., eczema vaccinatum, non-specific post-vaccination rash), progressive vaccinia, cardiac complications, fetal vaccinia, and postvaccinial central nervous system disease. Due to the severity of complications that can arise from vaccination, the vaccine is not recommended for persons with certain contraindications.^{99,103,105,106}

Orthopoxviruses are stable in a wide range of environmental temperatures and humidity. Virus may enter the body through the mucous membranes (e.g., eye splashes, inhalation of droplets or fine-particle aerosols), broken skin (e.g., needlesticks, scalpel cut), ingestion, or by parenteral inoculation. Sources of exposure include fomites, infected human or animal tissue, excretions or respiratory secretions, or infectious cultures.¹⁰⁶

Routine vaccination with ACAM2000 is recommended for laboratory personnel who directly handle cultures or animals contaminated or infected with replication-competent vaccinia virus, recombinant vaccinia viruses derived from replication-competent vaccinia strains (i.e., those that are capable of causing clinical infection and producing infectious virus in humans), or other orthopoxviruses that infect humans (e.g., monkeypox, cowpox, and variola).¹⁰⁶ Vaccination is advised every three years for work with monkeypox and variola viruses, and every 10 years for cowpox and vaccinia viruses. Vaccination is not required for individuals working in laboratories that only manipulate replication-deficient strains of vaccinia virus (modified virus Ankara [MVA], NYVAC, TROVAC,

and ALVAC). Vaccination may be offered to healthcare workers, animal care personnel, and vaccinators who have contact with contaminated materials. Vaccination does not protect against non-Orthopoxvirus species.^{103,106}

Research with variola virus is restricted to two WHO-approved BSL-4 and ABSL-4 facilities; one is the CDC in Atlanta, GA, and the other is the State Research Center of Virology and Biotechnology (VECTOR) in Koltsovo, Russia. ABSL-3 practices, containment equipment, and facilities are recommended for monkeypox work in experimentally or naturally infected animals. BSL-2 facilities with BSL-3 practices are advised if vaccinated personnel perform laboratory work with monkeypox virus. BSL-2 and ABSL-2 containment plus vaccination are recommended for work with vaccinia and other human pathogenic poxviruses. The lowering of containment to BSL-1 for the manipulation of attenuated poxviruses and vectors (e.g., modified virus Ankara [MVA], NYVAC, TROVAC, and ALVAC) in areas where no other human orthopoxviruses are being used may be considered. However, higher levels of containment are recommended if these strains are used in work areas where other orthopoxviruses are manipulated. Vaccination is not required for individuals working only in laboratories where no other orthopoxviruses or recombinants are handled. BSL-2 and ABSL-2 plus vaccination are recommended for work with most other poxviruses. Note that for research subject to the *NIH Guidelines*, approval to lower containment from BSL-2 must be requested from NIH Office of Science Policy.¹⁰⁷

Special Issues

The CDC provides information on a variety of topics relating to variola, monkeypox, and vaccinia viruses online at <https://www.cdc.gov>. For non-emergency information on potential human infections, smallpox vaccination, or treatment options, the CDC Poxvirus Inquiry Line can be contacted at 404-639-4129 or CDC-Info can be reached at 800-232-4636. To obtain smallpox vaccine, CDC Drug Services can be reached by phone at 404-639-3670 or by email at drugservice@cdc.gov. Clinicians or health departments may contact the CDC Emergency Operations Center in critical circumstances.

Select Agent Congo Basin monkeypox, Variola major, and Variola minor are Select Agents requiring registration with CDC for possession, use, storage, and/or transfer. See [Appendix F](#) for additional information.

Transfer of Agent The importation of poxviruses into the United States and/or their interstate transport may be subject to the rules and regulations of the CDC Import Permit Program, CDC Division of Select Agents and Toxins, and/or the USDA Animal and Plant Health Inspection Service. The exportation of poxviruses may require a DoC permit.

Rabies Virus and related lyssaviruses

Rabies is an acute, progressive, fatal encephalitis caused by negative-stranded RNA viruses in the genus *Lyssavirus*, family *Rhabdoviridae*.^{108,109} *Rabies lyssavirus* (formerly Rabies virus) is the representative member (type species) of the genus and is responsible for the majority of human and animal cases of rabies worldwide. Currently, there are 14 recognized viral species within the genus *Lyssavirus*, which can be found in Table 1.

Occupational Infections

Rabies LAIs are extremely rare; two cases have been documented. Both cases resulted from presumed exposure to high concentrations of infectious aerosols—one generated in a vaccine production facility¹¹⁰ and the other in a research facility.¹¹¹ Naturally or experimentally-infected animals, their tissues, and their excretions are also a potential source of exposure for laboratory and animal care personnel.

Natural Modes of Infection

The natural hosts of rabies virus are many bat species and terrestrial carnivores, but any mammal can be infected. The saliva of infected animals is highly infectious, and bites are the usual means of transmission, although infection through superficial skin lesions or mucosa is possible.

Laboratory Safety and Containment Recommendations

When working with infected animals, the highest viral concentrations are present in central nervous system (CNS) tissue, salivary glands, saliva, and lacrimal secretions, but rabies viral antigens may be detected in all innervated tissues. The most likely sources for exposure of laboratory and animal care personnel are accidental parenteral inoculation, cuts, or needlesticks with contaminated laboratory equipment, bites by infected animals, and exposure of mucous membranes or broken skin to infectious tissue or fluids. Infectious aerosols have not been a demonstrated hazard to personnel working with routine clinical materials or conducting diagnostic examinations. Fixed and attenuated strains of virus are presumed to be less hazardous, but the two recorded cases of laboratory-associated rabies resulted from presumed exposure to the fixed Challenge Virus Standard and Street Alabama Dufferin strains, respectively.^{110,111}

Additional precautions (such as BSL-2 with BSL-3 practices) should be considered when working with lyssaviruses other than rabies virus; refer to Table 1. BSL-2 and/or ABSL-2 practices, containment equipment, and facilities are recommended for all activities utilizing known or potentially infectious materials or animals. Pre-exposure rabies vaccination is recommended for all individuals prior to working with lyssaviruses or infected animals or engaging in diagnostic, production, or research activities with these viruses.¹¹² Rabies

vaccination is also recommended for all individuals entering or working in the same room where lyssaviruses or infected animals are used. The presence of virus-neutralizing antibodies in vaccinated individuals should be ascertained.^{112,113} Prompt administration of post-exposure booster vaccinations is recommended following recognized exposures in previously vaccinated individuals per current guidelines.^{112,113}

In cases where it is not possible to open the skull or remove the brain within a BSC, such as an autopsy or routine diagnostics, use appropriate methods and personal protective equipment (PPE), including dedicated laboratory clothing, heavy or chainmail gloves to avoid cuts or sticks from cutting instruments or bone fragments, and an N95 respirator combined with a face shield or a PAPR to protect the skin and mucous membranes of the eyes, nose, and mouth from exposure to tissue fragments or infectious droplets. Ample coverage of a 10% bleach solution should be used during and after the procedure for decontamination of exposed or contaminated surfaces and equipment.¹¹⁴

To prevent the generation of aerosols, a handsaw is recommended instead of an oscillating saw and contact of the saw with brain tissue is avoided. Additional primary containment and personnel precautions, such as those described for BSL-3, are indicated for activities with a high potential for droplet or aerosol production, and for activities involving large production quantities or high concentrations of infectious materials.

Table 1. Viruses currently included in the genus *Lyssavirus*

Species	Acronym	Recommended Biosafety Level
Aravan lyssavirus*	ARAV	2
Australian bat lyssavirus	ABLV	2
Bokeloh bat lyssavirus*	BBLV	2
Duvenhage lyssavirus	DUVV	2
European bat 1 lyssavirus	EBLV-1	2
European bat 2 lyssavirus	EBLV-2	2
Ikoma lyssavirus*	IKOV	3
Irkut lyssavirus	IRKV	2
Khujand lyssavirus*	KHUV	2
Lagos bat lyssavirus*	LBV	3
Mokola lyssavirus	MOKV	3
Rabies lyssavirus	RABV	2
Shimoni bat lyssavirus*	SHIBV	3
West Caucasian bat lyssavirus*	WCBV	3

*No human cases have been documented

Notes: This table is final as of publication, but it will be updated in future editions of BMBL to reflect the discovery of new, divergent lyssaviruses. When handled in a BSL-2 laboratory, BSL-3 practices and procedures should be used.

Special Issues

The CDC provides information on a variety of topics relating to Rabies virus, lyssaviruses, and pre/post-exposure prophylaxis online at <https://www.cdc.gov>. For non-emergency information on potential human infections, or treatment options, the CDC Rabies Duty Officer can be contacted at 404-639-1050 or CDC-Info can be reached at 800-232-4636.

Transfer of Agent Importation of this agent requires CDC and/or USDA importation permits. Domestic transport of this agent may require a permit from USDA APHIS VS. A DoC permit may be required for the export of this agent to another country. See [Appendix C](#) for additional information.

Retroviruses, including Human and Simian Immunodeficiency Viruses (HIV and SIV)

The family *Retroviridae* is divided into two subfamilies: 1) the *Orthoretrovirinae* with six genera including the genus *Lentivirus*, which includes HIV-1, HIV-2, and SIVs; the genus *Deltaretrovirus*, which includes human and simian T-lymphotropic viruses (HTLV-1, HTLV-2, HTLV-3, HTLV-4, and STLVs); and the genus *Betaretrovirus*, which includes simian type D retrovirus (SRV); and 2) the *Spumaretrovirinae*, which has recently been updated to contain five genera,¹¹⁵ including the genus *Simiispumavirus*, which includes simian foamy viruses (SFVs) that can occasionally infect humans in close contact with infected non-human primates (NHPs). Of these, only HIV and HTLV are pathogenic in humans and are now classified as known human carcinogens in the National Toxicology Program's Report on Carcinogens.⁵³ SIV/HIV genetic recombinants, known as SHIVs, are used in NHPs as models of HIV infection. The composition of SHIVs can vary but generally consist of an SIV genetic backbone containing specific HIV genes or gene regions.

Occupational Infections

Since 1991, data on occupational HIV transmission in health care workers (HCW) have been collected through a CDC-supported National HIV Surveillance system following a standardized case investigation protocol by state health department HIV staff with help from CDC.^{116,117} For surveillance purposes, laboratory workers are defined as those persons, including students and trainees, who have worked in a clinical or HIV laboratory setting anytime since 1978. Cases reported in this system are classified as either documented or possible occupational transmission. Those classified as documented occupational transmission had evidence of HIV seroconversion (i.e., a negative HIV-antibody test at the time of the exposure that converted to positive) following a discrete percutaneous or mucocutaneous occupational exposure to blood, body fluids, or other clinical or laboratory specimens. As of 2013, confirmed HIV infections among 58 HCWs were reported, including 20 laboratory workers, of

which only one involved a laboratory worker who sustained a needle exposure while working with an HIV-infected culture. There were another 49 HCWs exposed to HIV-infected blood, including four persons exposed to concentrated virus in a laboratory.^{116,117}

Workers have been reported to develop antibodies to simian immunodeficiency virus (SIV) following exposures.^{118–120} One case was associated with a needlestick that occurred while the worker was manipulating a contaminated needle after bleeding an SIV-infected macaque monkey.¹²¹ Another case involved a laboratory worker who handled macaque SIV-infected blood specimens without gloves. Though no specific incident was recalled, this worker had dermatitis on the forearms and hands while working with the infected blood specimens.¹¹⁸ A third worker was exposed to SIV-infected primate blood through a needlestick and subsequently developed antibodies to SIV.¹¹⁸ Of these three persons, only the worker exposed via dermatitis showed evidence of a persistent infection. To date, there is no evidence of illness or immunological incompetence in any of these workers. However, workers who have been occupationally exposed to HIV/SIV are recommended to immediately start an antiretroviral regimen. SFV infections in humans have occurred due to cross-species transmission following a variety of NHP exposures (e.g., working with NHPs, hunting and butchering NHPs) resulting in life-long, persistent infection but without any evidence for disease. Higher prevalences have been reported in individuals exposed to NHPs by bites, especially those reporting severe bite wounds. There has been a report of a laboratory infection while handling SFV.¹¹⁹ Laboratory infection with SRV has been reported in two workers but without molecular evidence of persistent infection or disease.¹²² SRV infection was also reported in one AIDS patient with lymphoma but without a history of NHP contact. Dual infection of a laboratory worker with SFV and SRV has also been reported but without evidence of secondary transmission of disease.¹²² STLV infection of laboratory workers has not been reported but is known to occur in persons who hunt NHPs.^{123,124}

Natural Modes of Infection

Retroviruses are widely distributed as infectious agents of vertebrates, including NHPs. Within the human population, the spread of HIV and HTLV is by close sexual contact, parenteral exposure through blood, blood-derived products, or other potentially infectious materials and from mother to child. Transmission of SFV and SRV from infected persons has not been reported.^{122,124,125}

SIV infection of NHPs rarely causes disease but can lead to immunodeficiency and AIDS-like illness similar to that seen in HIV-infected humans.¹²³ STLV infection of NHPs has been reported to cause T-cell lymphomas and leukemia, generalized skin lesions, and splenomegaly.¹²³ SRV-infected macaques can show symptoms similar to AIDS in humans, and this presentation is called simian AIDS (SAIDS).¹²³ SRV-infected macaques have also displayed retroperitoneal

fibromatosis, necrotizing stomatitis with osteomyelitis, acute death, splenomegaly, lymphadenopathy, and fibroproliferative disorders. Disease has not been associated with NHPs naturally infected with SFV.¹²³

Laboratory Safety and Containment Recommendations

HIV and HTLV have been isolated from blood, semen, saliva, urine, CSF, amniotic fluid, breast milk, cervical secretions, and tissues of infected persons and experimentally infected NHPs. Additionally, HIV has been isolated from tears of infected persons.

SIV, SHIV, and STLV have been isolated from blood, CSF, and a variety of tissues of infected NHPs.¹²³ Limited data exist on the concentration of virus in semen, saliva, cervical secretions, urine, breast milk, and amniotic fluid. Virus should be presumed to be present in all primate-derived tissue cultures, in animals experimentally infected or inoculated with SIV, SHIV, or STLV, in all materials derived from SIV, SHIV, and STLV cultures, and in/on all equipment and devices coming into direct contact with any of these materials.¹²⁶

SFV and SRV have been isolated from NHP blood and a variety of other tissues and can be cultured *in vitro*. Virus should be presumed to be present in all NHP-derived tissue cultures, in animals experimentally infected or inoculated with SFV or SRV, in all materials derived from SFV or SRV cultures, and in/on all equipment and devices coming into direct contact with any of these materials, similar to the handling of human clinical materials.¹²³

Although the risk of occupationally-acquired infection with retroviruses is primarily through exposure to infected blood, it is also prudent to wear gloves when manipulating other body fluids such as feces, saliva, urine, tears, sweat, vomitus, and human breast milk.

In the laboratory, retroviruses should be presumed to be present in all blood or clinical specimens contaminated with blood, in any unfixed tissue or organ (other than intact skin) from a human (living or dead), in retrovirus cultures, in all materials derived from retrovirus cultures, and in/on all equipment and devices coming into direct contact with any of these materials.

The skin (especially when scratches, cuts, abrasions, dermatitis, or other lesions are present) and mucous membranes of the eye, nose, and mouth should be considered as potential pathways for entry of these retroviruses during laboratory activities. It is unknown whether infection can occur via the respiratory tract. The need for using sharps in the laboratory should be evaluated. Needles, sharp instruments, broken glass, and other sharp objects must be carefully handled and properly discarded. Care must be taken to avoid spilling and splashing infected cell-culture liquid and other potentially infected materials.

Activities involving large-scale volumes or preparation of concentrated retroviruses, including HIV, SIV, or SHIV, should be conducted at BSL-3. Activities, such as producing research-laboratory-scale quantities of retroviruses, including HIV, SIV or SHIV, manipulating concentrated virus preparations, and conducting procedures that may produce droplets or aerosols, can be performed in a BSL-2 facility using BSL-3 practices.

Standard Precautions and personal protective equipment should be used when working with all body fluids even if the infection status of the individual or animal is unknown.¹²⁶ BSL-2 practices, containment equipment, and facilities are recommended for activities involving blood-contaminated clinical specimens, body fluids, and tissues from NHPs and humans infected with retroviruses. ABSL-2 is appropriate for NHPs and other animals infected with retroviruses, including HIV, SIV, or SHIV. Human serum from any source that is used as a control or reagent in a test procedure should be handled at BSL-2. Since 1996, post-exposure prophylaxis with antiretrovirals has been recommended to prevent infection following occupational exposures.¹²⁷

In addition to the aforementioned recommendations, persons working with any retrovirus, including HIV, SIV, or SHIV, or other bloodborne pathogens, should consult the OSHA Bloodborne Pathogen Standard.⁴³

Special Issues

It is recommended that all institutions establish written policies (e.g., treatment, prophylaxis protocols) regarding the management of laboratory exposure to retroviruses (HIV, SIV). See [Section VII](#) for additional information.

The risk associated with retroviral vector systems can vary significantly, especially lentiviral vectors. Because the risk associated with each gene transfer system can vary, it is recommended that all gene transfer protocols be reviewed by the institution's biosafety review committee or IBC.

Transfer of Agent Importation of this agent or materials containing this agent may require CDC and/or USDA importation permits. Domestic transport of this agent may require a permit from USDA APHIS VS. A DoC permit may be required for the export of this agent to another country. See [Appendix C](#) for additional information.

Severe Acute Respiratory Syndrome (SARS) and Middle East Respiratory Syndrome (MERS) Coronaviruses

Note: the 6th edition of the BMBL had already undergone final clearance at the time of the 2019 coronavirus pandemic. For the latest biosafety recommendations regarding work with SARS Coronavirus 2 (SARS-CoV-2) please consult the CDC COVID-19 website at (<https://www.cdc.gov/coronavirus/2019-nCoV/index.html>).

Several human coronaviruses have been identified that can be broadly classified into low and high pathogenicity. Low pathogenic human coronaviruses include 229E, HKU1, OC43, and NL63. High pathogenic coronaviruses include SARS and MERS-CoV. SARS is a viral respiratory illness caused by SARS-associated coronavirus (SARS-CoV) within the family *Coronaviridae*. SARS was retrospectively recognized in China in November 2002. Over the next few months, the illness spread to other Southeast Asian countries, North America, South America, and Europe following major airline routes.¹²⁸ The majority of disease-spread occurred in hospitals, among family members, and contacts of hospital workers. From November 2002 through July 2003, when the global outbreak was contained, a total of 8,098 probable cases of SARS were reported to the WHO from 29 countries.

In general, SARS patients present with fever (temperature greater than 100.4°F [$>38.0^{\circ}\text{C}$]), malaise, and myalgia quickly followed by respiratory symptoms including shortness of breath and cough. Ten to 20% of patients may have diarrhea. Review of probable cases indicates that the shortness of breath sometimes rapidly progresses to respiratory failure requiring ventilation. The case fatality rate is about 11%.

A second human coronavirus that causes severe disease, Middle East Respiratory Syndrome coronavirus (MERS-CoV), was first identified in Saudi Arabia in September 2012.^{128–130} Between 2012 and mid-2017, the WHO confirmed 1,952 cases with 693 deaths.¹³¹ Cases have been confirmed in 27 countries, though all cases have been linked to residents of the Arabian Peninsula.¹³¹ A wide clinical spectrum of MERS-CoV infections has been reported with asymptomatic infection identified during outbreaks, acute respiratory illness in most symptomatic patients, or severe presentation including rapidly progressive pneumonitis, respiratory failure, septic shock, or multi-organ failure resulting in death.¹³² Globally, 35–40% of cases reported to WHO have resulted in fatality. Common signs and symptoms at hospital admission include fever, chills/rigors, headache, non-productive cough, dyspnea, and myalgia.

Occupational Infections

Three different episodes of SARS-CoV transmission to laboratory workers occurred in 2003 and 2004 in research laboratories in Singapore, Taiwan, and Beijing.^{133–135} The events in 2004 involved two different laboratory personnel, with one case resulting in secondary and tertiary transmission of the virus to close contacts and healthcare providers.¹³³ Each occurrence was linked to a deviation from protocol or established laboratory practices.^{134,135} Additionally, no laboratory-associated cases have been associated with the routine processing of SARS or MERS diagnostic specimens for detection of virus; however, both coronaviruses represent an emerging infectious disease for which risk to the medical and laboratory community is not fully understood; therefore, caution

should be exercised when handling specimens that could potentially contain SARS or MERS-CoV.

Natural Modes of Infection

The mode of transmission in nature is not well understood. It appears that SARS is transmitted from person-to-person through close contact such as caring for, living with, or having direct contact with respiratory secretions or body fluids of a suspected or probable case.¹³⁶ SARS is thought to be spread primarily through droplets, aerosols, and possibly fomites. The natural reservoir for SARS-CoV is unknown.

MERS-CoV transmission can occur in hospital settings through close contact. In the community, transmission can occur between ill people and others through close contact. Transmission may also occur in the community through close contact with infected dromedary camels who may be a reservoir for the virus. The incubation period of MERS-CoV is usually two to five days; however, it can range from two to 14 days.¹³¹

Healthcare workers are at increased risk of acquiring SARS or MERS from an infected patient, especially if involved in pulmonary/respiratory procedures such as endotracheal intubation, nebulization of medications, diagnostic specimen collection, sputum induction, airway suctioning, positive-pressure ventilation, and high-frequency oscillatory ventilation.

Laboratory Safety and Containment Recommendations

SARS and MERS coronaviruses may be detected in respiratory, blood, urine, or stool specimens. The exact mode of transmission of coronavirus Laboratory-associated infections have not been established, but in clinical settings, the primary mode of transmission appears to be through direct or indirect contact of mucous membranes with infectious respiratory droplets.^{136,137}

SARS and MERS coronavirus propagation in cell culture and the initial characterization of viral agents recovered in cultures of clinical specimens must be performed at BSL-3. Respiratory protection should be used by all personnel.

Inoculation of animals for potential recovery of SARS- or MERS-CoV for characterization of putative SARS or MERS agents must be performed in ABSL-3 facilities using ABSL-3 work practices. Respiratory protection should be used.

Activities involving manipulation of untreated specimens should be performed in BSL-2 facilities using BSL-3 practices. In the rare event that a procedure or process involving untreated specimens cannot be conducted in a BSC, gloves, gown, eye protection, and respiratory protection should be used.

In clinical laboratories, respiratory specimens, whole blood, serum, plasma, and urine specimens should be handled using Standard Precautions at BSL-2.¹³⁸ Work using intact, full-length genomic RNA should be conducted at BSL-2.

In the event of any break in laboratory procedure or accident (e.g., accidental spillage of material suspected of containing SARS- or MERS-CoV), procedures for emergency exposure management and environmental decontamination should be immediately implemented and the supervisor should be notified. The worker and the supervisor, in consultation with occupational health or infection control personnel, should evaluate the break in procedure to determine if an exposure occurred. See Special Issues below.

Special Issues

Occupational Health Considerations Personnel working with the virus or samples containing or potentially containing the virus should be trained regarding the symptoms of SARS- and MERS-CoV infection and counseled to report any fever or respiratory symptoms to their supervisor immediately. Post-exposure baseline serum samples should be taken following any potential exposures. Personnel should be evaluated for possible exposure and the clinical features and course of their illness should be closely monitored for any signs or symptoms of disease. Institutions performing work with SARS- or MERS-CoV or handling specimens likely to contain the agent should develop and implement a specific occupational medical plan with respect to this agent. The plan, at a minimum, should contain procedures for managing:

- Deviation from protocol or established laboratory procedures;
- Exposed workers without symptoms;
- Exposed workers who develop symptoms within ten days of an exposure; and
- Symptomatic laboratory workers with no recognized exposure.

Further information and guidance regarding the development of a personnel exposure response plan are available from the CDC.¹³⁹ Laboratory workers who are believed to have had a laboratory exposure to SARS- or MERS-CoV should be evaluated, counseled about the risk of SARS- and MERS-CoV transmission to others, and monitored for fever or lower respiratory symptoms as well as for any of the following: sore throat, rhinorrhea, chills, rigors, myalgia, headache, and diarrhea.

Local and/or state public health departments should be promptly notified of laboratory exposures and illness in exposed laboratory workers.

Select Agent SARS-CoV is a Select Agent requiring registration with CDC or USDA for possession, use, storage, and/or transfer. See [Appendix F](#) for additional information.

Transfer of Agent The importation of SARS- and MERS-CoV into the United States and/or its interstate transport may be subject to the rules and regulations of the CDC Import Permit Program, CDC Division of Select Agents and Toxins, and/or the USDA Animal and Plant Health Inspection Service. The exportation of SARS-CoV may require a DoC permit.

References

1. Desmyter J, LeDuc JW, Johnson KM, Brasseur F, Deckers C, van Ypersele de Strihou C. Laboratory rat associated outbreak of haemorrhagic fever with renal syndrome due to Hantaan-like virus in Belgium. *Lancet*. 1983;2(8365–66):1445–8.
2. Lloyd G, Bowen ET, Jones N, Pendry A. HFRS outbreak associated with laboratory rats in UK. *Lancet*. 1984;1(8387):1175–6.
3. Tsai TF. Hemorrhagic fever with renal syndrome: mode of transmission to humans. *Lab Animal Sci*. 1987;37(4):428–30.
4. Umenai T, Lee HW, Lee PW, Saito T, Hongo M, Yoshinaga K, et al. Korean haemorrhagic fever in staff in an animal laboratory. *Lancet*. 1979;1(8130):1314–6.
5. Centers for Disease Control and Prevention. Laboratory management of agents associated with hantavirus pulmonary syndrome: interim biosafety guidelines. *MMWR Recomm Rep*. 1994;43(RR-7):1–7.
6. Lopez N, Padula P, Rossi C, Lazaro ME, Franze-Fernandez MT. Genetic identification of a new hantavirus causing severe pulmonary syndrome in Argentina. *Virology*. 1996;220(1):223–6.
7. Jameson LJ, Taori SK, Atkinson B, Levick P, Featherstone CA, van der Burgt G, et al. Pet rats as a source of hantavirus in England and Wales, 2013. *Euro Surveill*. 2013;18(9).pii:20415.
8. Kerins JL, Koske SE, Kazmierczak J, Austin C, Gowdy K, Dibernardo A, et al. Outbreak of Seoul Virus Among Rats and Rat Owners—United States and Canada, 2017. *MMWR Morb Mortal Wkly Rep*. 2018;67(4):131–4.
9. Martinez-Valdebenito C, Calvo M, Vial C, Mansilla R, Marco C, Palma RE, et al. Person-to-person household and nosocomial transmission of andes hantavirus, Southern Chile, 2011. *Emerg Infect Dis*. 2014;20(10):1629–36.
10. Padula PJ, Edelstein A, Miguel SD, Lopez NM, Rossi CM, Rabinovich RD. Hantavirus pulmonary syndrome in Argentina: molecular evidence of person to person transmission of Andes virus. *Virology*. 1998;241(2):323–30.
11. Hjelle B, Spiropoulou CF, Torrez-Martinez N, Morzunov S, Peters CJ, Nichol ST. Detection of Muerto Canyon virus RNA in peripheral blood mononuclear cells from patients with hantavirus pulmonary syndrome. *J Infect Dis*. 1994;170(4):1013–7.

12. Nichol ST, Spiropoulou CF, Morzunov S, Rollin PE, Ksiazek TG, Feldmann H, et al. Genetic identification of a hantavirus associated with an outbreak of acute respiratory illness. *Science*. 1993;262(5135):914–7.
13. Eaton BT, Broder CC, Middleton D, Wang LF. Hendra and Nipah viruses: different and dangerous. *Nat Rev Microbiol*. 2006;4(1):23–35.
14. Chua KB, Bellini WJ, Rota PA, Harcourt BH, Tamin A, Lam SK, et al. Nipah virus: a recently emergent deadly paramyxovirus. *Science*. 2000;288(5470):1432–5.
15. Chua KB, Goh KJ, Wong KT, Kamarulzaman A, Tan PS, Ksiazek TG, et al. Fatal encephalitis due to Nipah virus among pig-farmers in Malaysia. *Lancet*. 1999;354(9186):1257–9.
16. Paton NI, Leo YS, Zaki SR, Auchus AP, Lee KE, Ling AE, et al. Outbreak of Nipah-virus infection among abattoir workers in Singapore. *Lancet*. 1999;354(9186):1253–6.
17. Luby SP, Gurley ES. Epidemiology of Henipavirus disease in humans. *Curr Top Microbiol Immunol*. 2012;359:25–40.
18. Rahman MA, Hossain MJ, Sultana S, Homaira N, Khan SU, Rahman M, et al. Date palm sap linked to Nipah virus outbreak in Bangladesh, 2008. *Vector Borne Zoonotic Dis*. 2012;12(1):65–72.
19. World Health Organization [Internet]. Regional Office for South-East Asia; c2018 [cited 2018 Nov 27]. Nipah virus outbreaks in the WHO South-East Asia Region. Available from: http://www.searo.who.int/entity/emerging_diseases/links/nipah_virus_outbreaks_sear/en/
20. Hooper PT, Gould AR, Russell GM, Kattenbelt JA, Mitchell G. The retrospective diagnosis of a second outbreak of equine morbillivirus infection. *Aust Veterinary J*. 1996;74(3):244–5.
21. Murray K, Selleck P, Hooper P, Hyatt A, Gould A, Gleeson L, et al. A morbillivirus that caused fatal disease in horses and humans. *Science*. 1995;268(5207):94–7.
22. Rogers RJ, Douglas IC, Baldock FC, Glanville RJ, Seppanen KT, Gleeson LJ, et al. Investigation of a second focus of equine morbillivirus infection in coastal Queensland. *Aust Vet J*. 1996;74(3):243–4.
23. Selvey LA, Wells RM, McCormack JG, Ansford AJ, Murray K, Rogers RJ, et al. Infection of humans and horses by a newly described morbillivirus. *Med J Aust*. 1995;162(12):642–5.
24. Yu M, Hansson E, Shiell B, Michalski W, Eaton BT, Wang LF. Sequence analysis of the Hendra virus nucleoprotein gene: comparison with other members of the subfamily Paramyxovirinae. *J Gen Virol*. 1998;79(Pt 7): 1775–80.

25. Field H, Crameri G, Kung NY, Wang LF. Ecological aspects of hendra virus. *Curr Top Microbiol Immunol.* 2012;359:11–23.
26. Halpin K, Hyatt AD, Fogarty R, et al. Pteropid bats are confirmed as the reservoir hosts of henipaviruses: a comprehensive experimental study of virus transmission. *Am J Trop Med Hyg.* 2011;85(5):946–51.
27. Yob JM, Field H, Rashdi AM, Morrissy C, van der Heide B, Rota P, et al. Nipah virus infection in bats (order Chiroptera) in peninsular Malaysia. *Emer Infect Dis.* 2001;7(3):439–41.
28. Iccdr B. Outbreaks of encephalitis due to Nipah/Hendra-like viruses, Western Bangladesh. *Health Sci Bull.* 2003;1:1–6.
29. Selvey L, Taylor R, Arklay A, Gerrard J. Screening of bat carers for antibodies to equine morbillivirus. *Comm Dis Intell.* 1996;20(22):477–8.
30. Luby SP. The pandemic potential of Nipah virus. *Antiviral Res.* 2013;100(1):38–43.
31. Chua KB, Lam SK, Goh KJ, Hooi PS, Ksiazek TG, Kamarulzaman A, et al. The presence of Nipah virus in respiratory secretions and urine of patients during an outbreak of Nipah virus encephalitis in Malaysia. *J Infect.* 2001;42(1):40–3.
32. Wong KT, Shieh WJ, Zaki SR, Tan CT. Nipah virus infection, an emerging paramyxoviral zoonosis. *Springer Semin Immunopathol.* 2002;24(2):215–28.
33. Mounts AW, Kaur H, Parashar UD, Ksiazek TG, Cannon D, Arokiasamy JT, et al. A cohort study of health care workers to assess nosocomial transmissibility of Nipah virus, Malaysia, 1999. *J Infect Dis.* 2001;183(5):810–3.
34. Pike RM. Laboratory-associated infections: incidence, fatalities, causes, and prevention. *Annu Rev Microbiol.* 1979;33:41–66.
35. Schillie S, Murphy TV, Sawyer M, Ly K, Hughes E, Jiles R, et al. CDC guidance for evaluating health-care personnel for Hepatitis B virus protection and for administering postexposure management. *MMWR Recomm Rep.* 2013;62(RR-10):1–19.
36. Centers for Disease Control and Prevention [Internet]. Atlanta (GA): Division of Viral Hepatitis and National Center for HIV/AIDS, Viral Hepatitis, STD, and TB Prevention; c2018 [cited 2018 Nov 30]. Hepatitis B Questions and Answers for Health Professionals. Available from: <https://www.cdc.gov/hepatitis/hbv/hbvfaq.htm#overview>
37. Centers for Disease Control and Prevention. Recommendations for follow-up of health-care workers after occupational exposure to Hepatitis C virus. *MMWR Morb Mortal Wkly Rep.* 1997;46(26):603–6.

38. Centers for Disease Control and Prevention. Recommendation of the Immunization Practices Advisory Committee (ACIP). Inactivated Hepatitis B virus vaccine. *MMWR Morb Mortal Wkly Rep.* 1982;31(24):317–22, 327–8.
39. Chung H, Kudo M, Kumada T, Katsushima S, Okano A, Nakamura T, et al. Risk of HCV transmission after needlestick injury, and the efficacy of short-duration interferon administration to prevent HCV transmission to medical personnel. *J Gastroenterol.* 2003;38(9):877–9.
40. Buster E, van der Eijk AA, Schalm SW. Doctor to patient transmission of Hepatitis B virus: implications of HBV DNA levels and potential new solutions. *Antiviral Res.* 2003;60(2):79–85.
41. Binka M, Paintsil E, Patel A, Lindenbach BD, Heimer R. Survival of Hepatitis C Virus in Syringes Is Dependent on the Design of the Syringe-Needle and Dead Space Volume. *PLoS One.* 2015;10(11):e0139737. Erratum in: *PLoS One.* 2015;10(12):e0146088.
42. Paintsil E, Binka M, Patel A, Lindenbach BD, Heimer R. Hepatitis C virus maintains infectivity for weeks after drying on inanimate surfaces at room temperature: implications for risks of transmission. *J Infect Dis.* 2014;209(8):1205–11.
43. Occupational exposure to bloodborne pathogens; correction—OSHA. Final rule, correction. *Fed Regist.* 1992;57(127):29206.
44. Cohen JI, Davenport DS, Stewart JA, Deitchman S, Hilliard JK, Chapman LE, et al. Recommendations for prevention of and therapy for exposure to B virus (Cercopithecine herpesvirus 1). *Clin Infect Dis.* 2002;35(10):1191–203.
45. Calvo C, Friedlander S, Hilliard J, Swarts R, Nielsen J, Dhindsa H, et al. Case Report: Reactivation Of Latent B Virus (Macacine Herpesvirus 1) Presenting As Bilateral Uveitis, Retinal Vasculitis And Necrotizing Herpetic Retinitis. *Investigative Ophthalmology & Visual Science.* 2011;52(14):2975.
46. Centers for Disease Control and Prevention [Internet]. Atlanta (GA): National Center for Immunization and Respiratory Diseases, Division of Viral Diseases; c2016 [cited 2018 Nov 30]. B Virus (herpes B, monkey B virus, herpesvirus simiae, and herpesvirus B). Available from: <https://www.cdc.gov/herpesvirus/cause-incidence.html>
47. Centers for Disease Control and Prevention. Fatal Cercopithecine herpesvirus 1 (B virus) infection following a mucocutaneous exposure and interim recommendations for worker protection. *MMWR Morb Mortal Wkly Rep.* 1998;47(49):1073–6, 1083.
48. Committee on Occupational Health and Safety in the Care and Use of Non-Human Primates. *Occupational Health and Safety in the Care and Use of Nonhuman Primates.* Washington (DC): The National Academies Press; 2003.

49. Guidelines for prevention of Herpesvirus simiae (B virus) infection in monkey handlers. The B Virus Working Group. *J Med Primatol.* 1988;17(2):77–83.
50. Huff JL, Eberle R, Capitanio J, Zhou SS, Barry PA. Differential detection of B virus and rhesus cytomegalovirus in rhesus macaques. *J Gen Virol.* 2003;84(Pt 1):83–92.
51. Roizman B, Pellett PE. Herpesviridae. In: Knipe DM, Howley PM, editors. *Fields Virology.* Vol 2. 6th ed. Philadelphia: Lippincott Williams & Wilkins; 2013. p. 1802–22.
52. Heymann DL, editor. *Control of Communicable Diseases Manual.* 20th ed. Washington (DC): American Public Health Association; 2015.
53. U.S. Department of Health and Human Services [Internet]. Washington (DC): National Toxicology Program; c2018 [cited 2018 Dec 3]. 14th Report on Carcinogens. Available from: <https://ntp.niehs.nih.gov/pubhealth/roc/index-1.html#toc1>
54. Cohen, JI. Human herpesvirus types 6 and 7. In: Bennett JE, Dolin R, Blaser MJ, editors. *Mandell, Douglas, and Bennett's principles and practice of infectious diseases.* Vol 2. 8th ed. Philadelphia: Elsevier; 2015. p. 1772–6.
55. Chang Y, Cesarman E, Pessin MS, Lee F, Culpepper J, Knowles DM, et al. Identification of herpesvirus-like DNA sequences in AIDS-associated Kaposi's sarcoma. *Science.* 1994;266(5192):1865–9.
56. Dukers NH, Rezza G. Human herpesvirus 8 epidemiology: what we do and do not know. *AIDS.* 2003;17(12):1717–30.
57. Plancoulaine S, Abel L, van Beveren M, Trequet DA, Joubert M, Tortevoeye P, et al. Human herpesvirus 8 transmission from mother to child and between siblings in an endemic population. *Lancet.* 2000;356(9235):1062–5.
58. Regamey N, Tamm M, Wernli M, Witschi A, Thiel G, Cathomas G, et al. Transmission of human herpesvirus 8 infection from renal-transplant donors to recipients. *N Engl J Med.* 1998;339(19):1358–63.
59. Luppi M, Barozzi P, Guaraldi G, Ravazzini L, Rasini V, Spano C, et al. Human herpesvirus 8-associated diseases in solid-organ transplantation: importance of viral transmission from the donor. *Clin Infect Dis.* 2003;37(4):606–7.
60. Mbulaiteye SM, Biggar RJ, Bakaki PM, Pfeiffer RM, Whitby D, Owor AM, et al. Human herpesvirus 8 infection and transfusion history in children with sickle-cell disease in Uganda. *J Natl Cancer Inst.* 2003;95(17):1330–5.

61. Marin M, Guris D, Chaves SS, Schmid S, Seward JF; Advisory Committee on Immunization Practices, Centers for Disease Control and Prevention. Prevention of Varicella: recommendations of the Advisory Committee on Immunization Practices (ACIP). *MMWR Recomm Rep.* 2007;56(RR-4):1–40.
62. Treanor JJ. Influenza virus. In: Bennett JE, Dolin R, Blaser MJ, editors. *Mandell, Douglas, and Bennett's principles and practice of infectious diseases.* Vol 2. 8th ed. Philadelphia: Elsevier; 2015. p. 2000–4.
63. Kwong JC, Schwartz KL, Campitelli MA. Acute Myocardial Infarction after Laboratory-Confirmed Influenza Infection. *N Engl J Medicine.* 2018;378(26):2540–1.
64. Sellers SA, Hagan RS, Hayden FG, Fischer WA 2nd. The hidden burden of influenza: A review of the extra-pulmonary complications of influenza infection. *Influenza Other Respir Viruses.* 2017;11(5):372–93.
65. Uyeki TM, Katz JM, Jernigan DB. Novel influenza A viruses and pandemic threats. *Lancet.* 2017;389(10085):2172–74.
66. Hung MA, Epperson S, Biggerstaff M, Allen D, Balish A, Barnes N, et al. Outbreak of variant influenza A(H3N2) virus in the United States. *Clin Infect Dis.* 2013;57(12):1703–12.
67. Wang H, Feng Z, Shu Y, Yu H, Zhou L, Zu R, et al. Probable limited person-to-person transmission of highly pathogenic avian influenza A(H5N1) virus in China. *Lancet.* 2008;371(9622):1427–34.
68. Zhou L, Chen E, Bao C, Xiang N, Wu J, Wu S, et al. Clusters of Human Infection and Human-to-Human Transmission of Avian Influenza A(H7N9) Virus, 2013–2017. *Emerg Infect Dis.* 2018;24(2).
69. Influenza. In: Heymann DL, editor. *Control of communicable diseases manual.* 20th ed. Washington (DC): American Public Health Association; 2015. p. 306–22.
70. Dowdle WR, Hattwick MA. Swine influenza virus infections in humans. *J. Infect Dis.* 1977;136 Suppl:S386–5399.
71. Tang JW, Shetty N, Lam TT, Hon KL. Emerging, novel, and known influenza virus infections in humans. *Infect Dis Clin North Am.* 2010;24(3):603–17.
72. Bouvier NM. Animal models for influenza virus transmission studies: a historical perspective. *Curr Opin Virol.* 2015;13:101–8.
73. Lee CT, Slavinski S, Schiff C, Merlino M, Daskalakis D, Liu D, et al. Outbreak of Influenza A(H7N2) Among Cats in an Animal Shelter With Cat-to-Human Transmission—New York City, 2016. *Clin Infect Dis.* 2017;65(11):1927–29.
74. Webster RG, Geraci J, Petursson G, Skirnisson K. Conjunctivitis in human beings caused by influenza A virus of seals. *N Engl J Med.* 1981;304(15):911.

75. Fiore AE, Shay DK, Broder K, Iskander JK, Uyeki TM, Mootrey G, et al. Prevention and control of influenza: recommendations of the Advisory Committee on Immunization Practices (ACIP), 2008. *MMWR Recomm Rep.* 2008;57(RR-7):1–60.
76. Su S, Gu M, Liu D, Cui J, Gao GF, Zhou J, et al. Epidemiology, Evolution, and Pathogenesis of H7N9 Influenza Viruses in Five Epidemic Waves since 2013 in China. *Trends Microbiol.* 2017;25(9):713–28.
77. Pearce MB, Belser JA, Gustin KM, Pappas C, Houser KV, Sun X, et al. Seasonal trivalent inactivated influenza vaccine protects against 1918 Spanish influenza virus infection in ferrets. *J Virol.* 2012;86(13):7118–25.
78. Hancock K, Veguilla V, Lu X, Zhong W, Butler EN, Sun H, et al. Cross-reactive antibody responses to the 2009 pandemic H1N1 influenza virus. *N Engl J Med.* 2009;361(20):1945–52.
79. Medina RA, Manicassamy B, Stertz S, Seibert CW, Hai R, Belshe RB, et al. Pandemic 2009 H1N1 vaccine protects against 1918 Spanish influenza virus. *Nat Commun.* 2010;1:28.
80. Science Safety Security [Internet]. Washington (DC): U.S. Department of Health & Human Services; c2017 [cited 2018 Dec 3]. Dual Use Research of Concern. Available from: <https://www.phe.gov/s3/dualuse/Pages/default.aspx>
81. Bowen GS, Calisher CH, Winkler WG, Kraus AL, Fowler EH, Garman RH, et al. Laboratory studies of a lymphocytic choriomeningitis virus outbreak in man and laboratory animals. *Am J Epidemiol.* 1975;102(3):233–40.
82. Jahrling PB, Peters CJ. Lymphocytic choriomeningitis virus. A neglected pathogen of man. *Arch Pathol Lab Med.* 1992;116(5):486–8.
83. Knust B, Ströher U, Edison L, Albarino CG, Lovejoy J, Armeanu E, et al. Lymphocytic Choriomeningitis Virus in Employees and Mice at Multipremises Feeder-Rodent Operation, United States, 2012. *Emerg Infect Dis.* 2014;20(2):240–7.
84. Reiserová L, Kaluzová M, Kaluz S, Willis AC, Zavada J, Zavadská E, et al. Identification of MaTu-MX Agent as a New Strain of Lymphocytic Choriomeningitis Virus (LCMV) and Serological Indication of Horizontal Spread of LCMV in Human Population. *Virology.* 1999;257(1):73–83.
85. Fischer SA, Graham MB, Kuehnert MJ, Kotton CN, Srinivasan A, Marty FM, Comer JA, et al. Transmission of lymphocytic choriomeningitis virus by organ transplantation. *N Engl J Med.* 2006;354(21):2235–49.
86. Macneil A, Stroher U, Farnon E, Campbell S, Cannon D, Paddock CD, et al. Solid organ transplant-associated lymphocytic choriomeningitis, United States, 2011. *Emerg Infect Dis.* 2012;18(8):1256–62.

87. Mathur G, Yadav K, Ford B, Schafer IJ, Basavaraju SV, Knust B, et al. High clinical suspicion of donor-derived disease leads to timely recognition and early intervention to treat solid organ transplant-transmitted lymphocytic choriomeningitis virus. *Transpl Infect Dis.* 2017;19(4).
88. Palacios G, Druce J, Du L, Tran T, Birch C, Briese T, et al. A new arenavirus in a cluster of fatal transplant-associated diseases. *N Engl J Med.* 2008;358(10):991–8.
89. Centers for Disease Control and Prevention. Lymphocytic choriomeningitis virus infection in organ transplant recipients—Massachusetts, Rhode Island, 2005. *MMWR Morb Mortal Wkly Rep.* 2005;54(21):537–9.
90. Wright R, Johnson D, Neumann M, Ksiazek TG, Rollin P, Keech RV, et al. Congenital lymphocytic choriomeningitis virus syndrome: a disease that mimics congenital toxoplasmosis or Cytomegalovirus infection. *Pediatrics.* 1997;100(1):E9.
91. Dowdle WR, Gary HE, Sanders R, van Loon AM. Can post-eradication laboratory containment of wild polioviruses be achieved?. *Bull World Health Organ.* 2002;80(4):311–6.
92. Pike RM. Laboratory-associated infections: summary and analysis of 3921 cases. *HiLth Lab Sci.* 1976;13(2):105–14.
93. Mulders MN, Reimerink JH, Koopmans MP, van Loon AM, van der Avoort HG. Genetic analysis of wild-type poliovirus importation into The Netherlands (1979–1995). *J Infect Dis.* 1997;176(3):617–24.
94. Previsani N, Singh H, St Pierre J, Boualam L, Fournier-Caruana J, Sutter RW, et al. Progress Toward Containment of Poliovirus Type 2—Worldwide, 2017. *MMWR Morb Mortal Wkly Rep.* 2017;66(24):649–52.
95. Prevots DR, Burr RK, Sutter RW, Murphy TV; Advisory Committee on Immunization Practices. Poliomyelitis prevention in the United States. Updated recommendations of the Advisory Committee on Immunization Practices (ACIP). *MMWR Recomm Rep.* 2000;49(RR-5):1–22; quiz CE1–7.
96. World Health Organization. WHO Global Action Plan to minimize poliovirus facility-associated risk after type-specific eradication of wild polioviruses and sequential cessation of oral polio vaccine use. Geneva: WHO Press; 2015.
97. World Health Organization. Guidance for non-poliovirus facilities to minimize risk of sample collections potentially infectious for polioviruses. Geneva: World Health Organization; 2018.
98. Annex 2. In: World Health Organization. Guidance for non-poliovirus facilities to minimize risk of sample collections potentially infectious for polioviruses. Geneva: World Health Organization; 2018. p. 18–9.

99. Damon IK. Poxviruses. In: Knipe DM, Howley PM, editors. *Fields Virology*. Vol 2. 6th ed. Philadelphia: Lippincott Williams & Wilkins; 2013. p. 2160–84.
100. Lewis-Jones S. Zoonotic poxvirus infections in humans. *Curr Opin Infect Dis*. 2004;17(2):81–9.
101. Reed KD, Melski JW, Graham MB, Regnery RL, Sotir MJ, Wegner MV, et al. The detection of monkeypox in humans in the Western Hemisphere. *N Engl J Med*. 2004;350(4):342–50.
102. MacNeil A, Reynolds MG, Damon IK. Risks associated with vaccinia virus in the laboratory. *Virology*. 2009;385(1):1–4.
103. Wharton M, Strikas RA, Harpaz R, Rotz LD, Schwartz B, Casey CG, et al. Recommendations for using smallpox vaccine in a pre-event vaccination program. Supplemental recommendations of the Advisory Committee on Immunization Practices (ACIP) and the Healthcare Infection Control Practices Advisory Committee (HICPAC). *MMWR Recomm Rep*. 2003;52(RR-7):1–16.
104. Peres MG, Bacchiega TS, Appolinario CM, Vicente AF, Mioni MSR, Ribeiro BLD, et al. Vaccinia Virus in Blood Samples of Humans, Domestic and Wild Mammals in Brazil. *Viruses*. 2018;10(1). pii: E42.
105. Casey C, Vellozzi C, Mootrey GT, Chapman LE, McCauley M, Roper MH, et al. Surveillance guidelines for smallpox vaccine (vaccinia) adverse reactions. *MMWR Recomm Rep*. 2006;55(RR-1):1–16.
106. Petersen BW, Harms TJ, Reynolds MG, Harrison LH. Use of Vaccinia Virus Smallpox Vaccine in Laboratory and Health Care Personnel at Risk for Occupational Exposure to Orthopoxviruses—Recommendations of the Advisory Committee on Immunization Practices (ACIP), 2015. *MMWR Morb Mortal Wkly Rep*. 2016;65(10):257–62.
107. National Institutes of Health. NIH Guidelines for Research Involving Recombinant or Synthetic Nucleic Acid Molecules (NIH Guidelines). Bethesda (MD): National Institutes of Health, Office of Science Policy; 2019.
108. Rupprecht CE, Hanlon CA, Hemachudha T. Rabies re-examined. *Lancet Infect Dis*. 2002;2(6):327–43.
109. International Committee on Taxonomy of Viruses [Internet]. Taxonomy; c2019 [cited 2019 Mar 12]. *Virus Taxonomy: 2018b Release*. Available from: <https://talk.ictvonline.org/taxonomy/>
110. Winkler WG, Fashinell TR, Leffingwell L, Howard P, Conomy P. Airborne rabies transmission in a laboratory worker. *JAMA*. 1973;226(10):1219–21.
111. Centers for Disease Control and Prevention. Rabies in a laboratory worker—New York. *MMWR Morb Mortal Wkly Rep*. 1977;26(22):183–4.

112. Manning SE, Rupprecht CE, Fishbein D, Hanlon CA, Lumlertdacha B, Guerra M, et al. Human rabies prevention—United States, 2008: Recommendations of the Advisory Committee on Immunization Practices. *MMWR Recomm Rep.* 2008;57(RR-3):1–28.
113. Rupprecht CE, Gibbons RV. Clinical practice. Prophylaxis against rabies. *N Engl Journal Med.* 2004;351(25):2626–35.
114. Centers for Disease Control and Prevention. Human rabies—Kentucky/Indiana, 2009. *MMWR Morb Mortal Wkly Rep.* 2010;59(13):393–6.
115. Khan AS, Bodem J, Buseyne F, Gessain A, Johnson W, Kuhn JH, et al. Spumaretroviruses: Updated taxonomy and nomenclature. *Virology.* 2018;516:158–64.
116. Centers for Disease Control and Prevention. HIV/AIDS surveillance report. U.S. HIV and AIDS cases reported through June 1998. Midyear Edition. 1998;10(1).
117. Joyce MP, Kuhar D, Brooks JT. Notes from the field: Occupationally acquired HIV infection among health care workers—United States, 1985–2013. *MMWR Morb Mortal Wkly Rep.* 2015;63(53):1245–6.
118. Centers for Disease Control and Prevention. Seroconversion to simian immunodeficiency virus in two laboratory workers. *MMWR Morb Mortal Wkly Rep.* 1992;41(36):678–81.
119. Schweizer M, Turek R, Hahn H, Schliephake A, Netzker KO, Eder G, et al. Markers of foamy virus infections in monkeys, apes, and accidentally infected humans: appropriate testing fails to confirm suspected foamy virus prevalence in humans. *AIDS Res Hum Retroviruses.* 1995;11(1):161–70.
120. Sotir M, Switzer W, Schable C, Schmitt J, Vitek C, Khabbaz RF. Risk of occupational exposure to potentially infectious nonhuman primate materials and to simian immunodeficiency virus. *J Med Primatol.* 1997;26(5):233–40.
121. Khabbaz RF, Rowe T, Murphey-Corb M, Heneine WM, Schable CA, George JR, et al. Simian immunodeficiency virus needlestick accident in a laboratory worker. *Lancet.* 1992;340(8814):271–3.
122. Lerche NW, Switzer WM, Yee JL, Shanmugam V, Rosenthal AN, Chapman LE, et al. Evidence of infection with simian type D retrovirus in persons occupationally exposed to nonhuman primates. *J Virol.* 2001;75(4):1783–9.
123. Murphy HW, Miller M, Ramer J, Travis D, Barbiere R, Wolfe ND, et al. Implications of simian retroviruses for captive primate population management and the occupational safety of primate handlers. *J Zoo Wildl Med.* 2006;37(3):219–33.
124. Switzer WM, Bhullar V, Shanmugam V, Conge ME, Parekh B, Lerche NW, et al. Frequent simian foamy virus infection in persons occupationally exposed to nonhuman primates. *J Virol.* 2004;78(6):2780–9.

125. Switzer WM, Heneine W. Foamy Virus. In: Liu D, editor. *Molecular Detection of Human Viral Pathogens*: Boca Raton: CRC Press; 2011. p. 131–46.
126. Centers for Disease Control and Prevention [Internet]. Atlanta (GA): National Center for Zoonotic and Emerging Infectious Diseases, Division of Healthcare Quality Promotion; c2016. Standard Precautions for All Patient Care. Available from: <https://www.cdc.gov/infectioncontrol/basics/standard-precautions.html>.
127. Kuhar DT, Henderson DK, Struble KA, Heneine W, Thomas V, Cheever LW, et al. Updated US Public Health Service guidelines for the management of occupational exposures to human immunodeficiency virus and recommendations for postexposure prophylaxis. *Infect Control Hosp Epidemiol*. 2013;34(9):875–93. Erratum in: *Infect Control Hosp Epidemiol*. 2013;34(11):1238.
128. van Boheemen S, de Graaf M, Lauber C, Bestebroer TM, Raj VS, Zaki AM, et al. Genomic characterization of a newly discovered coronavirus associated with acute respiratory distress syndrome in humans. *MBio*. 2012;3(6). pii: e00473–12.
129. Assiri A, Al-Tawfiq JA, Al-Rabeeh AA, Al-Rabiah FA, Al-Hajjar S, Al-Barrack A, et al. Epidemiological, demographic, and clinical characteristics of 47 cases of Middle East respiratory syndrome coronavirus disease from Saudi Arabia: a descriptive study. *Lancet Infect Dis*. 2013;13(9):752–61.
130. Centers for Disease Control and Prevention. Severe respiratory illness associated with a novel coronavirus—Saudi Arabia and Qatar, 2012. *MMWR Morb Mortal Wkly Rep*. 2012;61(40):820.
131. World Health Organization [Internet]. Geneva. c2018 [cited 2018 Dec 3]. Middle East respiratory syndrome coronavirus (MERS-CoV). Available from: <https://www.who.int/emergencies/mers-cov/en/>
132. Rasmussen SA, Gerber SI, Swerdlow DL. Middle East respiratory syndrome coronavirus: update for clinicians. *Clin Infect Dis*. 2015;60(11):1686–9.
133. Centers for Disease Control and Prevention [Internet]. Atlanta (GA): National Center for Immunization and Respiratory Diseases, Division of Viral Diseases; c2017 [cited 2018 Dec 3]. Severe Acute Respiratory Syndrome (SARS). Available from: <https://www.cdc.gov/sars/>
134. American Biological Safety Association [Internet]. c2014 [cited 2018 Dec 3]. Laboratory-Acquired Infection (LAI) Database. Available from: <https://my.absa.org/LAI>
135. Lim PL, Kurup A, Gopalakrishna G, Chan KP, Wong CW, Ng LC, et al. Laboratory-acquired severe acute respiratory syndrome. *N Engl J Med*. 2004;350(17):1740–5.

136. SARS, MERS, and other coronavirus infections. In: Heymann DL, editor. Control of Communicable Diseases Manual. 20th ed. Washington (DC): American Public Health Association; 2015. p. 539–49.
137. Chow PK, Ooi EE, Tan HK, Ong KW, Sil BK, Teo M, et al. Healthcare worker seroconversion in SARS outbreak. *Emerg Infect Dis*. 2004;10(2):249–50.
138. Centers for Disease Control and Prevention [Internet]. Atlanta (GA): National Center for Zoonotic and Emerging Infectious Diseases, Division of Healthcare Quality Promotion; c2016. Standard Precautions for All Patient Care. Available from: <https://www.cdc.gov/infectioncontrol/basics/standard-precautions.html>.
139. Centers for Disease Control and Prevention. Severe Acute Respiratory Syndrome. Public Health Guidance for Community-Level Preparedness and Response to Severe Acute Respiratory Syndrome (SARS) Version 2. Supplement F: Laboratory Guidance. Department of Health & Human Services; 2004.

Section VIII-F: Arboviruses and Related Zoonotic Viruses

In 1979, and again in 1985, the American Committee on Arthropod-Borne Viruses (ACAV) Subcommittee on Arbovirus Laboratory Safety (SALS) provided biosafety recommendations for each of the approximately 500 viruses registered in the International Catalogue of Arboviruses, including Certain Other Viruses of Vertebrates.¹ Since the last print publication of the Catalog, SALS, the CDC, and the NIH have periodically reviewed these viruses as well as newly identified arboviruses and provided recommended biosafety practices and containment for arboviruses identified or registered since that time. These recommendations are based, in part, on risk assessments derived from information provided by a worldwide survey of laboratories working with arboviruses, newly published reports on the viruses, reports of laboratory infections, and discussions with scientists working with each virus.

A series of significant tables are provided throughout [Section VIII-F](#). Table 1 contains a list of vaccine strains of viruses that may be handled at BSL-2. Table 3 provides an alphabetical listing of the recognized arboviruses at the time of publication and includes the common name, acronym, virus family or genus, Biosafety Level (BSL) recommendation, basis for the rating, and antigenic group (if known).² Many of the organisms are classified as Select Agents and require special security measures to possess, use, or transfer; see [Appendix F](#) for additional information. Table 2 provides a key for the SALS basis for assignment of viruses listed in Tables 3 and 4. Table 4 provides an alphabetical listing of the arthropod-only arboviruses and includes the common name, acronym, virus family or genus, BSL recommendation, basis for the rating, and whether the virus has been isolated. Table 5 provides a list of agents that may be handled at BSL-3 with HEPA-filtered exhaust air. The agents in Tables 1, 3, 4 and 5 require permits from APHIS, DOC, and/or CDC.

It is important to assess the risks of each member of the arbovirus family individually. While arboviral families may share many similarities, each can present their own unique biosafety risks. Viruses that have positive-sense single-stranded RNA carry unique infection risks that are not a consideration for other pathogens. Positive-sense viral RNA can directly cause infection since its RNA can serve as mRNA to direct viral protein synthesis by the host cell.³ Additionally, disinfection methods aimed at inactivating an enveloped virus may not be effective at rendering a positive-sense single-stranded RNA non-infectious.⁴

In addition to the true arboviruses (i.e., viruses that replicate in both vertebrates and invertebrates), a significant number of arthropod-only viruses (i.e., viruses not known to replicate in vertebrate cells) that are closely related to arboviral counterparts have been identified.⁵ While there is no evidence that these viruses

replicate or cause disease in vertebrate cells, most have not been characterized fully enough to confirm this and have been designated as “arthropod-only” based on genetic relationships. The infectivity of these viruses by routes of infection common to the laboratory may be unknown. For this reason, all of these viruses have been assigned Risk Group 2 (RG2) classification based on relationships to the small number that have been characterized. Table 4 lists these viruses as known to date. Table 3 also contains viruses from the family *Arenaviridae* that are rodent-borne with members known to cause hemorrhagic fever, including Lymphocytic choriomeningitis virus (see [Section VIII-E](#)), Guanarito, Junin, Lassa, Machupo, and Sabia virus. Also included are Orthohantaviruses, including Andes, Sin Nombre, and Hantaan, that can be transmitted to humans by rodent urine, saliva, or feces.

Agent summary statements have been included for certain arboviruses. They were submitted by a panel of experts for more detailed consideration due to one or more of the following factors:

- At the time of writing this edition, the organism represented an emerging public health threat in the United States;
- The organism presented unique biocontainment challenge(s) that required further detail; and/or
- The organism presented a significant risk of Laboratory-associated infection.

These recommendations were made in the winter of 2017; requirements for biosafety, shipping, and Select Agent registration can change. Please be sure to confirm the requirements with the appropriate Federal agency. If the pathogen of interest is one listed in [Appendix D](#), contact APHIS for additional biosafety requirements. APHIS guidance may supersede the information found in this section.

Recommendations for the containment of infected arthropod vectors were drafted by a subcommittee of the American Committee on Medical Entomology (ACME) and updated in 2019 as the Arthropod Containment Guidelines version 3.2; see [Appendix E](#) for additional information.⁶

Some commonly used vaccine strains for which attenuation has been firmly established are recognized by SALS; these vaccine strains may be handled safely at BSL-2 and are listed in Table 1.

Table 1. Vaccine Strains of Specific Viruses that May Be Handled at BSL-2

Virus	Vaccine Strain
<i>Chikungunya</i>	181/25
<i>Junin</i>	Candid
Rift Valley fever	#1 MP-12
Venezuelan equine encephalomyelitis	TC83 & V3526
<i>Yellow fever</i>	17-D
Japanese encephalitis	14-14-2

Based on the recommendations listed with the tables, the following guidelines should be adhered to where applicable.

Risk Group 2 Viruses with BSL-2 Containment Recommended

The recommendations for conducting work with the viruses listed in Table 3 at BSL-2 are based on the existence of historical laboratory experience adequate to assess the risks when working with this group of viruses. This indicates 1) no overt Laboratory-associated infections are reported; 2) infections resulted from exposures other than by infectious aerosols; or 3) if disease from aerosol exposure is documented, it is uncommon.

Laboratory Safety and Containment Recommendations

Agents listed in this group may be present in blood, CSF, various tissues, and/or infected arthropods depending on the agent and the stage of infection. The primary laboratory hazards are accidental parenteral inoculation, contact of the virus with broken skin or mucous membranes, and bites of infected laboratory rodents or arthropods. Properly maintained BSCs, preferably Class II, or other appropriate personal protective equipment (PPE) or physical containment devices are used whenever procedures with a potential for creating infectious aerosols or splashes are conducted.

BSL-2 practices, containment equipment, and facilities are recommended for activities with potentially infectious clinical materials and arthropods and for manipulations of infected tissue cultures, embryonated hen's eggs, and small vertebrate animals.

Large quantities and/or high concentrations of any virus have the potential to overwhelm both innate immune mechanisms and vaccine-induced immunity. When a virus normally handled at BSL-2 is being produced in large quantities or in high concentrations, additional risk assessment is required. This might indicate BSL-3 practices, including respiratory protection, based on a risk assessment.

West Nile virus (WNV) and St. Louis Encephalitis virus (SLE) risk assessments have been revised to indicate BSL-2 containment may be acceptable for routine work. Prior to moving existing work with either virus from BSL-3 laboratories to BSL-2, a thorough assessment should be made to assess the possible risk from contamination of samples with other agents needing BSL-3 containment.

Risk Group 3 Viruses with BSL-3 Containment Recommended

The recommendations for viruses listed in Table 3 that require BSL-3 containment are based on multiple criteria. SALS considered the laboratory experience for some viruses to be inadequate to assess risk, regardless of the available information regarding disease severity. In some cases, SALS recorded overt Laboratory-associated infections (LAI) transmitted by the aerosol route in the absence or non-use of protective vaccines and considered that the natural disease in humans is potentially severe, life-threatening, or causes residual damage.¹ Arboviruses also were classified as requiring BSL-3 containment if they caused diseases in domestic animals in countries outside of the United States.

Laboratory Safety and Containment Recommendations

The agents listed in this group may be present in blood, CSF, urine, semen, and exudates, depending on the specific agent and stage of disease. The primary laboratory hazards are exposure to aerosols of infectious solutions and animal bedding, accidental parenteral inoculation, and contact with broken skin. Some of these agents (e.g., VEE virus) may be relatively stable in dried blood or exudates.

BSL-3 practices, containment equipment, and facilities are recommended for activities using potentially infectious clinical materials and infected tissue cultures, animals, or arthropods.

A licensed attenuated live virus is available for immunization against yellow fever. It is recommended for all personnel who work with this agent or with infected animals and for those entering rooms where the agents or infected animals are present.

BSL-3 containment is still recommended for Junin virus provided that all at-risk personnel are immunized and the laboratory is equipped with HEPA-filtered exhaust.

SALS also has reclassified Central European tick-borne encephalitis viruses (TBEV-CE subtype) as needing BSL-3 containment, provided all at-risk personnel are immunized. TBEV-CE subtype refers to the following group of very closely related, if not essentially identical, tick-borne flaviviruses isolated from Czechoslovakia, Finland, and Russia: Absettarov, Hanzalova, Hypr, and Kumlinge viruses. While there is a vaccine available that confers immunity to the TBEV-CE subtype group of genetically (>98%) homogeneous viruses, the efficacy of this

vaccine against Russian spring-summer encephalitis virus (RSSEV) (TBEV-FE; Far Eastern subtype) infections has not been established. Thus, the TBEV-CE subtype group of viruses has been reclassified as needing BSL-3 containment when personnel are immunized with TBEV-CE subtype vaccine, while RSSEV (TBEV-FE subtype) remains classified as needing BSL-4 containment.

Select Agent TBEV-CE viruses are Select Agents requiring registration with CDC and/or USDA for possession, use, storage, and/or transfer. See [Appendix F](#) for additional information.

Transfer of Agent Importation of these agents may require CDC and/or USDA importation permits. Domestic transport of these agents may require a permit from USDA APHIS VS. A Department of Commerce (DoC) permit may be required for the export of these agents to another country. See [Appendix C](#) for additional information.

Vaccines Investigational vaccines for persons working with eastern equine encephalomyelitis virus (EEEV), Venezuelan equine encephalitis virus (VEEV), western equine encephalomyelitis virus (WEEV), and Rift Valley fever viruses (RVFV) may be available in limited quantities and administered on-site at the Special Immunization Program of USAMRIID, located at Ft. Detrick, Frederick, MD. These, and other vaccines that are investigational new drugs (IND), are administered under a cooperative agreement between the Special Immunization Program and the individual's requesting organization.

The use of these investigational vaccines for laboratory personnel should be considered if the vaccine is available. Initial studies have shown these vaccines to be effective in producing an appropriate immunologic response, and the adverse effects of vaccination are within acceptable parameters.^{7,8,9} The decision to recommend vaccines for laboratory personnel must be carefully considered and based on a risk assessment that includes a review of the characteristics of the agent and the disease, benefits vs. the risk of vaccination, experience of the laboratory personnel, laboratory procedures to be used with the agent, and contraindications for vaccination including the health status of the employee.

If the investigational vaccine is contraindicated or laboratory personnel refuse vaccination, the use of enhanced engineering controls, practices, or personal protective equipment may provide an alternative. Respiratory protection, such as use of a PAPR, is a best practice when using organisms with a well-established risk of aerosol infections in the laboratory, such as VEE viruses.

Any respiratory protection equipment must be provided in conjunction with an appropriately constituted respiratory protection program. Other methods of respiratory protection may be warranted based on an assessment of risk as defined in [Section II](#) of this manual. All personnel in a laboratory with the infectious agent

must use comparable personal protective equipment that meets or exceeds the requirements, even if they are not working with the organism. Sharps precautions as described in [Section IV](#) must be continually and strictly reinforced, regardless of whether investigational vaccines are used.

Enhanced BSL-3 Containment

HEPA filtration of the exhaust air is recommended for viruses handled at BSL-3 and listed in Table 5.

Situations may arise for which enhancements to BSL-3 practices and equipment are required; for example, when a BSL-3 laboratory performs diagnostic testing on specimens from patients with hemorrhagic fevers thought to be due to dengue or yellow fever viruses. When the origin of these specimens is Africa, the Middle East, or South America, such specimens might contain etiologic agents, such as arenaviruses, filoviruses, or other viruses that are usually manipulated in a BSL-4 laboratory. Examples of enhancements to BSL-3 laboratories include: 1) enhanced respiratory protection of personnel against aerosols; 2) HEPA filtration of exhaust air from the laboratory; and 3) personal body shower upon exit. Additional appropriate training is recommended for all staff, including animal care personnel.

Risk Group 4 Viruses with BSL-4 Containment Recommended

The recommendations for viruses assigned to BSL-4 containment are based on documented cases of severe and frequently fatal, naturally occurring human infections and aerosol-transmitted laboratory infections. SALS recommends that certain agents with a close antigenic or genetic relationship to agents assigned to BSL-4 also be provisionally handled at this level until sufficient laboratory data indicates that work with the agent may be assigned to a lower Biosafety Level.

Laboratory Safety and Containment Recommendations

The infectious agents may be present in blood, urine, respiratory and throat secretions, semen, and other fluids and tissues from human or animal hosts as well as in arthropods, rodents, and non-human primates (NHPs). Respiratory exposure to infectious aerosols, mucous membrane exposure to infectious droplets, and accidental parenteral inoculation are the primary hazards to laboratory or animal care personnel.^{10,11}

BSL-4 practices, containment equipment, and facilities are recommended for all activities using materials of human, animal, or arthropod origin that may be infected with one of the agents listed in this summary. Clinical specimens from persons suspected of being infected with one of the agents listed in this summary should be submitted to a laboratory with a BSL-4 facility.¹²

Dealing with Unknown Arboviruses The ACAV has published reports documenting laboratory workers who acquired arbovirus infections during the course of their duties.^{2,13} In the first such report, it was recognized that these laboratory infections typically occurred by unnatural routes such as percutaneous or aerosol exposure, that “lab-adapted” strains were still pathogenic for humans, and that as more laboratories worked with newly identified agents, the frequency of LAIs was increasing. Therefore, to assess the risk of these viruses and provide safety guidelines to those working with them, ACAV appointed SALS to evaluate the hazards of working with arboviruses in the laboratory setting.^{2,14,15}

The SALS committee made a series of recommendations, published in 1980, describing four levels of laboratory practices and containment guidelines that were progressively more restrictive. These levels were determined after widely-distributed surveys evaluated numerous criteria for each particular virus including: 1) past occurrence of LAIs correlated with facilities and practices used; 2) volume of work performed as a measure of potential exposure risk; 3) immune status of laboratory personnel; 4) incidence and severity of naturally-acquired infections in adults; and 5) incidence of disease in animals outside the United States (to assess import risk).

While these criteria are still important factors to consider in any risk assessment for manipulating arboviruses in the laboratory, it is important to note that there have been many modifications to personal laboratory practices (e.g., working in a BSC while wearing personal protective equipment in contrast to working with viruses on an open benchtop) and significant changes in laboratory equipment, facilities, and PPE (e.g., BSC, PAPR) available since the initial SALS evaluation. When dealing with a newly recognized or poorly characterized arbovirus, where there is insufficient previous experience to characterize the risk, investigators should consider using additional safety measures. Additionally, when working with field-collected mosquitoes that may contain arboviruses, additional protective measures should be considered, particularly with procedures that can generate aerosols. New methods allow the relationships between newly discovered viruses and other disease-causing arboviruses to be established with less work and less potential for exposure. One criterion for a newly identified arbovirus is a thorough description of how the virus will be handled and investigated. For example, experiments involving pure genetic analysis could be handled differently than those where the virus will be put into animals or arthropods.^{16,17} Therefore, in addition to those established by SALS, additional assessment criteria should be considered in the risk assessment.

Most of the identified arboviruses have recommended Biosafety Levels for routine handling; however, a number of those that are infrequently studied, newly identified, or have only single isolation events may not have been fully evaluated by SALS, ACAV, CDC, or the NIH. Thorough risk assessment is important for all

arboviral research and it is of particular importance for work involving unclassified viruses. Additionally, an individual risk assessment should consider the fact that not all strains of a particular virus exhibit the same degree of pathogenicity or transmissibility. A careful assessment by the laboratory director, institutional biosafety officer and safety committee, and outside experts, as necessary, functions to minimize the risk of human, animal, and environmental exposure while allowing research to progress.

Chimeric Viruses The ability to construct cDNA clones encoding a complete RNA viral genome has led to the generation of recombinant viruses containing a mixture of genes from two or more different viruses. Chimeric, full-length viruses and truncated replicons have been constructed from numerous alphaviruses and flaviviruses. For example, alphavirus replicons encoding foreign genes have been used widely as immunogens against bunyavirus, filovirus, arenavirus, and other antigens. These replicons have been safe and usually immunogenic in rodent hosts leading to their development as candidate human vaccines against several virus groups including retroviruses.¹⁸⁻²¹

Because chimeric viruses contain portions of multiple viruses, the IBC or equivalent resource, in conjunction with the biosafety officer and the researchers, must conduct a risk assessment that, in addition to standard criteria, includes specific elements that need to be considered before assigning appropriate Biosafety Levels and containment practices. These elements include: 1) the ability of the chimeric virus to replicate in cell culture and animal model systems in comparison with its parental strains;²² 2) altered virulence characteristics or attenuation compared with the parental viruses in animal models;²³ 3) virulence or attenuation patterns by intracranial routes using large doses for agents affecting the CNS;^{24,25} and 4) demonstration of lack of reversion to virulence or parental phenotype. Additionally, while variable pathogenicity occurs frequently with naturally identified strains, it is of particular note for strains that are modified in the laboratory. It may be tempting to assign Biosafety Levels to hybrid or chimeric strains based on the parental types but due to possible altered biohazard potential, a separate risk assessment needs to be completed, and an assignment to a different Biosafety Level may be justified.²⁶ A clear description of the strains involved should accompany any risk assessment.

Many patterns of attenuation have been observed with chimeric flaviviruses and alphaviruses using the criteria described above, and some of these chimeras have undergone testing as human vaccines.²⁷

Chimeric viruses may have some safety features not associated with parental viruses. For example, they are generated from genetically stable cDNA clones without the need for animal or cell culture passage. This minimizes the possibility of mutations that could alter virulence properties. Because some chimeric strains

incorporate genomic segments lacking gene regions or genetic elements critical for virulence, there may be a limited possibility of genetic changes that could generate strains exhibiting wild-type virulence.

Ongoing surveillance and laboratory studies suggest that many arboviruses continue to be a risk to human and animal populations. The attenuation of all chimeric strains should be verified using the most rigorous containment requirements of the parental strains. The local IBC, or equivalent resource, should evaluate containment recommendations for each chimeric virus on a case-by-case basis, using virulence data from an appropriate animal model. Additional guidance from the NIH Office of Science Policy may be necessary.

West Nile Virus (WNV)

This virus belongs to the family *Flaviviridae* and the genus *Flavivirus*, Japanese encephalitis virus antigenic complex. The complex currently includes Alfuy, Cacipacore, Japanese encephalitis, Koutango, Kunjin, Murray Valley encephalitis, St. Louis encephalitis, Rocio, Stratford, Usutu, West Nile, and Yaounde viruses. Flaviviruses share a common size (40–60nm), symmetry (enveloped, icosahedral nucleocapsid), nucleic acid (positive-sense, single-stranded RNA approximately 10,000–11,000 bases), and virus morphology. The virus was first isolated from a febrile, adult woman in the West Nile District of Uganda in 1937.²⁸ The ecology was characterized in Egypt in the 1950s; equine disease was first noted in Egypt and France in the early 1960s.^{29,30} It first appeared in North America in 1999 causing encephalitis in humans and horses.³¹ The virus has now been detected in Africa, Europe, the Middle East, west and central Asia, Oceania (subtype Kunjin virus), and North and South America.

WNV spread over the past 20 years throughout temperate regions of Europe and North America. As the ecological and epidemiological patterns of this virus in the new geographic regions evolved, WNV is now endemic throughout the U.S. and is one of the most extensively studied arboviruses in this country.

While WNV can cause serious neurologic disease, most people infected with WNV do not have symptoms. About one in five people who are infected develop a fever with other symptoms such as headache, body aches, joint pains, vomiting, diarrhea, or rash. About one out of 150 infected people develop a serious, sometimes fatal, illness affecting the central nervous system such as encephalitis (inflammation of the brain) or meningitis (inflammation of the membranes that surround the brain and spinal cord). Symptoms of severe illness include high fever, headache, neck stiffness, stupor, disorientation, coma, tremors, convulsions, muscle weakness, vision loss, numbness, and paralysis. There are no vaccines to prevent WNV in people; treatment is supportive.

Occupational Infections

LAI with WNV have been reported in the literature. SALS reported 15 human infections from laboratory accidents in 1980.² One of these infections was attributed to aerosol exposure. However, with the development of improved laboratory and PPE equipment, only three LAIs (due to parenteral inoculations during work with sharps) have been published in the past two decades.^{32,33}

Natural Modes of Infection

In the U.S., infected mosquitoes, primarily members of the *Culex* genus, transmit WNV. Virus amplification occurs during periods of adult mosquito blood-feeding by continuous transmission between mosquito vectors and bird reservoir hosts. Humans, horses, and most other mammals are not known to develop infectious viremias very often, and thus, are probably “dead-end” or incidental hosts.

Laboratory Safety and Containment Recommendations

WNV may be present in blood, serum, tissues, and CSF of infected humans, birds, mammals, and reptiles. The virus has been found in oral fluids and feces of birds. Parenteral inoculation with contaminated materials poses the greatest hazard; contact exposure of broken skin is a possible risk. Sharps precautions should be strictly adhered to when handling potentially infectious materials. Workers performing necropsies on infected animals or exposed to feces of infected birds may be at higher risk of infection.

Given the significant number of laboratories working with WNV (with only three parenteral LAIs) and the nearly complete endemicity across the U.S., BSL-2 practices, containment equipment, and facilities are now recommended for all manipulations of WNV. BSL-2 practices and facilities are similarly recommended for the closely related and also endemic St. Louis encephalitis virus. As always, each laboratory should perform a risk assessment to determine if the procedures being conducted might warrant additional containment measures. For example, if working with extremely high titers of virus or aerosol-generating procedures, BSL-3 containment might be considered. For laboratories seeking to move existing work with WNV from BSL-3 laboratories to BSL-2, a thorough assessment should be made to assess the possible risk from contamination of samples with other agents needing BSL-3 containment.

Special Issues

Transfer of Agent Importation of this agent may require CDC and/or APHIS importation permits. Domestic transport of this agent may require a permit from USDA APHIS VS. A DoC permit may be required for the export of this agent to another country. See [Appendix C](#) for additional information.

Eastern Equine Encephalitis Virus (EEEV), Venezuelan Equine Encephalitis Virus (VEEV), and Western Equine Encephalitis Virus (WEEV)

VEEV, EEEV, and WEEV are members of the genus *Alphavirus* in the family *Togaviridae*. They are small, enveloped viruses with a genome consisting of a single strand of positive-sense RNA. All three viruses can cause encephalitis often accompanied by long-term neurological sequelae. The incubation period ranges from one to 10 days, and the duration of acute illness is typically days to weeks depending upon severity of the illness. Although not the natural route of transmission, the viruses are highly infectious by the aerosol route, and LAIs have been documented.³⁴ Of note, strains of EEEV from South America are now designated as Madariaga virus (MADV) and are no longer considered EEEV viruses.³⁵ Madariaga virus strains, while still within the EEE antigenic complex, are genetically and ecologically distinct from North American strains of EEEV. They typically do not cause large epizootics, and their capacity to cause human illness is not well-characterized.

The encephalitic alphaviruses are all capable of causing lethal encephalitis in humans and horses; however, the patterns of disease, disease severity, and incidence vary greatly. Most reported cases represent severe forms of disease as the majority of infections are either mild, flu-like illness, or asymptomatic. WEEV is currently the rarest, with no human infections detected since 1988, and fewer than 700 total cases reported in the United States since the 1960s. Young children (<12 months) are the most susceptible to severe disease with an overall mortality rate estimated at about 4%. EEEV is also rare in the United States with an average of seven neurological cases each year. However, encephalitic cases of EEEV infection can have a mortality rate estimated at 30–70% and survivors often experience severe permanent neurological sequelae. VEEV mortality rates are typically around 1% and severe cases are typically in children. One of the largest VEEV outbreaks occurred in Columbia in 1995 and affected approximately 75,000 individuals. Of these, 3,000 developed neurological manifestations with a total of approximately 300 deaths. There are no licensed vaccines or therapeutics available.

Occupational Infections

These alphaviruses, especially VEEV, are infectious by aerosol in laboratory studies and more than 160 EEEV, VEEV, or WEEV LAIs have been documented. Many infections were due to procedures involving high virus concentrations and aerosol-generating activities such as centrifugation and mouth pipetting. Procedures involving animals (e.g., infection of newly hatched chicks with EEEV and WEEV) and mosquitoes are also particularly hazardous.

Natural Modes of Infection

Alphaviruses are zoonoses maintained and amplified in natural transmission cycles involving a variety of mosquito species and either small rodents or birds. Humans and equines are accidental hosts with naturally acquired alphavirus infections resulting from the bites of infected mosquitoes.

EEEV occurs in focal locations along the eastern seaboard, the Gulf Coast, and some inland Midwestern locations of the United States, in Canada, and some Caribbean Islands; the related MADV occurs in Central and South America.^{35,36} Small outbreaks of human disease have occurred in the United States, the Dominican Republic, Cuba, and Jamaica. In the United States, equine epizootics are common occurrences during the summer in coastal regions bordering the Atlantic and Gulf of Mexico, in other eastern and Midwestern states, and as far north as Quebec, Ontario, and Alberta in Canada.

In Central and South America, focal outbreaks due to VEE virus occur periodically with rare large regional epizootics involving thousands of equine cases and deaths in predominantly rural settings. These epizootic/epidemic viruses are theorized to emerge periodically from mutations occurring in the continuously circulating enzootic VEE viruses in northern South America. The classical epizootic varieties of the virus are not present in the United States. An enzootic subtype, Everglades virus (VEE antigenic complex subtype II virus), exists naturally in southern Florida; endemic foci of Bijou Bridge virus (VEE antigenic complex subtype III-B virus), have been described in the western United States.³⁷

WEEV is found mainly in western parts of the United States and Canada. Sporadic infections also occur in Central and South America.

Laboratory Safety and Containment Recommendations

Alphaviruses may be present in blood, CSF, other tissues (e.g., brain), or throat washings. The primary laboratory hazards are parenteral inoculation, contact of the virus with broken skin or mucous membranes, bites of infected animals or arthropods, or aerosol inhalation.

Diagnostic and research activities involving clinical material, infectious cultures, and infected animals or arthropods should be performed with BSL-3 practices, containment equipment, and facilities. Due to the high risk of aerosol infection, respiratory protection is a best practice for non-immune personnel. Animal work with VEEV, EEEV, and WEEV should be performed under ABSL-3 conditions. HEPA filtration is required on the exhaust system of laboratory and animal facilities using VEEV.

Special Issues

Vaccines Two strains of VEEV (TC-83 and V3526) are highly attenuated in vertebrate studies and are excluded from Select Agent regulations. Because of the low level of pathogenicity, these strains may be safely handled under BSL-2 conditions without vaccination or additional personal protective equipment (e.g., respiratory protection).

Investigational vaccine protocols have been developed to immunize at-risk laboratory or field personnel against these alphaviruses; however, the vaccines are available only on a limited basis and may be contraindicated for some personnel. Therefore, additional personal protective equipment may be warranted if vaccination can't be administered. For personnel who have no neutralizing antibody titer (from previous vaccination or natural infection), respiratory protection should be considered for all procedures.

Select Agent Epizootic (equine amplification-competent) subtype strains of VEEV (subtypes IAB and IC) and EEEV (but not MADV) are Select Agents requiring registration with CDC and/or APHIS for possession, use, storage, and/or transfer. See [Appendix F](#) for additional information.

Transfer of Agent Importation of this agent may require CDC and/or APHIS importation permits. Domestic transport of this agent may require a permit from USDA APHIS VS. A Department of Commerce (DoC) permit may be required for the export of this agent to another country. See [Appendix C](#) for additional information.

Rift Valley Fever Virus (RVFV)

RVFV was first isolated in Kenya in 1936 and subsequently shown to be endemically present in almost all areas of sub-Saharan Africa.³⁸ In periods of heavy rainfall, large epizootics occur involving primarily sheep, cattle, and human disease, although many other species are infected. The primordial vertebrate reservoir is unknown, but the introduction of large herds of highly susceptible domestic breeds in the last few decades has provided a substrate for massive virus amplification. The virus has been introduced into Egypt, Saudi Arabia, and Yemen and caused epizootics and epidemics in those countries. The largest of these was from 1977 to 1979 in Egypt with many thousands of human cases and 610 reported deaths.³⁹

Most human infections are symptomatic and the most common syndrome consists of fever, myalgia, malaise, anorexia, and other non-specific symptoms. Recovery within one to two weeks is usual, but hemorrhagic fever, encephalitis, or retinitis also occur. Hemorrhagic fever develops as the primary illness progresses and is characterized by disseminated intravascular coagulation and hepatitis. Perhaps 2% of cases will develop this complication and the mortality

is high. Encephalitis follows apparent recovery in <1% of cases and results in a substantial mortality and sequelae. Retinal vasculitis occurs in convalescence of a substantial, but not precisely known, proportion of cases. The retinal lesions are often macular and permanent, leading to substantial loss of visual acuity.

Infected sheep and cattle suffer a mortality rate of 10–35%, and spontaneous abortion occurs virtually in all pregnant females. Other animals studied have lower viremia and lesser mortality but may abort. This virus is a World Organization for Animal Health (OIE) List A disease and triggers export sanctions.

Occupational Infections

The potential for infection of humans by routes other than arthropod transmission was first recognized in veterinarians performing necropsies. Subsequently, it became apparent that contact with infected animal tissues and infectious aerosols were dangerous; many infections were documented in herders, slaughterhouse workers, and veterinarians. Most of these infections resulted from exposure to blood and other tissues including aborted fetal tissues of sick animals.

There have been 47 reported laboratory infections; before modern containment and vaccination became available, virtually every laboratory that began work with the virus suffered infections suggestive of aerosol transmission.^{40,41}

Natural Modes of Infection

Field studies show RVFV to be transmitted predominantly by mosquitoes; although, other arthropods may be infected and transmit. Mechanical transmission also has been documented in the laboratory. Floodwater *Aedes* species are the primary vector and transovarial transmission is an important part of the maintenance cycle.⁴² However, many different mosquito species are implicated in horizontal transmission in field studies, and laboratory studies have shown a large number of mosquito species worldwide to be competent vectors, including North American mosquitoes.

It is currently believed that the virus passes dry seasons in the ova of flood-water *Aedes* mosquitoes. Rain allows infectious mosquitoes to emerge and feed on vertebrates. Several mosquito species can be responsible for horizontal spread, particularly in epizootic/epidemic situations. The vertebrate amplifiers are usually sheep and cattle, with two caveats: 1) a native African vertebrate amplifier is thought to exist but is yet to be defined, and 2) very high viremias in humans are thought to play some role in viral amplifications.⁴³

Transmission of disease occurs between infected animals but is of low efficiency; virus titers in throat swabs are low. Nosocomial infection rarely, if ever, occurs. There are no examples of latency with RVFV, although virus may be isolated from lymphoid organs of mice and sheep for four to six weeks post-infection.

Laboratory Safety and Containment Recommendations

Concentrations of RVFV in blood and tissues of sick animals are often very high. Placenta, amniotic fluid, and fetuses from aborted domestic animals are highly infectious. Large numbers of infectious virus particles also are generated in cell cultures and laboratory animals.

BSL-3 practices, containment equipment, and facilities are recommended for processing human or animal material in endemic zones or in non-endemic areas in emergency circumstances. Particular care should be given to stringent aerosol containment practices, autoclaving waste, decontamination of work areas, and control of egress of material from the laboratory. Other cultures, cells, or similar biological material that could potentially harbor RVFV should not be used in an RVFV laboratory and subsequently removed.

Diagnostic or research studies outside endemic areas should be performed in a BSL-3 laboratory. Personnel also must have respiratory protection (e.g., PAPR) or be vaccinated for RVFV. In addition, APHIS may require full ABSL-3Ag containment for research conducted in non-endemic areas using loose-housed animals. See [Appendix D](#) for additional information.

Special Issues

Vaccines Two apparently effective vaccines have been developed by the Department of Defense (DOD) and have been used in volunteers, laboratory staff, and fieldworkers under investigational protocols, but neither vaccine is available at this time.

Select Agent RVFV is a Select Agent requiring registration with CDC and/or APHIS for possession, use, storage and/or transfer. See [Appendix F](#) for additional information.

The live-attenuated MP-12 vaccine strain and the Δ NSs- Δ NSm-ZH501 strain are excluded from the Select Agent regulations. In general, BSL-2 containment is recommended for working with these strains.

APHIS may require ABSL-3 enhanced, ABSL-3, or ABSL-3Ag facilities and practices for working with RVFV in the United States; see [Appendix D](#) for additional information. Investigators should contact APHIS for further guidance before initiating research.

Transfer of Agent Importation of this agent may require CDC and/or APHIS importation permits. Domestic transport of this agent may require a permit from USDA APHIS VS. A Department of Commerce (DoC) permit may be required for the export of this agent to another country. See [Appendix C](#) for additional information.

Table 2. Explanation of Symbols Used in Tables 3 and 4 to Define Basis for Assignment of Viruses to Biosafety Levels

Symbol	Definition
S	Results of SALS survey and information from the Catalog. ¹
IE	Insufficient experience with virus in laboratory facilities with low biocontainment.
A	Additional Criteria (A1–A8)
A1	Disease in sheep, cattle, or horses.
A2	Fatal human laboratory infection—probably aerosol.
A3	Extensive laboratory experience and mild nature of aerosol laboratory infections justify BSL-2.
A4	Placed in BSL-4 based on the close antigenic relationship with a known agent handled at BSL-4 plus insufficient experience.
A5	Arenaviruses handled at BSL-2 are not known to cause serious acute disease in humans and are not acutely pathogenic for laboratory animals including primates. It is strongly recommended that work with high concentrations of these arenaviruses be done at BSL-3.
A6	Level assigned to prototype or wild-type virus. A lower level may be recommended for variants with well-defined reduced virulence characteristics.
A7	Placed at this Biosafety Level based on close antigenic or genetic relationship to other viruses in a group of three or more viruses, all of which are classified at this level.
A8	Hantaviruses handled at BSL-2 are not known to cause laboratory infections, overt disease in humans, or severe disease in experimental primates. Because of antigenic and biologic relationships to highly pathogenic hantaviruses and the likelihood that experimentally infected rodents may shed large amounts of virus, it is recommended that work with high concentrations of virus or experimentally infected rodents be conducted at BSL-3.

Table 3. Alphabetic Listing of Arboviruses and Hemorrhagic Fever Viruses*

Virus Name	Acronym	Family	Genus	Recommended BSL	Basis of Rating	Antigenic Group
Abadina	ABAV	<i>Reoviridae</i>	<i>Orbivirus</i>	2	A7	N/A
Above Maiden	ABMV	<i>Reoviridae</i>	<i>Orbivirus</i>	2	A7	N/A
Abras	ABRV	<i>Peribunyaviridae</i>	<i>Orthobunyavirus</i>	2	A7	Patois
Absettarov	ABSV	<i>Flaviviridae</i>	<i>Flavivirus</i>	4	A4	Tick-borne Encephalitis—CE subtype
Abu Hammad	AHV	<i>Nairoviridae</i>	<i>Orthonairovirus</i>	2	S	Dera Ghazi Khan
Abu Mina	ABMV	<i>Nairoviridae</i>	<i>Orthonairovirus</i>	2	A7	N/A
Acado	ACDV	<i>Reoviridae</i>	<i>Orbivirus</i>	2	S	Corriparta
Acara	ACAV	<i>Peribunyaviridae</i>	<i>Orthobunyavirus</i>	2	S	Capim
Achiote	ACHOV	<i>Peribunyaviridae</i>	<i>Orthobunyavirus</i>	2	A7	California
Adana	ADAV	<i>Phenuiviridae</i>	<i>Phlebovirus</i>	2	A7	Salehabad
Adelaide River	ARV	<i>Rhabdoviridae</i>	<i>Ephemerovirus</i>	2	IE	Bovine Ephemeral Fever
Adria	ADRV	<i>Phenuiviridae</i>	<i>Phlebovirus</i>	2	A7	N/A
African horse sickness	AHSV	<i>Reoviridae</i>	<i>Orbivirus</i>	3 ^b	A1	African Horse Sickness
African swine fever	ASFV	<i>Asfarviridae</i>	<i>Asfivirus</i>	3 ^b	IE	Asfivirus
Aguate	AGUV	<i>Phenuiviridae</i>	<i>Phlebovirus</i>	2	S	Phlebotomus Fever
Aino	AINOV	<i>Peribunyaviridae</i>	<i>Orthobunyavirus</i>	2	S	Simbu
Akabane	AKAV	<i>Peribunyaviridae</i>	<i>Orthobunyavirus</i>	3 ^b	S	Simbu
Alajuela	ALJV	<i>Peribunyaviridae</i>	<i>Orthobunyavirus</i>	2	A7	N/A
Alcube	N/A	<i>Phenuiviridae</i>	<i>Phlebovirus</i>	2	A7	N/A
Alenquer	ALEV	<i>Phenuiviridae</i>	<i>Phlebovirus</i>	2	IE	Phlebotomus Fever
Alfuy	ALFV	<i>Flaviviridae</i>	<i>Flavivirus</i>	2	S	N/A
Alkhurma	AHFV	<i>Flaviviridae</i>	<i>Flavivirus</i>	4	A4	Tick-borne Encephalitis—CE subtype
Allpahuayo	ALLPV	<i>Arenaviridae</i>	<i>Mammarenavirus</i>	3	IE	Tacaribe
Almeirim	ALMV	<i>Reoviridae</i>	<i>Orbivirus</i>	2	IE	Changuinola
Almpiwar	ALMV	<i>Rhabdoviridae</i>	<i>Sripuvirus</i>	2	S	N/A
Altamira	ALTV	<i>Reoviridae</i>	<i>Orbivirus</i>	2	IE	Changuinola
Amapari	AMAV	<i>Arenaviridae</i>	<i>Mammarenavirus</i>	2	A5	Tacaribe
Ambe	AMBEV	<i>Phenuiviridae</i>	<i>Phlebovirus</i>	2	IE	N/A
Amga	MGAV	<i>Hantaviridae</i>	<i>Orthohantavirus</i>	3 ^a	A7	N/A
Amur/Soochong	ASV	<i>Hantaviridae</i>	<i>Orthohantavirus</i>	3 ^a	A7	N/A
Anadyr	ANADV	<i>Peribunyaviridae</i>	<i>Orthobunyavirus</i>	2	A7	N/A
Anajatuba	ANJV	<i>Hantaviridae</i>	<i>Orthohantavirus</i>	3 ^a	A7	N/A
Ananindeua	ANUV	<i>Peribunyaviridae</i>	<i>Orthobunyavirus</i>	2	A7	Guama
Andasibe	ANDV	<i>Reoviridae</i>	<i>Orbivirus</i>	2	A7	N/A
Andes	ANDV	<i>Hantaviridae</i>	<i>Orthohantavirus</i>	3 ^a	IE	Hantaan
Anhanga	ANHV	<i>Phenuiviridae</i>	<i>Phlebovirus</i>	2	S	Phlebotomus Fever
Anhembí	AMBV	<i>Peribunyaviridae</i>	<i>Orthobunyavirus</i>	2	S	Bunyamwera
Anopheles A	ANAV	<i>Peribunyaviridae</i>	<i>Orthobunyavirus</i>	2	S	Anopheles A
Anopheles B	ANBV	<i>Peribunyaviridae</i>	<i>Orthobunyavirus</i>	2	S	Anopheles B
Antequera	ANTV	<i>Unclassified Bunyavirales</i>		2	IE	Antequera
Apeú	APEUV	<i>Peribunyaviridae</i>	<i>Orthobunyavirus</i>	2	S	N/A
Apoi	APOIV	<i>Flaviviridae</i>	<i>Flavivirus</i>	2	S	N/A
Araguari	ARAV	<i>Orthomyxoviridae</i>	Unassigned	3	IE	N/A

Continued on next page ►

Virus Name	Acronym	Family	Genus	Recommended BSL	Basis of Rating	Antigenic Group
Aransas Bay	ABV	<i>Orthomyxoviridae</i>	<i>Thogotovirus</i>	2	IE	Upolu
Araraquara	ARQV	<i>Hantaviridae</i>	<i>Orthohantavirus</i>	3*	A7	N/A
Araucaria	ARAUV	<i>Hantaviridae</i>	<i>Orthohantavirus</i>	3*	A7	N/A
Arbia	ARBV	<i>Phenuiviridae</i>	<i>Phlebovirus</i>	2	IE	Phlebotomus Fever
Arboledas	ADSV	<i>Phenuiviridae</i>	<i>Phlebovirus</i>	2	A7	Phlebotomus Fever
Arbroath	ABRV	<i>Reoviridae</i>	<i>Orbivirus</i>	2	A7	N/A
Arde	ARIV	<i>Unclassified virus</i>		2	S	N/A
Ariqemes	ARQV	<i>Phenuiviridae</i>	<i>Phlebovirus</i>	2	A7	Phlebotomus Fever
Arkonam	ARKV	<i>Reoviridae</i>	<i>Orbivirus</i>	2	S	N/A
Armero	ARMV	<i>Phenuiviridae</i>	<i>Phlebovirus</i>	2	A7	Phlebotomus Fever
Aroa	AROAV	<i>Flaviviridae</i>	<i>Flavivirus</i>	2	S	N/A
Arrabida	ARRV	<i>Phenuiviridae</i>	<i>Phlebovirus</i>	2	A7	N/A
Artashat	ARTSV	<i>Nairoviridae</i>	<i>Orthonairovirus</i>	3	IE	N/A
Aruac	ARUV	<i>Rhabdoviridae</i>	Unassigned	2	S	N/A
Arumateua	ARMTV	<i>Peribunyaviridae</i>	<i>Orthobunyavirus</i>	2	A7	N/A
Arumowot	AMTV	<i>Phenuiviridae</i>	<i>Phlebovirus</i>	2	S	Phlebotomus Fever
Asama	ASAV	<i>Hantaviridae</i>	<i>Orthohantavirus</i>	3*	A7	N/A
Asikkala	ASIV	<i>Hantaviridae</i>	<i>Orthohantavirus</i>	3*	A7	N/A
Aura	AURAV	<i>Togaviridae</i>	<i>Alphavirus</i>	2	S	Western Equine Encephalitis
Avalon	AVAV	<i>Nairoviridae</i>	<i>Orthonairovirus</i>	2	S	Sakhalin
Babahoyo	BABV	<i>Peribunyaviridae</i>	<i>Orthobunyavirus</i>	2	A7	Patois
Babanki	BBKV	<i>Togaviridae</i>	<i>Alphavirus</i>	2	A7	Western Equine Encephalitis
Bagaza	BAGV	<i>Flaviviridae</i>	<i>Flavivirus</i>	2	S	N/A
Bahig	BAHV	<i>Peribunyaviridae</i>	<i>Orthobunyavirus</i>	2	S	Tete
Bakau	BAKV	<i>Peribunyaviridae</i>	<i>Orthobunyavirus</i>	2	S	Bakau
Bakel	BAKV	<i>Nairoviridae</i>	<i>Orthonairovirus</i>	2	A7	N/A
Baku	BAKUV	<i>Reoviridae</i>	<i>Orbivirus</i>	2	S	Kemerovo
Balkan	BALKV	<i>Phenuiviridae</i>	<i>Phlebovirus</i>	2	A7	N/A
Bandia	BDV	<i>Nairoviridae</i>	<i>Orthonairovirus</i>	2	S	Qalyub
Bangoran	BGNV	<i>Rhabdoviridae</i>	Unassigned	2	S	N/A
Bangui	BGIV	<i>Unclassified Bunyavirales</i>	N/A	2	S	N/A
Banna	BAV	<i>Reoviridae</i>	<i>Seadornavirus</i>	3	IE	N/A
Banzi	BANV	<i>Flaviviridae</i>	<i>Flavivirus</i>	2	S	N/A
Barmah Forest	BFV	<i>Togaviridae</i>	<i>Alphavirus</i>	2	A7	Barmah Forest
Barranqueras	BQSV	<i>Unclassified Bunyavirales</i>	N/A	2	IE	Antequera
Barur	BARV	<i>Rhabdoviridae</i>	<i>Ledantavirus</i>	2	S	Kern Canyon
Batai	BATV	<i>Peribunyaviridae</i>	<i>Orthobunyavirus</i>	2	S	Bunyamwera
Batama	BMAV	<i>Peribunyaviridae</i>	<i>Orthobunyavirus</i>	2	A7	Tete
Batken	BKNV	<i>Orthomyxoviridae</i>	<i>Thogotovirus</i>	2	IE	N/A
Batu Cave	BCV	<i>Flaviviridae</i>	<i>Flavivirus</i>	2	A7	N/A
Bauline	BAUV	<i>Reoviridae</i>	<i>Orbivirus</i>	2	S	Kemerovo
Bayou	BAYV	<i>Hantaviridae</i>	<i>Orthohantavirus</i>	3*	A7	N/A
BeAr 328208	BAV	<i>Peribunyaviridae</i>	<i>Orthobunyavirus</i>	2	A7	N/A
Bear Canyon	BCNV	<i>Arenaviridae</i>	<i>Mammarenavirus</i>	3	A7	N/A

Continued on next page ►

Virus Name	Acronym	Family	Genus	Recommended BSL	Basis of Rating	Antigenic Group
Beatrice Hill	BHV	<i>Rhabdoviridae</i>	<i>Tibrovirus</i>	2	IE	N/A
Beaumont	BEAUV	<i>Rhabdoviridae</i>	Unassigned	2	A7	N/A
Bebaru	BEBV	<i>Togaviridae</i>	<i>Alphavirus</i>	2	S	Semliki Forest
Belem	BLMV	<i>Unclassified Bunyvirales</i>	N/A	2	IE	N/A
Belmont	BELV	<i>Unclassified Bunyvirales</i>	N/A	2	S	N/A
Belterra	BELTV	<i>Phenuiviridae</i>	<i>Phlebovirus</i>	2	A7	Phlebotomus Fever
Benevides	BENV	<i>Peribunyaviridae</i>	<i>Orthobunyavirus</i>	2	A7	Capim
Benfica	BNFV	<i>Peribunyaviridae</i>	<i>Orthobunyavirus</i>	2	A7	Capim
Bermejo	BMJV	<i>Hantaviridae</i>	<i>Orthohantavirus</i>	3 ^a	IE	Hantaaan
Berrimah	BRMV	<i>Rhabdoviridae</i>	<i>Ephemerovirus</i>	2	IE	Bovine Ephemeral Fever
Bertioga	BERV	<i>Peribunyaviridae</i>	<i>Orthobunyavirus</i>	2	S	Guama
Bhanja	BHAV	<i>Phenuiviridae</i>	<i>Phlebovirus</i>	3	S	Bhanja
Big Brushy Tank	BBTV	<i>Arenaviridae</i>	<i>Mammarenavirus</i>	3	IE	N/A
Big Cypress	BCPOV	<i>Reoviridae</i>	<i>Orbivirus</i>	2	A7	N/A
Bimbo	BBOV	<i>Rhabdoviridae</i>	Unassigned	2	IE	N/A
Bimiti	BIMV	<i>Peribunyaviridae</i>	<i>Orthobunyavirus</i>	2	S	Guama
Birao	BIRV	<i>Peribunyaviridae</i>	<i>Orthobunyavirus</i>	2	S	Bunyamwera
Bivens Arm	BAV	<i>Rhabdoviridae</i>	<i>Tibrovirus</i>	2	IE	N/A
Black Creek Canal	BCCV	<i>Hantaviridae</i>	<i>Orthohantavirus</i>	3 ^a	A7	N/A
Bloodland Lake	BLLV	<i>Hantaviridae</i>	<i>Orthohantavirus</i>	2 ^a	A8	N/A
Blue River	BRV	<i>Hantaviridae</i>	<i>Orthohantavirus</i>	3 ^a	A7	N/A
Bluetongue (exotic serotypes)	BTV	<i>Reoviridae</i>	<i>Orbivirus</i>	3 ^b	S	Bluetongue
Bluetongue (non-exotic)	BTV	<i>Reoviridae</i>	<i>Orbivirus</i>	2 ^b	S	Bluetongue
Bobaya	BOBV	<i>Unclassified Bunyvirales</i>	N/A	2	IE	N/A
Bobia	BIAV	<i>Peribunyaviridae</i>	<i>Orthobunyavirus</i>	2	IE	Olifantsvlei
Boracéia	BORV	<i>Peribunyaviridae</i>	<i>Orthobunyavirus</i>	2	S	Anopheles B
Botambi	BOTV	<i>Peribunyaviridae</i>	<i>Orthobunyavirus</i>	2	S	Olifantsvlei
Boteke	BTkV	<i>Rhabdoviridae</i>	<i>Vesiculovirus</i>	2	S	Vesicular Stomatitis
Bouboui	BOUV	<i>Flaviviridae</i>	<i>Flavivirus</i>	2	S	Bouboui
Bourbon	BRBV	<i>Orthomyxoviridae</i>	<i>Thogotovirus</i>	2	A7	N/A
Bovine ephemeral fever	BEFV	<i>Rhabdoviridae</i>	<i>Ephemerovirus</i>	3	A1	Bovine Ephemeral Fever
Bowe	BOWV	<i>Hantaviridae</i>	<i>Orthohantavirus</i>	3 ^a	A7	N/A
Bozo	BOZOV	<i>Peribunyaviridae</i>	<i>Orthobunyavirus</i>	2	A7	Bunyamwera
Brazoran		<i>Peribunyaviridae</i>	Unassigned	2	A7	N/A
Breu Branco	BRBV	<i>Reoviridae</i>	<i>Orbivirus</i>	2	A7	N/A
Broadhaven	BRDV	<i>Reoviridae</i>	<i>Orbivirus</i>	2	A7	N/A
Bruconha	BRUV	<i>Peribunyaviridae</i>	<i>Orthobunyavirus</i>	2	A7	N/A
Bruges	BRGV	<i>Hantaviridae</i>	<i>Orthohantavirus</i>	3 ^a	A7	N/A
Buenaventura	BUEV	<i>Phenuiviridae</i>	<i>Phlebovirus</i>	2	IE	Phlebotomous Fever
Buggy Creek		<i>Togaviridae</i>	<i>Alphavirus</i>	2	A7	Western Equine Encephalitis
Bujaru	BUJV	<i>Phenuiviridae</i>	<i>Phlebovirus</i>	2	S	N/A
Bukalasa bat	BBV	<i>Flaviviridae</i>	<i>Flavivirus</i>	2	A7	N/A
Bundibugyo	BDBV	<i>Filoviridae</i>	<i>Ebolavirus</i>	4	A4	Ebola

Continued on next page ►

Virus Name	Acronym	Family	Genus	Recommended BSL	Basis of Rating	Antigenic Group
Bunyamwera	BUNV	<i>Peribunyaviridae</i>	<i>Orthobunyavirus</i>	2	S	Bunyamwera
Bunyip Creek	BCV	<i>Reoviridae</i>	<i>Orbivirus</i>	2	S	N/A
Burana	BURV	<i>Nairoviridae</i>	<i>Orthonairovirus</i>	2	A7	N/A
Burg El Arab	BEAV	<i>Unclassified Bunyavirales</i>	N/A	2	S	N/A
Bushbush	BSBV	<i>Peribunyaviridae</i>	<i>Orthobunyavirus</i>	2	S	N/A
Bussuquara	BSQV	<i>Flaviviridae</i>	<i>Flavivirus</i>	2	S	N/A
Buttonwillow	BUTV	<i>Peribunyaviridae</i>	<i>Orthobunyavirus</i>	2	S	N/A
Bwamba	BWAV	<i>Peribunyaviridae</i>	<i>Orthobunyavirus</i>	2	S	N/A
Cabassou	CABV	<i>Togaviridae</i>	<i>Alphavirus</i>	3	IE	Venezuelan Equine Encephalitis
Cacao	CACV	<i>Phenuiviridae</i>	<i>Phlebovirus</i>	2	S	N/A
Cache Valley	CVV	<i>Peribunyaviridae</i>	<i>Orthobunyavirus</i>	2	S	N/A
Cachoeira Portiera	CPOV	<i>Peribunyaviridae</i>	<i>Orthobunyavirus</i>	2	A7	N/A
Cacipacoré	CPCV	<i>Flaviviridae</i>	<i>Flavivirus</i>	2	IE	N/A
Caimito	CAIV	<i>Phenuiviridae</i>	<i>Phlebovirus</i>	2	S	N/A
Calchaqui	CQIV	<i>Peribunyaviridae</i>	Unassigned	2	A7	Gamboia
California encephalitis	CEV	<i>Peribunyaviridae</i>	<i>Orthobunyavirus</i>	2	S	California
Calovo	CVOV	<i>Peribunyaviridae</i>	<i>Orthobunyavirus</i>	2	S	N/A
Campana	CMAV	<i>Phenuiviridae</i>	<i>Phlebovirus</i>	2	A7	Punta Toro
Cananeia	CNAV	<i>Peribunyaviridae</i>	<i>Orthobunyavirus</i>	2	IE	N/A
Candiru	CDUV	<i>Phenuiviridae</i>	<i>Phlebovirus</i>	2	S	Candiru
Caninde	CANV	<i>Reoviridae</i>	<i>Orbivirus</i>	2	IE	Changuinola
Cano Delgadito	CADV	<i>Hantaviridae</i>	<i>Orthohantavirus</i>	3*	IE	Hantaan
Cao Bang	CBNV	<i>Hantaviridae</i>	<i>Orthohantavirus</i>	3*	A7	N/A
Cape Wrath	CWV	<i>Reoviridae</i>	<i>Orbivirus</i>	2	S	Kemerovo
Capim	CAPV	<i>Peribunyaviridae</i>	<i>Orthobunyavirus</i>	2	S	Capim
Capira	CAPV	<i>Phenuiviridae</i>	<i>Phlebovirus</i>	2	A7	Punta Toro
Caraipé	CRPV	<i>Peribunyaviridae</i>	<i>Orthobunyavirus</i>	2	A7	N/A
Carajás	CRJV	<i>Rhabdoviridae</i>	<i>Vesiculovirus</i>	2	A7	Vesicular Stomatitis
Caraparú	CARV	<i>Peribunyaviridae</i>	<i>Orthobunyavirus</i>	2	S	N/A
Carey Island	CIV	<i>Flaviviridae</i>	<i>Flavivirus</i>	2	S	N/A
Caspiy	CASV	<i>Nairoviridae</i>	<i>Orthonairovirus</i>	2	A7	N/A
Castelo dos Sonhos	CASV	<i>Hantaviridae</i>	<i>Orthohantavirus</i>	3*	IE	N/A
Cat Que	CQV	<i>Peribunyaviridae</i>	<i>Orthobunyavirus</i>	2	A7	N/A
Catarina	CTNV	<i>Arenaviridae</i>	<i>Mammarenavirus</i>	3	IE	N/A
Catú	CATUV	<i>Peribunyaviridae</i>	<i>Orthobunyavirus</i>	2	S	Guama
Chaco	CHOV	<i>Rhabdoviridae</i>	<i>Sripuvirus</i>	2	S	Timbo
Chagres	CHGV	<i>Phenuiviridae</i>	<i>Phlebovirus</i>	2	S	Phlebotomus Fever
Chandipura	CHPV	<i>Rhabdoviridae</i>	<i>Vesiculovirus</i>	2	S	Vesicular Stomatitis
Changuinola	CGLV	<i>Reoviridae</i>	<i>Orbivirus</i>	2	S	Changuinola
Chapare	CHAPV	<i>Arenaviridae</i>	<i>Mammarenavirus</i>	4	A4	N/A
Charleville	CHVV	<i>Rhabdoviridae</i>	Unassigned	2	S	Rab
Chenuda	CNUV	<i>Reoviridae</i>	<i>Orbivirus</i>	2	S	Kemerovo
Chikungunya	CHIKV	<i>Togaviridae</i>	<i>Alphavirus</i>	3	S	Semliki Forest
Chilibre	CHIV	<i>Phenuiviridae</i>	<i>Phlebovirus</i>	2	S	Phlebotomus Fever
Chim	CHIMV	<i>Nairoviridae</i>	<i>Orthonairovirus</i>	2	IE	N/A

Continued on next page ►

Virus Name	Acronym	Family	Genus	Recommended BSL	Basis of Rating	Antigenic Group
Chizé	CHZV	<i>Phenuiviridae</i>	<i>Phlebovirus</i>	2	A7	N/A
Chobar Gorge	CGV	<i>Reoviridae</i>	<i>Orbivirus</i>	2	S	Chobar Gorge
Choclo	CHOV	<i>Hantavirus</i>	<i>Orthohantavirus</i>	3 ^a	A7	N/A
Clo Mor	CMV	<i>Nairoviridae</i>	<i>Orthonairovirus</i>	2	S	Sakhalin
CoAr 1071	CA1071V	<i>Peribunyaviridae</i>	<i>Orthobunyavirus</i>	2	A7	N/A
CoAr 3627	CA3627V	<i>Peribunyaviridae</i>	<i>Orthobunyavirus</i>	2	A7	N/A
Coastal Plains	CPV	<i>Rhabdoviridae</i>	<i>Tibrovirus</i>	2	IE	Tibrogargan
Cocal	COCV	<i>Rhabdoviridae</i>	<i>Vesiculovirus</i>	2	A3	Vesicular Stomatitis
Cocle	CCLV	<i>Phenuiviridae</i>	<i>Phlebovirus</i>	2	A7	Punta Toro
Codajas	CDJV	<i>Reoviridae</i>	<i>Orbivirus</i>	2	A7	N/A
Colony	COYV	<i>Reoviridae</i>	<i>Orbivirus</i>	2	A7	N/A
Colony B North	CBNV	<i>Reoviridae</i>	<i>Orbivirus</i>	2	A7	N/A
Colorado tick fever	CTFV	<i>Reoviridae</i>	<i>Coltivirus</i>	2	S	Colorado Tick Fever
Crimean-Congo hemorrhagic fever	CCHFV	<i>Nairoviridae</i>	<i>Orthonairovirus</i>	4	A7	Crimean-Congo hemorrhagic fever
Connecticut	CNTV	<i>Rhabdoviridae</i>	Unassigned	2	IE	Sawgrass
Corfou	CFUV	<i>Phenuiviridae</i>	<i>Phlebovirus</i>	2	A7	Phlebotomus Fever
Corriparta	CORV	<i>Reoviridae</i>	<i>Orbivirus</i>	2	S	Corriparta
Cotia	COTV	<i>Poxviridae</i>	Unassigned	2	S	N/A
Cowbone Ridge	CRV	<i>Flaviviridae</i>	<i>Flavivirus</i>	2	S	N/A
Csiro Village	CVGV	<i>Reoviridae</i>	<i>Orbivirus</i>	2	S	Palyam
Cuiaba	CUIV	<i>Rhabdoviridae</i>	Unassigned	2	S	N/A
Cupixi	CPXV	<i>Arenaviridae</i>	<i>Mammarenavirus</i>	3	IE	N/A
Curionopolis	CRNPV	<i>Rhabdoviridae</i>	<i>Curiovirus</i>	2	A7	N/A
Dabakala	DABV	<i>Peribunyaviridae</i>	<i>Orthobunyavirus</i>	2	A7	Olifantsvlei
Dabieshan	DBSV	<i>Hantaviridae</i>	<i>Orthohantavirus</i>	3 ^a	A7	N/A
D'Aguilar	DAGV	<i>Reoviridae</i>	<i>Orbivirus</i>	2	S	Palyam
Dakar bat	DBV	<i>Flaviviridae</i>	<i>Flavivirus</i>	2	S	N/A
Dandenong	DANV	<i>Arenaviridae</i>	<i>Mammarenavirus</i>	2	A5	N/A
Dashli	DASHV	<i>Phenuiviridae</i>	<i>Phlebovirus</i>	2	A7	N/A
Deer tick	DRTV	<i>Flaviviridae</i>	<i>Flavivirus</i>	3	A7	N/A
Dengue virus 1	DENV-1	<i>Flaviviridae</i>	<i>Flavivirus</i>	2	S	N/A
Dengue virus 2	DENV-2	<i>Flaviviridae</i>	<i>Flavivirus</i>	2	S	N/A
Dengue virus 3	DENV-3	<i>Flaviviridae</i>	<i>Flavivirus</i>	2	S	N/A
Dengue virus 4	DENV-4	<i>Flaviviridae</i>	<i>Flavivirus</i>	2	S	N/A
Dera Ghazi Khan	DGKV	<i>Nairoviridae</i>	<i>Orthonairovirus</i>	2	S	Dera Ghazi Khan
Dobrava-Belgrade	DOBV	<i>Hantaviridae</i>	<i>Orthohantavirus</i>	3a	IE	N/A
Dhori	DHOV	<i>Orthomyxoviridae</i>	<i>Thogotovirus</i>	2	S	N/A
Douglas	DOUV	<i>Peribunyaviridae</i>	<i>Orthobunyavirus</i>	3	IE	Simbu
Durania	DURV	<i>Phenuiviridae</i>	<i>Phlebovirus</i>	2	A7	Phlebotomus Fever
Durham	DURV	<i>Rhabdoviridae</i>	<i>Tupavirus</i>	2	IE	N/A
Dugbe	DUGV	<i>Nairoviridae</i>	<i>Orthonairovirus</i>	3	S	Nairobi Sheep Disease
Eastern equine encephalitis	EEEV	<i>Togaviridae</i>	<i>Alphavirus</i>	3 ^b	S	Eastern Equine Encephalitis
Ebola	EBOV	<i>Filoviridae</i>	<i>Ebolavirus</i>	4	S	Ebola
Edge Hill	EHV	<i>Flaviviridae</i>	<i>Flavivirus</i>	2	S	N/A
EgAN 1825-61	EGAV	<i>Phenuiviridae</i>	<i>Phlebovirus</i>	2	A7	N/A
El Huayo	EHUV	<i>Peribunyaviridae</i>	<i>Orthobunyavirus</i>	2	A7	N/A

Continued on next page ►

Virus Name	Acronym	Family	Genus	Recommended BSL	Basis of Rating	Antigenic Group
El Moro Canyon	ELMCV	<i>Hantaviridae</i>	<i>Orthohantavirus</i>	3a	A7	N/A
Ellidaey	ELLV	<i>Reoviridae</i>	<i>Orbivirus</i>	2	A7	N/A
Enseada	ENSV	<i>Unclassified Bunyavirales</i>	N/A	3	IE	N/A
Entebbe bat	ENTV	<i>Flaviviridae</i>	<i>Flavivirus</i>	2	S	N/A
Epizootic hemorrhagic disease	EHDV	<i>Reoviridae</i>	<i>Orbivirus</i>	2	S	Epizootic Hemorrhagic Disease
Equine encephalosis	EEV	<i>Reoviridae</i>	<i>Orbivirus</i>	3	A1	N/A
Eret	ERETV	<i>Peribunyaviridae</i>	<i>Orthobunyavirus</i>	2	A7	N/A
Erve	ERVEV	<i>Nairoviridae</i>	<i>Orthonairovirus</i>	2	S	Thiafora
Escharte	ESCV	<i>Phenuiviridae</i>	<i>Phlebovirus</i>	3	IE	N/A
Essaouira	ESSV	<i>Reoviridae</i>	<i>Orbivirus</i>	2	A7	N/A
Estero Real	ERV	<i>Peribunyaviridae</i>	<i>Orthobunyavirus</i>	2	IE	Patois
Eubenangee	EUBV	<i>Reoviridae</i>	<i>Orbivirus</i>	2	S	Eubenangee
Everglades	EVEV	<i>Togaviridae</i>	<i>Alphavirus</i>	3	S	Venezuelan Equine Encephalitis
Eyach	EYAV	<i>Reoviridae</i>	<i>Coltivirus</i>	2	S	Colorado Tick Fever
Facey's Paddock	FPV	<i>Peribunyaviridae</i>	<i>Orthobunyavirus</i>	2	A7	N/A
Farallon	FARV	<i>Nairoviridae</i>	<i>Orthonairovirus</i>	2	A7	N/A
Farmington	FRMV	<i>Rhabdoviridae</i>	Unassigned	2	A7	N/A
Fermo	FERV	<i>Phenuiviridae</i>	<i>Phlebovirus</i>	2	A7	Sandfly Fever Naples
Fikirini	FKRV	<i>Rhabdoviridae</i>	<i>Ledantevirus</i>	2	A7	N/A
Fin V 707	FINV	<i>Phenuiviridae</i>	<i>Phlebovirus</i>	2	A7	N/A
Finch Creek	FINCV	<i>Nairoviridae</i>	<i>Orthonairovirus</i>	2	A7	N/A
Fitzroy River	FRV	<i>Flaviviridae</i>	<i>Flavivirus</i>	3	A7	Yellow Fever
Flanders	FLAV	<i>Rhabdoviridae</i>	<i>Hapavirus</i>	2	S	Hart Park
Flexal	FLEV	<i>Arenaviridae</i>	<i>Mammarenavirus</i>	3	S	Tacaribe
Fomede	FV	<i>Reoviridae</i>	<i>Orbivirus</i>	2	A7	Chobar Gorge
Forécariah	FORV	<i>Phenuiviridae</i>	<i>Phlebovirus</i>	2	A7	Bhanja
Fort Morgan	FMV	<i>Togaviridae</i>	<i>Alphavirus</i>	2	S	Western Equine Encephalitis
Fort Sherman	FSV	<i>Peribunyaviridae</i>	<i>Orthobunyavirus</i>	2	A7	Bunyamwera
Foula	FOUV	<i>Reoviridae</i>	<i>Orbivirus</i>	2	A7	N/A
Fraser Point	FPV	<i>Nairoviridae</i>	<i>Orthonairovirus</i>	2	A7	N/A
Frijoles	FRIV	<i>Phenuiviridae</i>	<i>Phlebovirus</i>	2	S	Phlebotomus Fever
Fugong	FUGV	<i>Hantaviridae</i>	<i>Orthohantavirus</i>	3*	IE	N/A
Fukuoka	FUKV	<i>Rhabdoviridae</i>	<i>Ledantevirus</i>	2	A7	N/A
Fusong	FUSV	<i>Hantaviridae</i>	<i>Orthohantavirus</i>	3	A7	N/A
Gabek Forest	GFV	<i>Phenuiviridae</i>	<i>Phlebovirus</i>	2	A7	Phlebotomus Fever
Gadgets Gully	GGYV	<i>Flaviviridae</i>	<i>Flavivirus</i>	2	IE	N/A
Gairo	GAIV	<i>Arenaviridae</i>	<i>Mammarenavirus</i>	3	A7	N/A
Gamboa	GAMV	<i>Peribunyaviridae</i>	<i>Orthobunyavirus</i>	2	S	Gamboa
Gan Gan	GGV	<i>Peribunyaviridae</i>	<i>Orthobunyavirus</i>	2	A7	Mapputta
Garatuba	GTBV	<i>Peribunyaviridae</i>	<i>Orthobunyavirus</i>	2	A7	N/A
Garba	GARV	<i>Rhabdoviridae</i>	Unassigned	2	IE	Matariva
Garissa	GRSV	<i>Peribunyaviridae</i>	<i>Orthobunyavirus</i>	3	A7	Bunyamwera
Geran	GERV	<i>Nairoviridae</i>	<i>Orthonairovirus</i>	2	A7	N/A
Germiston	GERV	<i>Peribunyaviridae</i>	<i>Orthobunyavirus</i>	3		Bunyamwera
Getah	GETV	<i>Togaviridae</i>	<i>Alphavirus</i>	2	A1	Semliki Forest

Continued on next page ►

Virus Name	Acronym	Family	Genus	Recommended BSL	Basis of Rating	Antigenic Group
Gomoka	GOMV	<i>Reoviridae</i>	<i>Orbivirus</i>	2	S	Ieri
Gordil	GORV	<i>Phenuiviridae</i>	<i>Phlebovirus</i>	2	IE	Phlebotomus Fever
Gossas	GOSV	<i>Nairoviridae</i>	<i>Orthonairovirus</i>	2	S	N/A
Gou	GOUV	<i>Hantaviridae</i>	<i>Orthohantavirus</i>	2 ^a	IE	N/A
Gouleako	GOLV	<i>Phenuiviridae</i>	<i>Goukovirus</i>	3	IE	N/A
Granada	GRAV	<i>Phenuiviridae</i>	<i>Phlebovirus</i>	2	A7	N/A
Grand Arbaud	GAV	<i>Phenuiviridae</i>	<i>Phlebovirus</i>	2	S	Uukuniemi
Gray Lodge	GLOV	<i>Rhabdoviridae</i>	<i>Hapavirus</i>	2	IE	Vesicular Stomatitis
Great Island	GIV	<i>Reoviridae</i>	<i>Orbivirus</i>	2	S	Kemerovo
Great Saltee	GRSV	<i>Nairoviridae</i>	<i>Orthonairovirus</i>	2	A7	N/A
Great Saltee Island	GSIV	<i>Reoviridae</i>	<i>Orbivirus</i>	2	A7	N/A
Grimsey	GSYV	<i>Reoviridae</i>	<i>Orbivirus</i>	2	A7	N/A
Guajar�a	GJAV	<i>Peribunyaviridae</i>	<i>Orthobunyavirus</i>	2	S	Capim
Guam�a	GMAV	<i>Peribunyaviridae</i>	<i>Orthobunyavirus</i>	2	S	Guama
Guanarito	GTOV	<i>Arenaviridae</i>	<i>Mammarenavirus</i>	4	A4	Tacaribe
Guarutuba	GTBV	<i>Peribunyaviridae</i>	<i>Orthobunyavirus</i>	2	A7	Guama
Guaroa	GROV	<i>Peribunyaviridae</i>	<i>Orthobunyavirus</i>	2	S	California
Gumbo Limbo	GLV	<i>Peribunyaviridae</i>	<i>Orthobunyavirus</i>	2	S	N/A
Gurupi	GURV	<i>Reoviridae</i>	<i>Orbivirus</i>	2	IE	Changuinola
Gweru	GWV	<i>Reoviridae</i>	<i>Orbivirus</i>	2	A7	N/A
Hantaan	HTNV	<i>Hantaviridae</i>	<i>Orthohantavirus</i>	3 ^a	S	Hantaan
Hanzalova	HANV	<i>Flaviviridae</i>	<i>Flavivirus</i>	4	A4	Tick-borne Encephalitis—CE subtype
Hart Park	HPV	<i>Rhabdoviridae</i>	<i>Hapavirus</i>	2	S	Hart Park
Hazara	HAZV	<i>Nairoviridae</i>	<i>Orthonairovirus</i>	2	S	CCHF
Heartland	HRTV	<i>Phenuiviridae</i>	<i>Phlebovirus</i>	3	IE	N/A
Highlands J	HJV	<i>Togaviridae</i>	<i>Alphavirus</i>	2	S	Western Equine Encephalitis
Huacho	HUAV	<i>Reoviridae</i>	<i>Orbivirus</i>	2	S	Kemerovo
Hughes	HUGV	<i>Nairoviridae</i>	<i>Orthonairovirus</i>	2	S	Hughes
Hunter Island	HUIV	<i>Phenuiviridae</i>	<i>Phlebovirus</i>	3	IE	N/A
Hypr	HYPRV	<i>Flaviviridae</i>	<i>Flavivirus</i>	4	S	Tick-borne Encephalitis—CE subtype
Iaco	IACOV	<i>Peribunyaviridae</i>	<i>Orthobunyavirus</i>	2	IE	Bunyamwera
Ibaraki	IBAV	<i>Reoviridae</i>	<i>Orbivirus</i>	2	IE	Epizootic Hemorrhagic Disease
Icoaraci	ICOV	<i>Phenuiviridae</i>	<i>Phlebovirus</i>	2	S	Phlebotomus Fever
Ieri	IERIV	<i>Reoviridae</i>	<i>Orbivirus</i>	2	S	Ieri
Ife	IFEV	<i>Reoviridae</i>	<i>Orbivirus</i>	2	IE	N/A
Iguape	IGUV	<i>Flaviviridae</i>	<i>Flavivirus</i>	2	A7	N/A
Ilesha	ILEV	<i>Peribunyaviridae</i>	<i>Orthobunyavirus</i>	2	S	Bunyamwera
Ilh�us	ILHV	<i>Flaviviridae</i>	<i>Flavivirus</i>	2	S	N/A
Imjin	MJNV	<i>Hantaviridae</i>	<i>Orthohantavirus</i>	3 ^a	IE	N/A
Infirmitatus	INFV	<i>Peribunyaviridae</i>	<i>Orthobunyavirus</i>	2	A7	California
Ingwavuma	INGV	<i>Peribunyaviridae</i>	<i>Orthobunyavirus</i>	2	S	Simbu
Inhangapi	INHV	<i>Rhabdoviridae</i>	Unassigned	2	IE	N/A
Inini	INIV	<i>Peribunyaviridae</i>	<i>Orthobunyavirus</i>	2	IE	Simbu
Inkoo	INKV	<i>Peribunyaviridae</i>	<i>Orthobunyavirus</i>	2	S	California
Inner Farne	INFV	<i>Reoviridae</i>	<i>Orbivirus</i>	2	A7	N/A

Continued on next page ►

Virus Name	Acronym	Family	Genus	Recommended BSL	Basis of Rating	Antigenic Group
Ippy	IPPYV	<i>Arenaviridae</i>	<i>Mammarenavirus</i>	2	S	Tacaribe
Iquitos	IQTV	<i>Peribunyaviridae</i>	<i>Orthobunyavirus</i>	2	A7	N/A
Iriri	IRRV	<i>Rhabdoviridae</i>	<i>Curivirus</i>	2	A7	N/A
Irituia	IRIV	<i>Reoviridae</i>	<i>Orbivirus</i>	2	S	Changuinola
Isfahan	ISFV	<i>Rhabdoviridae</i>	<i>Vesiculovirus</i>	2	S	Vesicular Stomatitis
Israel turkey meningoencephalitis	ITV	<i>Flaviviridae</i>	<i>Flavivirus</i>	2 with 3 practices	S	N/A
Issyk-Kul	ISKV	<i>Nairoviridae</i>	<i>Orthonairovirus</i>	3	IE	N/A
Itacaiunas	ITCNV	<i>Rhabdoviridae</i>	<i>Curivirus</i>	2	A7	N/A
Itaituba	ITAV	<i>Phenuiviridae</i>	<i>Phlebovirus</i>	2	IE	Phlebotomus Fever
Itaporanga	ITPV	<i>Phenuiviridae</i>	<i>Phlebovirus</i>	2	S	Phlebotomus Fever
Itaqui	ITQV	<i>Peribunyaviridae</i>	<i>Orthobunyavirus</i>	2	S	N/A
Itaya		<i>Peribunyaviridae</i>	<i>Orthobunyavirus</i>	2	A7	N/A
Itimirim	ITIV	<i>Peribunyaviridae</i>	<i>Orthobunyavirus</i>	2	IE	Guama
Itupiranga	ITUV	<i>Reoviridae</i>	<i>Orbivirus</i>	2	II	N/A
Ixcanal	IXCV	<i>Phenuiviridae</i>	<i>Phlebovirus</i>	2	A7	Phlebotomus Fever
Jacareacanga	JACV	<i>Reoviridae</i>	<i>Orbivirus</i>	2	IE	Corripata
Jacunda	JCNV	<i>Phenuiviridae</i>	<i>Phlebovirus</i>	2	A7	Phlebotomus Fever
Jamanxi	JAMV	<i>Reoviridae</i>	<i>Orbivirus</i>	2	IE	Changuinola
Jamestown Canyon	JCV	<i>Peribunyaviridae</i>	<i>Orthobunyavirus</i>	2	S	California
Japanaut	JAPV	<i>Reoviridae</i>	<i>Orbivirus</i>	2	S	N/A
Japanese encephalitis	JEV	<i>Flaviviridae</i>	<i>Flavivirus</i>	3*	S	N/A
Jari	JARIV	<i>Reoviridae</i>	<i>Orbivirus</i>	2	IE	Changuinola
Jatobal	JTBV	<i>Preibunyaviridae</i>	<i>Orthobunyavirus</i>	2	A7	N/A
Jeju	JJUV	<i>Hantaviridae</i>	<i>Orthohantavirus</i>	3*	A7	N/A
Jerry Slough	JSV	<i>Peribunyaviridae</i>	<i>Orthobunyavirus</i>	2	S	California
Joa	JOAV	<i>Phenuiviridae</i>	<i>Phlebovirus</i>	2	A7	N/A
Johnston Atoll	JAV	<i>Orthomyxoviridae</i>	<i>Quarantavirus</i>	2	S	Quaranfil
Joinjakaka	JOIV	<i>Rhabdoviridae</i>	<i>Hapavirus</i>	2	S	N/A
Juan Diaz	JDV	<i>Peribunyaviridae</i>	<i>Orthobunyavirus</i>	2	S	Capim
Jugra	JUGV	<i>Flaviviridae</i>	<i>Flavivirus</i>	2	S	N/A
Junin	JUNV	<i>Arenaviridae</i>	<i>Mammarenavirus</i>	4	A6	Tacaribe
Juquitiba	JUQV	<i>Hantaviridae</i>	<i>Orthohantavirus</i>	3*	A7	N/A
Jurona	JURV	<i>Rhabdoviridae</i>	<i>Vesiculovirus</i>	2	S	Vesicular Stomatitis
Juruaca	JRCV	<i>Picomaviridae</i>	Unassigned	2	A7	N/A
Jutiapa	JUTV	<i>Flaviviridae</i>	<i>Flavivirus</i>	2	S	N/A
Kabuto Mountain	KAMV	<i>Phenuiviridae</i>	<i>Phlebovirus</i>	2	A7	N/A
Kachemak Bay	KBV	<i>Nairoviridae</i>	<i>Orthonairovirus</i>	2	A7	N/A
Kadam	KADV	<i>Flaviviridae</i>	<i>Flavivirus</i>	2	S	N/A
Kaeng Khoi	KKV	<i>Peribunyaviridae</i>	<i>Orthobunyavirus</i>	2	S	N/A
Kaikalur	KAIV	<i>Peribunyaviridae</i>	<i>Orthobunyavirus</i>	2	S	Simbu
Kairi	KRIV	<i>Peribunyaviridae</i>	<i>Orthobunyavirus</i>	2	A1	Bunyamwera
Kaisodi	KSOV	<i>Unclassified Bunyavirales</i>	N/A	2	S	Kaisodi
Kala Iris	KIRV	<i>Reoviridae</i>	<i>Orbivirus</i>	2	A7	N/A
Kamese	KAMV	<i>Rhabdoviridae</i>	<i>Hapavirus</i>	2	S	Hart Park
Kammavanpettai	KMPV	<i>Reoviridae</i>	<i>Orbivirus</i>	2	S	N/A

Continued on next page ►

Virus Name	Acronym	Family	Genus	Recommended BSL	Basis of Rating	Antigenic Group
Kannamangalam	KANV	<i>Rhabdoviridae</i>	Unassigned	2	S	N/A
Kanyawara	KYAV	<i>Rhabdoviridae</i>	<i>Ledantavirus</i>	2	A7	N/A
Kao Shuan	KSV	<i>Nairoviridae</i>	<i>Orthonairovirus</i>	2	S	N/A
Karimabad	KARV	<i>Phenuiviridae</i>	<i>Phlebovirus</i>	2	S	N/A
Karshi	KSIV	<i>Flaviviridae</i>	<i>Flavivirus</i>	2	S	N/A
Kasba	KASV	<i>Reoviridae</i>	<i>Orbivirus</i>	2	S	N/A
Kasokero	KASV	<i>Nairoviridae</i>	<i>Orthonairovirus</i>	2	A7	N/A
Kédougou	KEDV	<i>Flaviviridae</i>	<i>Flavivirus</i>	2	A7	N/A
Kemerovo	KEMV	<i>Reoviridae</i>	<i>Orbivirus</i>	2	S	N/A
Kenai	KENV	<i>Reoviridae</i>	<i>Orbivirus</i>	2	A7	N/A
Kenkeme	KKMV	<i>Hantaviridae</i>	<i>Orthohantavirus</i>	3 ^a	A7	N/A
Kern Canyon	KCV	<i>Rhabdoviridae</i>	<i>Ledantavirus</i>	2	S	N/A
Ketapang	KETV	<i>Peribunyaviridae</i>	<i>Orthobunyavirus</i>	2	S	N/A
Keterah	KTRV	<i>Nairoviridae</i>	<i>Orthonairovirus</i>	2	S	N/A
Keuraliba	KEUV	<i>Rhabdoviridae</i>	<i>Ledantavirus</i>	2	S	N/A
Keystone	KEYV	<i>Peribunyaviridae</i>	<i>Orthobunyavirus</i>	2	S	California
Khabarovsk	KHAV	<i>Hantaviridae</i>	<i>Orthohantavirus</i>	3 ^a	IE	Hantaan
Kharagysh	KHAV	<i>Reoviridae</i>	<i>Orbivirus</i>	2	A7	N/A
Khasan	KHAV	<i>Phenuiviridae</i>	<i>Phlebovirus</i>	2	IE	CCHF
Khatanga	KHATV	<i>Peribunyaviridae</i>	<i>Orthobunyavirus</i>	2	A7	N/A
Kimberley	KIMV	<i>Rhabdoviridae</i>	<i>Ephemerovirus</i>	2	A7	Bovine Ephemeral Fever
Kindia	KINV	<i>Reoviridae</i>	<i>Orbivirus</i>	2	A7	Palyam
Kismayo	KISV	<i>Phenuiviridae</i>	<i>Phlebovirus</i>	2	S	Bhanja
Klamath	KLAV	<i>Rhabdoviridae</i>	<i>Tupavirus</i>	2	S	Vesicular Stomatitis
Kokobera	KOKV	<i>Flaviviridae</i>	<i>Flavivirus</i>	2	S	N/A
Kolente	KOLEV	<i>Rhabdoviridae</i>	<i>Ledantavirus</i>	2	A7	N/A
Kolongo	KOLV	<i>Rhabdoviridae</i>	Unassigned	2	S	Rab
Komandory	KOMV	<i>Phenuiviridae</i>	<i>Phlebovirus</i>	2	IE	N/A
Koongol	KOOV	<i>Peribunyaviridae</i>	<i>Orthobunyavirus</i>	2	S	Koongol
Kotonkan	KOTV	<i>Rhabdoviridae</i>	<i>Ephemerovirus</i>	2	S	Rab
Koutango	KOUV	<i>Flaviviridae</i>	<i>Flavivirus</i>	3	S	N/A
Kowanyama	KOWV	<i>Peribunyaviridae</i>	<i>Orthobunyavirus</i>	2	S	N/A
Kumlinge	KUMV	<i>Flaviviridae</i>	<i>Flavivirus</i>	4	A4	Tick-borne Encephalitis— CE subtype
Kunjín	KUNV	<i>Flaviviridae</i>	<i>Flavivirus</i>	2	S	N/A
Kununurra	KNAV	<i>Rhabdoviridae</i>	Unassigned	2	S	N/A
Kupe	KUPV	<i>Nairoviridae</i>	<i>Orthonairovirus</i>	3	IE	N/A
Kwatta	KWAV	<i>Rhabdoviridae</i>	Unassigned	2	S	Vesicular Stomatitis
Kyasanur Forest disease	KFDV	<i>Flaviviridae</i>	<i>Flavivirus</i>	4	S	N/A
Kyzylgach	KYZV	<i>Togaviridae</i>	<i>Alphavirus</i>	2	IE	Western Equine Encephalitis
La Crosse	LACV	<i>Peribunyaviridae</i>	<i>Orthobunyavirus</i>	2	S	California
Lagos bat	LBV	<i>Rhabdoviridae</i>	<i>Lyssavirus</i>	2	S	Rab
Laguna Negra	LANV	<i>Hantaviridae</i>	<i>Orthohantavirus</i>	3 ^a	IE	N/A
Laibin	LAIV	<i>Hantaviridae</i>	<i>Orthohantavirus</i>	3 ^a	IE	N/A
La Joya	LJV	<i>Rhabdoviridae</i>	<i>Hapavirus</i>	2	S	Vesicular Stomatitis
Lake Chad	LKCV	<i>Orthomyxoviridae</i>	<i>Quarantavirus</i>	2	A7	N/A

Continued on next page ►

Virus Name	Acronym	Family	Genus	Recommended BSL	Basis of Rating	Antigenic Group
Lake Clarendon	LCV	<i>Reoviridae</i>	<i>Orbivirus</i>	2	IE	N/A
Landjia	LJAV	<i>Rhabdoviridae</i>	<i>Hapavirus</i>	2	S	N/A
Langat	LGTV	<i>Flaviviridae</i>	<i>Flavivirus</i>	2	S	N/A
Lanjan	LJNV	<i>Unclassified Bunyavirales</i>	N/A	2	S	Kaisodi
Las Maloyas	LMV	<i>Peribunyaviridae</i>	<i>Orthobunyavirus</i>	2	A7	Anopheles A
Lassa	LASV	<i>Arenaviridae</i>	<i>Mammarenavirus</i>	4	S	N/A
Latino	LATV	<i>Arenaviridae</i>	<i>Mammarenavirus</i>	2	A5	Tacaribe
Leanyer	LEAV	<i>Peribunyaviridae</i>	<i>Orthobunyavirus</i>	2	A7	N/A
Lebombo	LEBV	<i>Reoviridae</i>	<i>Orbivirus</i>	2	S	N/A
Lechiguanas	LECHV	<i>Hantaviridae</i>	<i>Orthohantavirus</i>	3*	IE	Hantaan
Le Dantec	LDV	<i>Rhabdoviridae</i>	<i>Ledantavirus</i>	2	S	Le Dantec
Lednice	LEDV	<i>Peribunyaviridae</i>	<i>Orthobunyavirus</i>	2	A7	Turlock
Leopards Hill	LPHV	<i>Nairoviridae</i>	<i>Orthonairovirus</i>	2	A7	N/A
Leticia	LTCV	<i>Phenuiviridae</i>	<i>Phlebovirus</i>	2	A7	Punta Toro
Lipovnik	LIPV	<i>Reoviridae</i>	<i>Orbivirus</i>	2	S	Kemerovo
Llano Seco	LLSV	<i>Reoviridae</i>	<i>Orbivirus</i>	2	IE	Umatilla
Loei River	LORV	<i>Arenaviridae</i>	<i>Mammarenavirus</i>	3	IE	N/A
Lokern	LOKV	<i>Peribunyaviridae</i>	<i>Orthobunyavirus</i>	2	S	Bunyamwera
Lone Star	LSV	<i>Phenuiviridae</i>	<i>Phlebovirus</i>	2	S	N/A
Longquan	LQUV	<i>Hantaviridae</i>	<i>Orthohantavirus</i>	3*	IE	N/A
Louping Ill	LIV	<i>Flaviviridae</i>	<i>Flavivirus</i>	3*	S	N/A
Lujo	LUJV	<i>Arenaviridae</i>	<i>Mammarenavirus</i>	4	A4	N/A
Lukuni	LUKV	<i>Peribunyaviridae</i>	<i>Orthobunyavirus</i>	2	S	Anopheles A
Lumbo	LUMV	<i>Peribunyaviridae</i>	<i>Orthobunyavirus</i>	2	A7	N/A
Luna	LUNV	<i>Arenaviridae</i>	<i>Mammarenavirus</i>	3	A7	N/A
Lundy	LUNV	<i>Reoviridae</i>	<i>Orbivirus</i>	2	A7	N/A
Lunk	LNKV	<i>Arenaviridae</i>	<i>Mammarenavirus</i>	3	IE	N/A
Luxi	LUXV	<i>Hantaviridae</i>	<i>Orthohantavirus</i>	3*	IE	N/A
Lymphocytic choriomeningitis	LCMV	<i>Arenaviridae</i>	<i>Mammarenavirus</i>	2	A5	N/A
Macaua	MCAV	<i>Peribunyaviridae</i>	<i>Orthobunyavirus</i>	2	IE	Bunyamwera
Machupo	MACV	<i>Arenaviridae</i>	<i>Mammarenavirus</i>	4	S	Tacaribe
Maciel	MCLV	<i>Hantaviridae</i>	<i>Orthohantavirus</i>	3*	IE	N/A
Madariaga	MADV	<i>Togaviridae</i>	<i>Alphavirus</i>	3	A7	Eastern Equine Encephalitis
Madre de Dios	MDDV	<i>Peribunyaviridae</i>	<i>Orthobunyavirus</i>	2	A7	N/A
Madrid	MADV	<i>Peribunyaviridae</i>	<i>Orthobunyavirus</i>	2	S	N/A
Maguari	MAGV	<i>Peribunyaviridae</i>	<i>Orthobunyavirus</i>	2	S	Bunyamwera
Mahogany Hammock	MHV	<i>Peribunyaviridae</i>	<i>Orthobunyavirus</i>	2	S	Guama
Maiden	MDNV	<i>Reoviridae</i>	<i>Orbivirus</i>	2	A7	N/A
Main Drain	MDV	<i>Peribunyaviridae</i>	<i>Orthobunyavirus</i>	2	S	Bunyamwera
Malakal	MALV	<i>Rhabdoviridae</i>	<i>Ephemerovirus</i>	2	S	Bovine Ephemerol
Maldonado	MLOV	<i>Phenuiviridae</i>	<i>Phlebovirus</i>	2	A7	Candiru
Malsoor	MALV	<i>Phenuiviridae</i>	<i>Phlebovirus</i>	3	IE	N/A
Manawa	MWAV	<i>Phenuiviridae</i>	<i>Phlebovirus</i>	2	S	Uukuniemi
Manitoba	MNTBV	<i>Rhabdoviridae</i>	<i>Hapavirus</i>	2	A7	N/A
Manzanilla	MANV	<i>Peribunyaviridae</i>	<i>Orthobunyavirus</i>	2	S	Simbu

Continued on next page ►

Virus Name	Acronym	Family	Genus	Recommended BSL	Basis of Rating	Antigenic Group
Mapputta	MAPV	<i>Peribunyaviridae</i>	<i>Orthobunyavirus</i>	2	S	Mapputta
Maporal	MAPV	<i>Hantaviridae</i>	<i>Orthohantavirus</i>	3 ^a	IE	Hantaan
Maprik	MPKV	<i>Peribunyaviridae</i>	<i>Orthobunyavirus</i>	2	S	Mapputta
Maraba	MARAV	<i>Rhabdoviridae</i>	<i>Vesiculovirus</i>	2	A7	N/A
Marajo	MRJV	<i>Unclassified virus</i>	N/A	2	IE	N/A
Marburg	MARV	<i>Filoviridae</i>	<i>Marburgvirus</i>	4	S	Marburg
Marco	MCOV	<i>Rhabdoviridae</i>	<i>Hapavirus</i>	2	S	N/A
Mariental	MRLV	<i>Arenaviridae</i>	<i>Mammarenavirus</i>	3	IE	N/A
Maripa	MARV	<i>Hantaviridae</i>	<i>Orthohantavirus</i>	3 ^a	IE	N/A
Mariquita	MRQV	<i>Phenuiviridae</i>	<i>Phlebovirus</i>	2	A7	N/A
Marituba	MTBV	<i>Peribunyaviridae</i>	<i>Orthobunyavirus</i>	2	S	N/A
Marondera	MRDV	<i>Reoviridae</i>	<i>Orbivirus</i>	2	A7	N/A
Marrakai	MARV	<i>Reoviridae</i>	<i>Orbivirus</i>	2	S	N/A
Massila	MASV	<i>Phenuiviridae</i>	<i>Phlebovirus</i>	2	A7	N/A
Matariya	MTYV	<i>Rhabdoviridae</i>	Unassigned	2	S	N/A
Matruh	MTRV	<i>Peribunyaviridae</i>	<i>Orthobunyavirus</i>	2	S	N/A
Matucare	MATV	<i>Reoviridae</i>	<i>Orbivirus</i>	2	S	N/A
Mayaro	MAYV	<i>Togaviridae</i>	<i>Alphavirus</i>	2	S	Semliki Forest
Mboke	MBOV	<i>Peribunyaviridae</i>	<i>Orthobunyavirus</i>	2	A7	N/A
Mburo	MBUV	<i>Peribunyaviridae</i>	<i>Orthobunyavirus</i>	2	A7	N/A
Meaban	MEAV	<i>Flaviviridae</i>	<i>Flavivirus</i>	2	IE	N/A
Medjerda Valley	MVV	<i>Phenuiviridae</i>	<i>Phlebovirus</i>	2	A7	N/A
Melao	MELV	<i>Peribunyaviridae</i>	<i>Orthobunyavirus</i>	2	S	California
Merino Walk	MWV	<i>Arenaviridae</i>	<i>Mammarenavirus</i>	3	IE	N/A
Mermet	MERV	<i>Peribunyaviridae</i>	<i>Orthobunyavirus</i>	2	S	Simbu
Middelburg	MIDV	<i>Togaviridae</i>	<i>Alphavirus</i>	2	A1	Middelburg
Mill Door	MDR	<i>Reoviridae</i>	<i>Orbivirus</i>	2	A7	N/A
Minacu	N/A	<i>Reoviridae</i>	<i>Orbivirus</i>	2	IE	N/A
Minatitlan	MNTV	<i>Peribunyaviridae</i>	<i>Orthobunyavirus</i>	2	S	Minatitlan
Minnal	MINV	<i>Reoviridae</i>	<i>Orbivirus</i>	2	S	Umatilla
Mirim	MIRV	<i>Peribunyaviridae</i>	<i>Orthobunyavirus</i>	2	S	Guama
Mitchell River	MRV	<i>Reoviridae</i>	<i>Orbivirus</i>	2	S	N/A
Mobala	MOBV	<i>Arenaviridae</i>	<i>Mammarenavirus</i>	3	A7	Tacaribe
Modoc	MODV	<i>Flaviviridae</i>	<i>Flavivirus</i>	2	S	N/A
Moju	MOJUV	<i>Peribunyaviridae</i>	<i>Orthobunyavirus</i>	2	S	Guama
Mojui Dos Campos	MDCV	<i>Peribunyaviridae</i>	<i>Orthobunyavirus</i>	2	IE	N/A
Mono Lake	MLV	<i>Reoviridae</i>	<i>Orbivirus</i>	2	S	Kemerovo
Monongahela	MGLV	<i>Hantaviridae</i>	<i>Orthohantavirus</i>	3 ^a	A7	N/A
Montana myotis leukoencephalitis	MMLV	<i>Flaviviridae</i>	<i>Flavivirus</i>	2	S	N/A
Montano	MTNV	<i>Hantaviridae</i>	<i>Orthohantavirus</i>	3 ^a	A7	N/A
Monte Dourado	MDOV	<i>Reoviridae</i>	<i>Orbivirus</i>	2	IE	Changuinola
Mopeia	MOPV	<i>Arenaviridae</i>	<i>Mammarenavirus</i>	3	A7	N/A
Moriche	MORV	<i>Peribunyaviridae</i>	<i>Orthobunyavirus</i>	2	S	Capim
Morolillo	MOLV	<i>Phenuiviridae</i>	<i>Phlebovirus</i>	3	IE	N/A
Morreton	MORV	<i>Rhabdoviridae</i>	<i>Vesiculovirus</i>	2	A7	Vesicular Stomatitis
Morro Bay	MBV	<i>Peribunyaviridae</i>	<i>Orthobunyavirus</i>	2	IE	California

Continued on next page ►

Virus Name	Acronym	Family	Genus	Recommended BSL	Basis of Rating	Antigenic Group
Morogoro	MORV	<i>Arenaviridae</i>	<i>Mammarenavirus</i>	3	A7	N/A
Morumbi	MRMBV	<i>Phenuiviridae</i>	<i>Phlebovirus</i>	2	A7	Phlebotomus Fever
Mosqueiro	MQOV	<i>Rhabdoviridae</i>	<i>Hapavirus</i>	2	A7	Hart Park
Mosso das Pedras	MDPV	<i>Togaviridae</i>	<i>Alphavirus</i>	3	A7	Venezuelan Equine Encephalitis
Mossuril	MOSV	<i>Rhabdoviridae</i>	<i>Hapavirus</i>	2	S	Hart Park
Mount Elgon bat	MEBV	<i>Rhabdoviridae</i>	<i>Ledantevirus</i>	2	S	Vesicular Stomatitis
Mudjinbary	MUDV	<i>Reoviridae</i>	<i>Orbivirus</i>	2	A7	N/A
Muju	MUJV	<i>Hantaviridae</i>	<i>Orthohantavirus</i>	2 ^a	A8	N/A
Muleshoe	MULV	<i>Hantaviridae</i>	<i>Orthohantavirus</i>	2 ^a	A8	N/A
M'Poko	MPOV	<i>Peribunyaviridae</i>	<i>Orthobunyavirus</i>	2	S	Turlock
Mucambo	MUCV	<i>Togaviridae</i>	<i>Alphavirus</i>	3	S	Venezuelan Equine Encephalitis
Mucura	MCRV	<i>Phenuiviridae</i>	<i>Phlebovirus</i>	2	A7	Phlebotomus Fever
Munguba	MUNV	<i>Phenuiviridae</i>	<i>Phlebovirus</i>	2	IE	Phlebotomus Fever
Murray Valley encephalitis	MVEV	<i>Flaviviridae</i>	<i>Flavivirus</i>	3	S	N/A
Murre	MURV	<i>Phenuiviridae</i>	<i>Phlebovirus</i>	2	A7	N/A
Murutucú	MURV	<i>Peribunyaviridae</i>	<i>Orthobunyavirus</i>	2	S	N/A
Mykines	MYKV	<i>Reoviridae</i>	<i>Orbivirus</i>	2	A7	Kemerovo
Nairobi sheep disease	NSDV	<i>Nairoviridae</i>	<i>Orthonairovirus</i>	3 ^a	A1	Nairobi Sheep Disease
Nanjianyin	N/A	<i>Flaviviridae</i>	<i>Flavivirus</i>	4	A4	Tick-borne Encephalitis—CE subtype
Naranjal	NJLV	<i>Flaviviridae</i>	<i>Flavivirus</i>	2	IE	N/A
Nasoule	NASV	<i>Rhabdoviridae</i>	Unassigned	2	A7	Rab
Navarro	NAVV	<i>Rhabdoviridae</i>	Unassigned	2	S	N/A
Ndumu	NDUV	<i>Togaviridae</i>	<i>Alphavirus</i>	2	A1	Ndumu
Necocli	NECV	<i>Hantaviridae</i>	<i>Orthohantavirus</i>	3 ^a	A7	N/A
Negishi	NEGV	<i>Flaviviridae</i>	<i>Flavivirus</i>	3	S	Tick-borne Encephalitis—CE subtype
Nepuyo	NEPV	<i>Peribunyaviridae</i>	<i>Orthobunyavirus</i>	2	S	N/A
Netivot	NETV	<i>Reoviridae</i>	<i>Orbivirus</i>	2	A7	N/A
New Minto	NMV	<i>Rhabdoviridae</i>	Unassigned	2	IE	Sawgrass
New York	NYOV	<i>Hantaviridae</i>	<i>Orthohantavirus</i>	3 ^a	A7	N/A
Ngaingan	NGAV	<i>Rhabdoviridae</i>	<i>Hapavirus</i>	2	S	Tibrogargan
Ngaric	NRIV	<i>Peribunyaviridae</i>	<i>Orthobunyavirus</i>	3	A7	Bunyamwera
Ngooue	NGOV	<i>Reoviridae</i>	<i>Orbivirus</i>	2	A7	Eubanangée
Ninarumi	NRUV	<i>Reoviridae</i>	<i>Orbivirus</i>	3	A7	N/A
Nique	NIQV	<i>Phenuiviridae</i>	<i>Phlebovirus</i>	2	S	Phlebotomus Fever
Nkolbisson	NKOV	<i>Rhabdoviridae</i>	<i>Ledantevirus</i>	2	S	Kern Canyon
Nodamura	NOV	<i>Nodaviridae</i>	<i>Alphanodavirus</i>	2	IE	N/A
Nola	NOLAV	<i>Peribunyaviridae</i>	<i>Orthobunyavirus</i>	2	S	Bakau
North Clett	NCLV	<i>Reoviridae</i>	<i>Orbivirus</i>	2	A7	N/A
North Creek	NORCV	<i>Rhabdoviridae</i>	Unassigned	2	A7	N/A
North End	NEDV	<i>Reoviridae</i>	<i>Orbivirus</i>	2	A7	N/A
Northway	NORV	<i>Peribunyaviridae</i>	<i>Orthobunyavirus</i>	2	IE	Bunyamwera
Nova	NVAV	<i>Hantaviridae</i>	<i>Orthohantavirus</i>	3 ^a	IE	N/A
Ntaya	NTAV	<i>Flaviviridae</i>	<i>Flavivirus</i>	2	S	N/A
Nugget	NUGV	<i>Reoviridae</i>	<i>Orbivirus</i>	2	S	Kemerovo

Continued on next page ►

Virus Name	Acronym	Family	Genus	Recommended BSL	Basis of Rating	Antigenic Group
Nyabira	NYAV	<i>Reoviridae</i>	<i>Orbivirus</i>	2	A7	N/A
Nyamanini	NYMV	<i>Nyamaniniidae</i>	<i>Nyavirus</i>	2	S	Nyamanini
Nyando	NDV	<i>Peribunyaviridae</i>	<i>Orthobunyavirus</i>	2	S	Nyando
Oceanside	OCV	<i>Phenuiviridae</i>	<i>Phlebovirus</i>	2	A7	N/A
Oak Vale	OVV	<i>Rhabdoviridae</i>	Unassigned	2	A7	N/A
Ockelbo	N/A	<i>Togaviridae</i>	<i>Alphavirus</i>	2	A7	Western Equine Encephalitis
Odrenisrou	ODRV	<i>Phenuiviridae</i>	<i>Phlebovirus</i>	2	A7	Phlebotomus Fever
Oita	OITAV	<i>Rhabdoviridae</i>	<i>Ledantavirus</i>	2	A7	N/A
Okahandja	OKAV	<i>Arenaviridae</i>	<i>Mammarenavirus</i>	3	IE	N/A
Okhotskiy	OKHV	<i>Reoviridae</i>	<i>Orbivirus</i>	2	S	Kemerovo
Okola	OKOV	<i>Unclassified Bunyvirales</i>		2	S	Tanga
Olbia	OLBV	<i>Phenuiviridae</i>	<i>Phlebovirus</i>	2	A7	N/A
Olifantsvlei	OLIV	<i>Peribunyaviridae</i>	<i>Orthobunyavirus</i>	2	S	Olifantsvlei
Oliveros	OLV	<i>Arenaviridae</i>	<i>Mammarenavirus</i>	3	A7	N/A
Omo	OMOV	<i>Nairoviridae</i>	<i>Orthonairovirus</i>	2	A7	Qalyub
Omsk hemorrhagic fever	OHFV	<i>Flaviviridae</i>	<i>Flavivirus</i>	4	S	N/A
O'nyong-nyong	ONNV	<i>Togaviridae</i>	<i>Alphavirus</i>	2	S	Semliki Forest
Orán	ORANV	<i>Hantaviridae</i>	<i>Orthohantavirus</i>	3 ^a	IE	Hantaan
Oriboca	ORIV	<i>Peribunyaviridae</i>	<i>Orthobunyavirus</i>	2	S	N/A
Oriximiná	ORXV	<i>Phenuiviridae</i>	<i>Phlebovirus</i>	2	IE	Phlebotomus Fever
Oropouche	OROV	<i>Peribunyaviridae</i>	<i>Orthobunyavirus</i>	2	S	Simbu
Orungo	ORUV	<i>Reoviridae</i>	<i>Orbivirus</i>	2	S	Orungo
Ossa	OSSAV	<i>Peribunyaviridae</i>	<i>Orthobunyavirus</i>	2	S	N/A
Ouangou	OOUAV	<i>Rhabdoviridae</i>	Unassigned	2	IE	N/A
Oubangui	OUBV	<i>Poxviridae</i>	Unassigned	2	IE	N/A
Oubi	OUBIV	<i>Peribunyaviridae</i>	<i>Orthobunyavirus</i>	2	A7	Olifantsvlei
Ourem	OURV	<i>Reoviridae</i>	<i>Orbivirus</i>	2	IE	Changuinola
Oxbow	OXBV	<i>Hantaviridae</i>	<i>Orthohantavirus</i>	3 ^a	A7	N/A
Pacora	PCAV	<i>Unclassified Bunyvirales</i>		2	S	N/A
Pacui	PACV	<i>Peribunyaviridae</i>	Unassigned	2	S	N/A
Pahayokee	PAHV	<i>Peribunyaviridae</i>	<i>Orthobunyavirus</i>	2	S	Patois
Palma	PMAV	<i>Phenuiviridae</i>	<i>Phlebovirus</i>	2	IE	Bhanja
Palestina	PLSV	<i>Peribunyaviridae</i>	<i>Orthobunyavirus</i>	2	IE	Minatitlan
Palyam	PALV	<i>Reoviridae</i>	<i>Orbivirus</i>	2	S	Palyam
Para	PARAV	<i>Peribunyaviridae</i>	Unassigned	2	IE	Simbu
Paramushir	PMRV	<i>Nairoviridae</i>	<i>Orthonairovirus</i>	2	IE	Sakhalin
Paraná	PARV	<i>Arenaviridae</i>	<i>Mammarenavirus</i>	2	A5	Tacaribe
Paranoá	PARV	<i>Hantaviridae</i>	<i>Orthohantavirus</i>	3 ^a	IE	N/A
Paroo River	PRV	<i>Reoviridae</i>	<i>Orbivirus</i>	2	IE	N/A
Parry's Lagoon	PLV	<i>Reoviridae</i>	<i>Orbivirus</i>	2	IE	N/A
Pata	PATAV	<i>Reoviridae</i>	<i>Orbivirus</i>	2	S	N/A
Pathum Thani	PTHV	<i>Nairoviridae</i>	<i>Orthonairovirus</i>	2	S	Dera Ghazi Khan
Patois	PATV	<i>Peribunyaviridae</i>	<i>Orthobunyavirus</i>	2	S	Patois
Peaton	PEAV	<i>Peribunyaviridae</i>	<i>Orthobunyavirus</i>	2	A1	Simbu
Perdões	N/A	<i>Peribunyaviridae</i>	<i>Orthobunyavirus</i>	2	A7	N/A

Continued on next page ►

Virus Name	Acronym	Family	Genus	Recommended BSL	Basis of Rating	Antigenic Group
Pergamino	PRGV	<i>Hantaviridae</i>	<i>Orthohantavirus</i>	3*	IE	N/A
Perinet	PERV	<i>Rhabdoviridae</i>	<i>Vesiculovirus</i>	2	A7	Vesicular Stomatitis
Peruvian horse sickness	PHSV	<i>Reoviridae</i>	<i>Orbivirus</i>	3	A1	N/A
Petevo	PETV	<i>Reoviridae</i>	<i>Orbivirus</i>	2	A7	Palyam
Phnom Penh bat	PPBV	<i>Flaviviridae</i>	<i>Flavivirus</i>	2	S	N/A
Pichindé	PICHV	<i>Arenaviridae</i>	<i>Mammarenavirus</i>	2	A5	Tacaribe
Picola	PIAV	<i>Reoviridae</i>	<i>Orbivirus</i>	2	IE	Wongorr
Pintupo	NIA	<i>Peribunyaviridae</i>	<i>Orthobunyavirus</i>	2	A7	N/A
Piritál	PIRV	<i>Arenaviridae</i>	<i>Mammarenavirus</i>	3	IE	N/A
Piry	PIRYV	<i>Rhabdoviridae</i>	<i>Vesiculovirus</i>	3	S	Vesicular Stomatitis
Pixuna	PIXV	<i>Togaviridae</i>	<i>Alphavirus</i>	2	S	Venezuelan equine encephalitis
Playas	PLAV	<i>Peribunyaviridae</i>	<i>Orthobunyavirus</i>	2	IE	Bunyamwera
Pongola	PGAV	<i>Peribunyaviridae</i>	<i>Orthobunyavirus</i>	2	S	Bwamba
Ponteves	PTVV	<i>Phenuiviridae</i>	<i>Phlebovirus</i>	2	A7	Uukuniemi
Poovoot	POOV	<i>Reoviridae</i>	<i>Orbivirus</i>	2	A7	N/A
Potiskum	POTV	<i>Flaviviridae</i>	<i>Flavivirus</i>	2	A7	N/A
Potosí	POTV	<i>Peribunyaviridae</i>	<i>Orthobunyavirus</i>	2	IE	Bunyamwera
Powassan	POWV	<i>Flaviviridae</i>	<i>Flavivirus</i>	3	S	N/A
Precarious Point	PPV	<i>Phenuiviridae</i>	<i>Phlebovirus</i>	2	A7	Uukuniemi
Pretoria	PREV	<i>Nairoviridae</i>	<i>Orthonairovirus</i>	2	S	Dera Ghazi Khan
Prospect Hill	PHV	<i>Hantaviridae</i>	<i>Orthohantavirus</i>	2	A8	Hantaan
Puchong	PUCV	<i>Rhabdoviridae</i>	<i>Ephemerovirus</i>	2	S	Bovine Ephemeral Fever
Pueblo Viejo	PVV	<i>Peribunyaviridae</i>	<i>Orthobunyavirus</i>	2	IE	Gamboa
Puffin Island	PIV	<i>Nairoviridae</i>	<i>Orthonairovirus</i>	2	A7	N/A
Punique	PUNV	<i>Phenuiviridae</i>	<i>Phlebovirus</i>	2	A7	Sandfly Fever Naples
Punta Salinas	PSV	<i>Nairoviridae</i>	<i>Orthonairovirus</i>	2	S	Hughes
Punta Toro	PTV	<i>Phenuiviridae</i>	<i>Phlebovirus</i>	2	S	Phlebotomus Fever
Purus	PURV	<i>Reoviridae</i>	<i>Orbivirus</i>	2	IE	Changuinola
Puumala	PUUV	<i>Hantaviridae</i>	<i>Orthohantavirus</i>	3*	IE	Hantaan
Qalyub	QYBV	<i>Nairoviridae</i>	<i>Orthonairovirus</i>	2	S	Qalyub
Quaranfil	QRFV	<i>Orthomyxoviridae</i>	<i>Quarantavirus</i>	2	S	Quaranfil
Quezon	QZNV	<i>Hantaviridae</i>	<i>Orthohantavirus</i>	3*	IE	N/A
Radi	RADIV	<i>Rhabdoviridae</i>	<i>Vesiculovirus</i>	2	A7	Vesicular Stomatitis
Ravn	RAVV	<i>Filoviridae</i>	<i>Marburgvirus</i>	4	S	Marburg
Raza	RAZAV	<i>Nairoviridae</i>	<i>Orthonairovirus</i>	2	A7	N/A
Razdan	RAZV	<i>Phenuiviridae</i>	Unassigned	2	IE	N/A
Resistencia	RTAV	<i>Unclassified Bunyvirales</i>		2	IE	Antequera
Restan	RESV	<i>Peribunyaviridae</i>	<i>Orthobunyavirus</i>	2	S	N/A
Reston	REST	<i>Filoviridae</i>	<i>Ebolavirus</i>	4	S	Ebola
Rift Valley fever	RVFV	<i>Phenuiviridae</i>	<i>Phlebovirus</i>	3*	S	Phlebotomus Fever
Rio Bravo	RBV	<i>Flaviviridae</i>	<i>Flavivirus</i>	2	S	N/A
Rio Grande	RGV	<i>Phenuiviridae</i>	<i>Phlebovirus</i>	2	S	Phlebotomus Fever
Rio Mamoré	RIOMV	<i>Hantaviridae</i>	<i>Orthohantavirus</i>	3*	A7	N/A
Rio Negro	RNV	<i>Togaviridae</i>	<i>Alphavirus</i>	3	A7	Venezuelan Equine Encephalitis
Rio Pracupi	NIA	<i>Peribunyaviridae</i>	<i>Orthobunyavirus</i>	2	A7	N/A

Continued on next page ►

Virus Name	Acronym	Family	Genus	Recommended BSL	Basis of Rating	Antigenic Group
Rio Preto da Eva	RIOPV	<i>Phenuiviridae</i>	Unassigned	2	IE	N/A
Riverside	RISV	<i>Rhabdoviridae</i>	Unassigned	2	IE	N/A
RML 105355	RMLV	<i>Phenuiviridae</i>	<i>Phlebovirus</i>	2	A7	N/A
Rochambeau	RBUV	<i>Rhabdoviridae</i>	<i>Curlovirus</i>	2	IE	Rab
Rocio	ROCV	<i>Flaviviridae</i>	<i>Flavivirus</i>	3	S	N/A
Rockport	RKPV	<i>Hantaviridae</i>	<i>Orthohantavirus</i>	3*	IE	N/A
Ross River	RRV	<i>Togaviridae</i>	<i>Alphavirus</i>	2	S	Semliki Forest
Rost Island	RSTV	<i>Reoviridae</i>	<i>Orbivirus</i>	2	A7	Kemerovo
Royal Farm	RFV	<i>Flaviviridae</i>	<i>Flavivirus</i>	2	S	N/A
Rukutama	RUKV	<i>Phenuiviridae</i>	<i>Phlebovirus</i>	2	A7	N/A
Russian spring-summer encephalitis	RSSEV	<i>Flaviviridae</i>	<i>Flavivirus</i>	4	S	Tick-borne Encephalitis—FE subtype
Ryukyu	RYKV	<i>Arenaviridae</i>	<i>Mammarenavirus</i>	2	A5	N/A
Saaremaa	SAAV	<i>Hantaviridae</i>	<i>Orthohantavirus</i>	3*	IE	Hantaan
Sabiá	SABV	<i>Arenaviridae</i>	<i>Mammarenavirus</i>	4	A4	N/A
Sabo	SABOV	<i>Peribunyaviridae</i>	<i>Orthobunyavirus</i>	2	S	Simbu
Saboya	SABV	<i>Flaviviridae</i>	<i>Flavivirus</i>	2	S	N/A
Saddaguaia	SADV	<i>Phenuiviridae</i>	<i>Phlebovirus</i>	2	A7	N/A
Sagiyama	SAGV	<i>Togaviridae</i>	<i>Alphavirus</i>	2	A1	Semliki Forest
Saint-Floris	SAFV	<i>Phenuiviridae</i>	<i>Phlebovirus</i>	2	S	Phlebotomus Fever
Sakhalin	SAKV	<i>Nairoviridae</i>	<i>Orthonairovirus</i>	2	S	Sakhalin
Salanga	SGAV	<i>Poxviridae</i>	Unassigned	2	IE	SGA
Salehabad	SALV	<i>Phenuiviridae</i>	<i>Phlebovirus</i>	2	S	Phlebotomus Fever
Salmon River	SAVV	<i>Reoviridae</i>	<i>Coltivirus</i>	2	IE	Colorado Tick Fever
Salobo	SBOV	<i>Phenuiviridae</i>	<i>Phlebovirus</i>	3	IE	N/A
Sal Vieja	SVV	<i>Flaviviridae</i>	<i>Flavivirus</i>	2	A7	N/A
San Angelo	SAV	<i>Peribunyaviridae</i>	<i>Orthobunyavirus</i>	2	S	California
Sandfly fever Cyprus	N/A	<i>Phenuiviridae</i>	<i>Phlebovirus</i>	2	IE	N/A
Sandfly fever Ethiopia	N/A	<i>Phenuiviridae</i>	<i>Phlebovirus</i>	2	IE	N/A
Sandfly fever Naples	SFNV	<i>Phenuiviridae</i>	<i>Phlebovirus</i>	2	S	Phlebotomus Fever
Sandfly fever Sicilian	SFSV	<i>Phenuiviridae</i>	<i>Phlebovirus</i>	2	S	Phlebotomus Fever
Sandfly fever Turkey	SFTV	<i>Phenuiviridae</i>	<i>Phlebovirus</i>	2	IE	N/A
Sandjimba	SJAV	<i>Rhabdoviridae</i>	Unassigned	2	S	Rab
Sangassou	SANGV	<i>Hantaviridae</i>	<i>Orthohantavirus</i>	3	A7	N/A
Sango	SANV	<i>Peribunyaviridae</i>	<i>Orthobunyavirus</i>	2	S	Simbu
San Juan	SJV	<i>Peribunyaviridae</i>	<i>Orthobunyavirus</i>	2	IE	Gamboa
San Perlita	SPV	<i>Flaviviridae</i>	<i>Flavivirus</i>	2	A7	N/A
Santarem	STMV	<i>Unclassified Bunyavirales</i>	N/A	2	IE	N/A
Santa Rosa	SARV	<i>Peribunyaviridae</i>	<i>Orthobunyavirus</i>	2	IE	Bunyamwera
Sapphire II	SAPV	<i>Nairoviridae</i>	<i>Orthonairovirus</i>	2	A7	N/A
Saraca	SRAV	<i>Reoviridae</i>	<i>Orbivirus</i>	2	IE	Changuinola
Sathuperi	SATV	<i>Peribunyaviridae</i>	<i>Orthobunyavirus</i>	2	S	Simbu
Sathuvachari	SVIV	<i>Reoviridae</i>	<i>Orbivirus</i>	2	A7	N/A
Saumarez Reef	SREV	<i>Flaviviridae</i>	<i>Flavivirus</i>	2	IE	N/A
Sawgrass	SAWV	<i>Rhabdoviridae</i>	Unassigned	2	S	Sawgrass
Schmallenberg	SBV	<i>Peribunyaviridae</i>	<i>Orthobunyavirus</i>	2	A7	N/A

Continued on next page ►

Virus Name	Acronym	Family	Genus	Recommended BSL	Basis of Rating	Antigenic Group
Sebokele	SEBV	<i>Picornaviridae</i>	<i>Parechovirus</i>	2	S	N/A
Sedlec	SEDV	<i>Peribunyaviridae</i>	<i>Orthobunyavirus</i>	2	A7	N/A
Seletar	SELV	<i>Reoviridae</i>	<i>Orbivirus</i>	2	S	Kemerovo
Sembalam	SEMV	<i>Unclassified virus</i>	N/A	2	S	N/A
Semliki Forest	SFV	<i>Togaviridae</i>	<i>Alphavirus</i>	3	A2	Semliki Forest
Sena Madureira	SMV	<i>Rhabdoviridae</i>	<i>Sripuvirus</i>	2	IE	Timbo
Seoul	SEOV	<i>Hantaviridae</i>	<i>Orthohantavirus</i>	3*	IE	Hantaan
Sepik	SEPV	<i>Flaviviridae</i>	<i>Flavivirus</i>	2	IE	N/A
Serra Do Navio	SDNV	<i>Peribunyaviridae</i>	<i>Orthobunyavirus</i>	2	A7	California
Serra Norte	SRNV	<i>Phenuiviridae</i>	<i>Phlebovirus</i>	2	A7	N/A
Severe fever with thrombocytopenia syndrome	SFTSV	<i>Phenuiviridae</i>	<i>Phlebovirus</i>	3	IE	N/A
Shamonda	SHAV	<i>Peribunyaviridae</i>	<i>Orthobunyavirus</i>	2	S	Simbu
Shark River	SRV	<i>Peribunyaviridae</i>	<i>Orthobunyavirus</i>	2	S	Patois
Shiant Island	SHIV	<i>Reoviridae</i>	<i>Orbivirus</i>	2	A7	N/A
Shokwe	SHOV	<i>Peribunyaviridae</i>	<i>Orthobunyavirus</i>	2	IE	Bunyamwera
Shuni	SHUV	<i>Peribunyaviridae</i>	<i>Orthobunyavirus</i>	2	S	Simbu
Silverwater	SILV	<i>Phenuiviridae</i>	<i>Phlebovirus</i>	2	S	Kaisodi
Simbu	SIMV	<i>Peribunyaviridae</i>	<i>Orthobunyavirus</i>	2	S	Simbu
Sindbis	SINV	<i>Togaviridae</i>	<i>Alphavirus</i>	2	S	Western Equine Encephalitis
Sin Nombre	SNV	<i>Hantaviridae</i>	<i>Orthohantavirus</i>	3*	IE	Hantaan
Sixgun City	SCV	<i>Reoviridae</i>	<i>Orbivirus</i>	2	S	Kemerovo
Skinner Tank	SKTV	<i>Arenaviridae</i>	<i>Mammarenavirus</i>	2	A5	N/A
Snowshoe hare	SSHV	<i>Peribunyaviridae</i>	<i>Orthobunyavirus</i>	2	S	California
Sokoluk	SOKV	<i>Flaviviridae</i>	<i>Flavivirus</i>	2	S	N/A
Soldado	SOLV	<i>Nairoviridae</i>	<i>Orthonairovirus</i>	2	S	Hughes
Solwezi	SOLV	<i>Arenaviridae</i>	<i>Mammarenavirus</i>	3	IE	N/A
Somone	SOMV	<i>Unclassified virus</i>		3	IE	Somone
Sororoca	SORV	<i>Peribunyaviridae</i>	<i>Orthobunyavirus</i>	2	S	Bunyamwera
Souris	SOUV	<i>Arenaviridae</i>	<i>Mammarenavirus</i>	2	A5	N/A
South Bay	SBV	<i>Unclassified Bunyavirales</i>	N/A	3	IE	N/A
South River	SORV	<i>Peribunyaviridae</i>	<i>Orthobunyavirus</i>	2	A7	N/A
Spondweni	SPOV	<i>Flaviviridae</i>	<i>Flavivirus</i>	2	S	N/A
Sripur	SRIV	<i>Rhabdoviridae</i>	<i>Sripuvirus</i>	3	IE	N/A
St. Abbs Head	SAHV	<i>Phenuiviridae</i>	<i>Phlebovirus</i>	2	A7	N/A
St. Louis encephalitis	SLEV	<i>Flaviviridae</i>	<i>Flavivirus</i>	2	S	N/A
Stanfield	N/A	<i>Peribunyaviridae</i>	<i>Orthobunyavirus</i>	2	A7	N/A
Stratford	STRV	<i>Flaviviridae</i>	<i>Flavivirus</i>	2	S	N/A
Sudan	SUDV	<i>Filoviridae</i>	<i>Ebolavirus</i>	4	S	Ebola
Sunday Canyon	SCAV	<i>Phenuiviridae</i>	<i>Phlebovirus</i>	2	S	N/A
Sweetwater Branch	SWBV	<i>Rhabdoviridae</i>	<i>Tibrovirus</i>	2	IE	N/A
Tacaiuma	TCMV	<i>Peribunyaviridae</i>	<i>Orthobunyavirus</i>	2	S	Anopheles A
Tacaribe	TCRV	<i>Arenaviridae</i>	<i>Mammarenavirus</i>	2	A5	Tacaribe
Táchéng tick 1	TTV-1	<i>Nairoviridae</i>	<i>Orthonairovirus</i>	2	IE	N/A
Taggart	TAGV	<i>Nairoviridae</i>	<i>Orthonairovirus</i>	2	S	Sakhalin
Tahyfia	TAHV	<i>Peribunyaviridae</i>	<i>Orthobunyavirus</i>	2	S	California

Continued on next page ►

Virus Name	Acronym	Family	Genus	Recommended BSL	Basis of Rating	Antigenic Group
Taiassui	TAIAV	<i>Peribunyaviridae</i>	<i>Orthobunyavirus</i>	2	A7	N/A
Tai Forest	TAFV	<i>Filoviridae</i>	<i>Ebolavirus</i>	4	S	Ebola
Tamdy	TDYV	<i>Nairoviridae</i>	<i>Orthonairovirus</i>	2	IE	N/A
Tamiami	TMMV	<i>Arenaviridae</i>	<i>Mammarenavirus</i>	2	A5	Tacaribe
Tanga	TANV	<i>Unclassified Bunyvirales</i>	N/A	2	S	Tanga
Tanjong Rabok	TRV	<i>Peribunyaviridae</i>	<i>Orthobunyavirus</i>	2	S	Bakau
Tapara	TAPV	<i>Phenuiviridae</i>	<i>Phlebovirus</i>	2	A7	N/A
Tataguine	TATV	<i>Peribunyaviridae</i>	<i>Orthobunyavirus</i>	2	S	N/A
Tehran	TEHV	<i>Phenuiviridae</i>	<i>Phlebovirus</i>	2	A7	Phlebotomus Fever
Telok Forest	TFV	<i>Peribunyaviridae</i>	<i>Orthobunyavirus</i>	2	IE	Bakau
Tembe	TMEV	<i>Reoviridae</i>	<i>Orbivirus</i>	2	S	N/A
Tembusu	TMUV	<i>Flaviviridae</i>	<i>Flavivirus</i>	2	S	N/A
Tensaw	TENV	<i>Peribunyaviridae</i>	<i>Orthobunyavirus</i>	2	S	Bunyamwera
Termeil	TERV	<i>Peribunyaviridae</i>	<i>Orthobunyavirus</i>	2	IE	N/A
Tete	TETEV	<i>Peribunyaviridae</i>	<i>Orthobunyavirus</i>	2	S	Tete
Thailand	THAIV	<i>Hantaviridae</i>	<i>Orthohantavirus</i>	3	A7	N/A
Thiafora	TFAV	<i>Nairoviridae</i>	<i>Orthonairovirus</i>	2	A7	Thiafora
Thimiri	THIV	<i>Peribunyaviridae</i>	<i>Orthobunyavirus</i>	2	S	Simbu
Thogoto	THOV	<i>Orthomyxoviridae</i>	<i>Thogotovirus</i>	2	S	Thogoto
Thormodseyjarlettur	THRV	<i>Reoviridae</i>	<i>Orbivirus</i>	2	A7	N/A
Thottapalayam	TPMV	<i>Hantaviridae</i>	<i>Orthohantavirus</i>	2	S	Hantaan
Tibrogargan	TIBV	<i>Rhabdoviridae</i>	<i>Tibrovirus</i>	2	S	Tibrogargan
Tillamook	TILLV	<i>Nairoviridae</i>	<i>Orthonairovirus</i>	2	A7	N/A
Tilligerry	TILV	<i>Reoviridae</i>	<i>Orbivirus</i>	2	IE	Eubenangee
Timbo	TIMV	<i>Rhabdoviridae</i>	Unassigned	2	S	Timbo
Timboteua	TBTV	<i>Peribunyaviridae</i>	<i>Orthobunyavirus</i>	2	A7	Guama
Tinaroo	TINV	<i>Peribunyaviridae</i>	<i>Orthobunyavirus</i>	2	IE	Simbu
Tindholmur	TDMV	<i>Reoviridae</i>	<i>Orbivirus</i>	2	A7	Kemerovo
Tlacotalpan	TLAV	<i>Peribunyaviridae</i>	<i>Orthobunyavirus</i>	2	IE	Bunyamwera
Tofla	TFLV	<i>Nairoviridae</i>	<i>Orthonairovirus</i>	2	IE	N/A
Tonate	TONV	<i>Togaviridae</i>	<i>Alphavirus</i>	3	IE	Venezuelan Equine Encephalitis
Tonto Creek	TTCV	<i>Arenaviridae</i>	<i>Mammarenavirus</i>	2	A5	N/A
Topografov	TOPV	<i>Hantaviridae</i>	<i>Orthohantavirus</i>	3 ^a	IE	Hantaan
Toscana	TOSV	<i>Phenuiviridae</i>	<i>Phlebovirus</i>	2	S	Phlebotomus Fever
Toure	TOUV	<i>Arenaviridae</i>	Unassigned	2	S	Tacaribe
Tracambe	TRCV	<i>Reoviridae</i>	<i>Orbivirus</i>	2	A7	N/A
Tribeč	TRBV	<i>Reoviridae</i>	<i>Orbivirus</i>	2	S	Kemerovo
Trinit	TNTV	<i>Togaviridae</i>	Unassigned	2	S	N/A
Trivittatus	TVTV	<i>Peribunyaviridae</i>	<i>Orthobunyavirus</i>	2	S	California
Trocara	TROV	<i>Togaviridae</i>	<i>Alphavirus</i>	2	IE	Trocara
Trombetas	TRMV	<i>Peribunyaviridae</i>	<i>Orthobunyavirus</i>	2	A7	N/A
Trubanaman	TRUV	<i>Peribunyaviridae</i>	<i>Orthobunyavirus</i>	2	S	Mapputta
Tsuruse	TSUV	<i>Peribunyaviridae</i>	<i>Orthobunyavirus</i>	2	S	Tete
Tucunduba	TUCV	<i>Peribunyaviridae</i>	<i>Orthobunyavirus</i>	2	A7	N/A
Tucurui	TUCRV	<i>Peribunyaviridae</i>	<i>Orthobunyavirus</i>	2	A7	N/A
Tula	TULV	<i>Hantaviridae</i>	<i>Orthohantavirus</i>	2 ^a	A8	N/A

Continued on next page ►

Virus Name	Acronym	Family	Genus	Recommended BSL	Basis of Rating	Antigenic Group
Tunari	TUNV	<i>Hantaviridae</i>	<i>Orthohantavirus</i>	3a	A7	N/A
Tunis	TUNV	<i>Phenuiviridae</i>	<i>Phlebovirus</i>	2	A7	Phlebotomus Fever
Turlock	TURV	<i>Peribunyaviridae</i>	<i>Orthobunyavirus</i>	2	S	Turlock
Turuna	TUAV	<i>Phenuiviridae</i>	<i>Phlebovirus</i>	2	IE	Phlebotomus Fever
Tyulek	TLKV	<i>Orthomyxoviridae</i>	<i>Quarantivirus</i>	2	A7	N/A
Tyulenyi	TYUV	<i>Flaviviridae</i>	<i>Flavivirus</i>	2	S	N/A
Uganda S	UGSV	<i>Flaviviridae</i>	<i>Flavivirus</i>	2	S	N/A
Umatilla	UMAV	<i>Reoviridae</i>	<i>Orbivirus</i>	2	S	Umatilla
Umbre	UMBV	<i>Peribunyaviridae</i>	<i>Orthobunyavirus</i>	2	S	Turlock
Una	UNAV	<i>Togaviridae</i>	<i>Alphavirus</i>	2	S	Semliki Forest
Upolu	UPOV	<i>Orthomyxoviridae</i>	<i>Thogotovirus</i>	2	S	Upolu
Uriurana	UURV	<i>Phenuiviridae</i>	<i>Phlebovirus</i>	2	A7	Phlebotomus Fever
Urucuri	URUV	<i>Phenuiviridae</i>	<i>Phlebovirus</i>	2	S	Phlebotomus Fever
Usutu	USUV	<i>Flaviviridae</i>	<i>Flavivirus</i>	2	S	N/A
Utinga	UTIV	<i>Peribunyaviridae</i>	<i>Orthobunyavirus</i>	2	IE	Simbu
Utive	UVV	<i>Peribunyaviridae</i>	<i>Orthobunyavirus</i>	2	A7	N/A
Uukuniemi	UUKV	<i>Phenuiviridae</i>	<i>Phlebovirus</i>	2	S	Uukuniemi
Uzun-Agach	UZAV	<i>Nairoviridae</i>	<i>Orthonairovirus</i>	2	A7	N/A
Vaeroy	VAEV	<i>Reoviridae</i>	<i>Orbivirus</i>	2	A7	N/A
Vellore	VELV	<i>Reoviridae</i>	<i>Orbivirus</i>	2	S	Palyam
Venezuelan equine encephalitis	VEEV	<i>Togaviridae</i>	<i>Alphavirus</i>	3 ^a	S	Venezuelan Equine Encephalitis
Venkatapuram	VKTV	<i>Unclassified virus</i>	N/A	2	S	N/A
Vesicular stomatitis—Alagoas	VSAV	<i>Rhabdoviridae</i>	<i>Vesiculovirus</i>	2 ^a	S	Vesicular Stomatitis
Vesicular stomatitis—Indiana	VSIV	<i>Rhabdoviridae</i>	<i>Vesiculovirus</i>	2 ^a	A3	Vesicular Stomatitis
Vesicular stomatitis—New Jersey	VSJV	<i>Rhabdoviridae</i>	<i>Vesiculovirus</i>	2 ^a	A3	Vesicular Stomatitis
Vinces	VINV	<i>Peribunyaviridae</i>	<i>Orthobunyavirus</i>	2	A7	N/A
Vinegar Hill	VHV	<i>Nairoviridae</i>	<i>Orthonairovirus</i>	2	A7	N/A
Virgin River	VRV	<i>Peribunyaviridae</i>	<i>Orthobunyavirus</i>	2	A7	N/A
Wad Medani	WMV	<i>Reoviridae</i>	<i>Orbivirus</i>	2	S	Kemerovo
Wallal	WALV	<i>Reoviridae</i>	<i>Orbivirus</i>	2	S	Wallal
Wanowrie	WANV	<i>Unclassified Bunyavirales</i>	N/A	2	S	N/A
Warrego	WARV	<i>Reoviridae</i>	<i>Orbivirus</i>	2	S	Warrego
Warrego K	WARKV	<i>Reoviridae</i>	<i>Orbivirus</i>	2	A7	N/A
Weldona	WELV	<i>Peribunyaviridae</i>	<i>Orthobunyavirus</i>	2	A7	N/A
Wēnzhōu	WENV	<i>Arenaviridae</i>	<i>Mammarenavirus</i>	3	IE	N/A
Wēnzhōu tick	WTV	<i>Nairoviridae</i>	<i>Orthonairovirus</i>	2	A7	N/A
Wesselsbron	WESSV	<i>Flaviviridae</i>	<i>Flavivirus</i>	3 ^a	S	N/A
Western equine encephalitis	WEEV	<i>Togaviridae</i>	<i>Alphavirus</i>	3	S	Western Equine Encephalitis
West Nile	WNV	<i>Flaviviridae</i>	<i>Flavivirus</i>	2	S	N/A
Wexford	WEXV	<i>Reoviridae</i>	<i>Orbivirus</i>	2	A7	N/A
Whataroa	WHAV	<i>Togaviridae</i>	<i>Alphavirus</i>	2	S	Western Equine Encephalitis
Whitewater Arroyo	WWAV	<i>Arenaviridae</i>	<i>Mammarenavirus</i>	3	IE	Tacaribe
Witwatersrand	WITV	<i>Peribunyaviridae</i>	<i>Orthobunyavirus</i>	2	S	N/A

Continued on next page ►

Virus Name	Acronym	Family	Genus	Recommended BSL	Basis of Rating	Antigenic Group
Wolkberg	WBV	<i>Peribunyaviridae</i>	<i>Orthobunyavirus</i>	2	IE	N/A
Wongal	WONV	<i>Peribunyaviridae</i>	<i>Orthobunyavirus</i>	2	S	Koongol
Wongorr	WGRV	<i>Reoviridae</i>	<i>Orbivirus</i>	2	S	Wongorr
Wyeomyia	WYOV	<i>Peribunyaviridae</i>	<i>Orthobunyavirus</i>	2	S	Bunyamwera
Xiburema	XIBV	<i>Rhabdoviridae</i>	Unassigned	2	IE	N/A
Xingu	XINV	<i>Peribunyaviridae</i>	<i>Orthobunyavirus</i>	3	N/A	Bunyamwera
Yaba-1	Y1V	<i>Peribunyaviridae</i>	<i>Orthobunyavirus</i>	2	A7	N/A
Yaba-7	Y7V	<i>Peribunyaviridae</i>	<i>Orthobunyavirus</i>	3	IE	N/A
Yacaaba	YACV	<i>Peribunyaviridae</i>	<i>Orthobunyavirus</i>	2	IE	N/A
Yakeshi	YKSV	<i>Hantaviridae</i>	<i>Orthohantavirus</i>	3 ^a	IE	N/A
Yaoundé	YAOV	<i>Flaviviridae</i>	<i>Flavivirus</i>	2	A7	N/A
Yaquina Head	YHV	<i>Reoviridae</i>	<i>Orbivirus</i>	2	S	Kemerovo
Yata	YATAV	<i>Rhabdoviridae</i>	<i>Ephemerovirus</i>	2	S	N/A
Yellow fever	YFV	<i>Flaviviridae</i>	<i>Flavivirus</i>	3	S	N/A
Yogue	YOGV	<i>Nairoviridae</i>	<i>Orthonairovirus</i>	2	S	Yogue
Yoka	YOKAV	<i>Poxviridae</i>	Unassigned	2	IE	N/A
Yokose	YOKV	<i>Flaviviridae</i>	<i>Flavivirus</i>	2	A7	N/A
Yug Bogdanovac	YBV	<i>Rhabdoviridae</i>	<i>Vesiculovirus</i>	2	IE	Vesicular Stomatitis
Yunnan orbivirus	YOUV	<i>Reoviridae</i>	<i>Orbivirus</i>	3	IE	N/A
Zaliv Terpeniya	ZTV	<i>Phenuiviridae</i>	<i>Phlebovirus</i>	2	S	Uukuniemi
Zegla	ZEGV	<i>Peribunyaviridae</i>	<i>Orthobunyavirus</i>	2	S	Patois
Zerdali	ZERV	<i>Phenuiviridae</i>	<i>Phlebovirus</i>	2	A7	Phlebotomus Fever
Zika	ZIKV	<i>Flaviviridae</i>	<i>Flavivirus</i>	2	S	N/A
Zirqa	ZIRV	<i>Nairoviridae</i>	<i>Orthonairovirus</i>	2	S	Hughes
Zungarococha	ZUNV	<i>Peribunyaviridae</i>	<i>Orthobunyavirus</i>	2	A7	N/A

*Federal regulations, import/export requirements, and taxonomic status are subject to changes. Check with the appropriate federal agency to confirm regulations and ICTV for most current taxonomic status.

- a. Containment requirements will vary based on virus concentration, animal species, or virus type. See the Hantavirus agent summary statement in [Section VIII-E](#).
- b. These organisms are considered pathogens of significant agricultural importance by APHIS (see [Appendix D](#)) and may require additional containment up to and including ABSL-3Ag containment. Not all strains of each organism are necessarily of concern to APHIS. Contact APHIS for more information regarding exact containment/permit requirements before initiating work.
- c. Garissa virus is considered an isolate of this virus, so same containment requirements apply.

Table 4. Alphabetic Listing of Arboviruses and Hemorrhagic Fever Viruses*

Virus Name	Acronym	Family	Genus	Recommended Biosafety Level	Basis of Rating	Isolate
Aedes aegypti densovirus	AaeDNV	Parvoviridae	Brevidensovirus	2	IE	Yes
Aedes albopictus densovirus	AalDNV	Parvoviridae	Brevidensovirus	2	IE	Yes
Aedes cinereus flavivirus	AeciFV	Flaviviridae	Unassigned	2	IE	?
Aedes galloisi flavivirus	AGFV	Flaviviridae	Unassigned	2	IE	?
Aedes flavivirus	AEFV	Flaviviridae	Unassigned	2	IE	Yes
Aedes pseudoscutellaris densovirus	N/A	Parvoviridae	Brevidensovirus	2	IE	?
Aedes pseudoscutellaris reovirus	N/A	Reoviridae	Dinoviravirus	2	IE	Yes
Aedes vexans flavivirus	AeveFV	Flaviviridae	Unassigned	2	IE	?
Anopheles flavivirus	N/A	Flaviviridae	Unassigned	2	IE	?
Anopheles gambiae densovirus	AgDNV	Parvoviridae	Unassigned	2	IE	Yes
Arboretum	ABTV	Rhabdoviridae	Almendravirus	2	IE	Yes
Aripo	N/A	Flaviviridae	Unassigned	2	IE	Yes
Assam	N/A	Flaviviridae	Unassigned	2	IE	?
Badu	BADUV	Phenuiviridae	Phasivirus	2	IE	Yes
Balsa	BALV	Rhabdoviridae	Almendravirus	2	IE	Yes
Barkeedji	BJV	Flaviviridae	Unassigned	2	IE	?
Bontang Baru	BBaV	Mesoniviridae	Unassigned	2	IE	Yes
Brejaia	BRJV	Unassigned	Negevirus	2	IE	Yes
Calbertado	CLBOV	Flaviviridae	Unassigned	2	IE	?
Casuarina	CASV	Mesoniviridae	Unassigned	2	IE	Yes
Cavally	CavV	Mesoniviridae	Alphamesonivirus	2	IE	Yes
Cell Fusing Agent	CFAV	Flaviviridae	Unassigned	2	IE	Yes
Chaoyang	CHAOV	Flaviviridae	Unassigned	2	IE	Yes
Coot Bay	CBV	Rhabdoviridae	Almendravirus	2	IE	Yes
Culex flavivirus	CxFV	Flaviviridae	Unassigned	2	IE	Yes
Culex Y	N/A	Birnaviridae	Entomobimavirus	2	IE	Yes
Culex theileri flavivirus	CxthFV/ CTFV	Flaviviridae	Unassigned	2	IE	Yes
Culiseta flavivirus	CsFV	Flaviviridae	Unassigned	2	IE	Yes
Cumuto	CUMV	Bunyvirales	Goukovirus	2	IE	Yes
Czech Aedes vexans flavivirus	Czech AeveFV	Flaviviridae	Unassigned	2	IE	?
Dak Nong	DKNG	Mesoniviridae	Unassigned	2	IE	Yes
Dezidougou	DEZV	Unassigned	Negevirus	2	IE	Yes
Donggang	DONV	Flaviviridae	Unassigned	2	IE	?
Eilat	EILV	Togaviridae	Alphavirus	2	IE	Yes
Ecuador Paraiso Escondido	EPEV	Flaviviridae	Unassigned	2	IE	Yes
Espirito Santo	ESV	Birnaviridae	Unassigned	2	IE	Yes
Gouleako	GOUV	Bunyviridae	Goukovirus	2	IE	Yes
Goutanap	GANV	Unassigned	Negevirus	2	IE	Yes
Guaico Culex	GCXV	Jingmenvirus	Unassigned	2	IE	Yes
Hana	HanaV	Mesoniviridae	Unassigned	2	IE	Yes
Hanko	HANKV	Flaviviridae	Unassigned	2	IE	Yes
Herbert	HEBV	Peribunyviridae	Herbevirus	2	IE	Yes
High Island	HISLV	Reoviridae	Idnovirus	2	IE	Yes
Huángpi tick 1	HTV-1	Nairoviridae	Orthonairovirus	2	IE	?

Continued on next page ►

Virus Name	Acronym	Family	Genus	Recommended Biosafety Level	Basis of Rating	Isolate
Ilomantsi	ILOV	<i>Flaviviridae</i>	<i>Unassigned</i>	2	IE	Yes
Kamiti River	KRV	<i>Flaviviridae</i>	<i>Unassigned</i>	2	A7	Yes
Kamphaeng Phet	KPHV	<i>Mesoniviridae</i>	<i>Unassigned</i>	2	IE	Yes
Kampung Karu	KPKV	<i>Flaviviridae</i>	<i>Unassigned</i>	2	IE	Yes
Karang Sari	KSaV	<i>Mesoniviridae</i>	<i>Unassigned</i>	2	IE	Yes
Kibale	KIBV	<i>Peribunyaviridae</i>	<i>Herbevirus</i>	2	IE	Yes
Lammi	LAMV	<i>Flaviviridae</i>	<i>Unassigned</i>	2	IE	Yes
La Tina	LITV	<i>Flaviviridae</i>	<i>Unassigned</i>	2	IE	Yes
Long Island tick rhabdovirus	LITRV	<i>Rhabdoviridae</i>	<i>Unassigned</i>	2	IE	?
Long Pine Key	LPKV	<i>Flaviviridae</i>	<i>Unassigned</i>	2	IE	Yes
Loreto PeAR2612/77	LORV	<i>Unassigned</i>	<i>Negevirus</i>	2	IE	Yes
Marisma mosquito	MMV	<i>Flaviviridae</i>	<i>Unassigned</i>	2	IE	Yes
Méno	MénoV	<i>Mesoniviridae</i>	<i>Unassigned</i>	2	IE	Yes
Mercadeo	MECDV	<i>Flaviviridae</i>	<i>Unassigned</i>	2	IE	Yes
Mosquito X	MXV	<i>Birnaviridae</i>	<i>Entomobimavirus</i>	2	IE	Yes
Moumo	MoumoV	<i>Mesoniviridae</i>	<i>N/A</i>	2	IE	?
Moussa	MOUV	<i>Rhabdoviridae</i>	<i>Unassigned</i>	2	IE	Yes
Nakiwogo	NAKV	<i>Flaviviridae</i>	<i>Unassigned</i>	2	IE	Yes
Nam Dinh	NDIV	<i>Mesoniviridae</i>	<i>Alphamesonivirus</i>	2	IE	Yes
Nanay	NANV	<i>Flaviviridae</i>	<i>Unassigned</i>	2	IE	Yes
Negev	NEGV	<i>Unassigned</i>	<i>Negevirus</i>	2	IE	Yes
Ngewotan	NWTV	<i>Unassigned</i>	<i>Negevirus</i>	2	IE	Yes
Ngoye	NGOV	<i>Flaviviridae</i>	<i>Unassigned</i>	2	IE	?
Nhumirim	NHUV	<i>Flaviviridae</i>	<i>Unassigned</i>	2	IE	Yes
Nienokoue	NIEV	<i>Flaviviridae</i>	<i>Unassigned</i>	2	IE	Yes
Nounané	NOUV	<i>Flaviviridae</i>	<i>Unassigned</i>	2	IE	Yes
Nsé	NseV	<i>Mesoniviridae</i>	<i>Unassigned</i>	2	IE	Yes
Ochlerotatus caspius flavivirus	OCFV	<i>Flaviviridae</i>	<i>Unassigned</i>	2	IE	Yes
Okushiri	OKV	<i>Unassigned</i>	<i>Negevirus</i>	2	IE	Yes
Palm Creek	PCV	<i>Flaviviridae</i>	<i>Unassigned</i>	2	IE	Yes
Parramatta River	PaRV	<i>Flaviviridae</i>	<i>Unassigned</i>	2	IE	Yes
Phelbotomine-associated flavivirus	<i>N/A</i>	<i>Flaviviridae</i>	<i>Unassigned</i>	2	IE	?
Piura	PIUV	<i>Unassigned</i>	<i>Negevirus</i>	2	IE	Yes
Puerto Almendras	PTAMV	<i>Rhabdoviridae</i>	<i>Almendravirus</i>	2	IE	Yes
Quảng Binh	QBV	<i>Flaviviridae</i>	<i>Unassigned</i>	2	IE	Yes
Santana	SANV	<i>Unassigned</i>	<i>Negevirus</i>	2	IE	Yes
Sarawak	SWKV	<i>Alphatetraviridae</i>	<i>Betatetravirus</i>	2	IE	Yes
Spanish Culex flavivirus	SCxFV	<i>Flaviviridae</i>	<i>Unassigned</i>	2	IE	Yes
Spanish Ochlerotatus flavivirus	SOcFV	<i>Flaviviridae</i>	<i>Unassigned</i>	2	IE	Yes
St. Croix River	SCRV	<i>Reoviridae</i>	<i>Orbivirus</i>	2	IE	Yes
Tai	TAIV	<i>Peribunyaviridae</i>	<i>Herbevirus</i>	2	IE	Yes
Tanay	TANAV	<i>Unassigned</i>	<i>Negevirus</i>	2	IE	Yes
Wallerfield	WALV	<i>Unassigned</i>	<i>Negevirus</i>	2	IE	Yes
Wang Thong	WTV	<i>Flaviviridae</i>	<i>Unassigned</i>	2	IE	Yes
Xishuangbanna flavivirus	XFV	<i>Flaviviridae</i>	<i>Unassigned</i>	2	IE	Yes
Yamada flavivirus	YDFV	<i>Flaviviridae</i>	<i>Unassigned</i>	2	IE	Yes
Yunnan Culex flavivirus	YNCxFV	<i>Flaviviridae</i>	<i>Unassigned</i>	2	IE	Yes

Table 5. Laboratories working with the viruses at BSL-3 listed below are recommended to HEPA filter the exhaust air

Virus Name
African Horse Sickness**
African Swine Fever**
Akabane**
Cabassou
Chikungunya
Everglades
Germiston
Louping Ill
Mucambo
Oropouche
Rift Valley Fever**
Rocio
Tonate
Venezuelan Equine Encephalitis
Wesselsbron**
Yellow Fever

** These organisms are considered pathogens of significant agricultural importance by the USDA (see [Appendix D](#)) and may require additional containment (up to and including ABSL-3Ag containment). Not all strains of each organism are necessarily of concern to the USDA. Contact USDA for more information regarding exact containment/permit requirements before initiating work.

References

1. American Committee on Arthropod-Borne Viruses. Information Exchange Subcommittee; American Society of Tropical Medicine and Hygiene. International catalogue of arboviruses: including certain other viruses of vertebrates. Vol 2. 3rd ed. Karabatsos N, editor. San Antonio (TX): American Society of Tropical Medicine and Hygiene; 1985.
2. Laboratory safety for arboviruses and certain other viruses of vertebrates. The Subcommittee on Arbovirus Laboratory Safety of the American Committee on Arthropod-Borne Viruses. *Am J Trop Med Hyg.* 1980;29(6):1359–81.
3. Stobart CC, Moore ML. RNA virus reverse genetics and vaccine design. *Viruses.* 2014;6(7):2531–50.
4. Lemire, KA, Rodriguez YY, McIntosh MT. Alkaline hydrolysis to remove potentially infectious viral RNA contaminants from DNA. *Virology.* 2016;13:88.
5. Calisher CH, Higgs S. The Discovery of Arthropod-Specific Viruses in Hematophagous Arthropods: An Open Door to Understanding the Mechanisms of Arbovirus and Arthropod Evolution?. *Annu Rev Entomol.* 2018;63:87–103.
6. Mary Ann Liebert, Inc. [Internet]. New Rochelle (NY): A project of The American Committee of Medical Entomology of the American Society of Tropical Medicine and Hygiene; c2019 [cited 2019 Mar 13]. Arthropod Containment Guidelines, Version 3.2. Available from: <https://www.liebertpub.com/doi/10.1089/vbz.2018.2431>
7. Bartelloni PJ, McKinney RW, Duffy TP, Cole FE Jr. An inactivated eastern equine encephalomyelitis vaccine propagated in chick-embryo cell culture. II. Clinical and serologic responses in man. *Am J Trop Med Hyg.* 1970;19(1):123–6.
8. Pittman PR, Makuch RS, Mangiafico JA, Cannon TL, Gibbs PH, Peters CJ. Long-term duration of detectable neutralizing antibodies after administration of live-attenuated VEE vaccine and following booster vaccination with inactivated VEE vaccine. *Vaccine.* 1996;14(4):337–43.
9. Bartelloni PJ, McKinney RW, Calia FM, Ramsburg HH, Cole FE Jr. Inactivated western equine encephalomyelitis vaccine propagated in chick embryo cell culture. Clinical and serological evaluation in man. *Am J Trop Med Hyg.* 1971;20(1):146–9.
10. Leifer E, Gocke DJ, Bourne H. Lassa fever, a new virus disease of man from West Africa. II. Report of a laboratory-acquired infection treated with plasma from a person recently recovered from the disease. *Am J Trop Med Hyg.* 1970;19(4):667–9.

11. Weissenbacher MC, Grela ME, Sabattini MS, Maiztequi JI, Coto CE, Frigerio MJ, et al. Inapparent infections with Junin virus among laboratory workers. *J Infect Dis.* 1978;137(3):309–13.
12. Ad Hoc Committee on the Safe Shipment and Handling of Etiologic Agents; Center for Disease Control. Classification of etiologic agents on the basis of hazard. 4th ed. U.S. Department of Health, Education, and Welfare, Public Health Service, Center for Disease Control, Office of Biosafety; 1974.
13. Hanson RP, Sulkin SE, Beuscher EL, Hammon WM, McKinney RW, Work TH. Arbovirus infections of laboratory workers. Extent of problem emphasizes the need for more effective measures to reduce hazards. *Science.* 1967;158(3806):1283–6.
14. Karabatsos N. Supplement to international catalogue of arboviruses including certain other viruses of vertebrates. *Am J Trop Med Hyg.* 1978;27(2 Pt 2 Suppl):372–440.
15. American Committee on Arthropod Borne Viruses Subcommittee on Information Exchange; Center for Disease Control. International catalogue of arboviruses: including certain other viruses of vertebrates. Vol 75. Issue 8301. 2nd ed. Berge TO, editor. Washington (DC): Public Health Service; 1975.
16. Tabachnick WJ. Laboratory containment practices for arthropod vectors of human and animal pathogens. *Lab Anim (NY).* 2006;35(3):28–33.
17. Hunt GJ, Tabachnick WJ. Handling small arbovirus vectors safely during Biosafety Level 3 containment: *Culicoides variipennis sonorensis* (Diptera: Ceratopogonidae) and exotic bluetongue viruses. *J Med Entomol.* 1996;33(3):271–7.
18. Berglund P, Quesada-Rolander M, Putkonen P, Biberfeld G, Thorstensson R, Liljestrom P. Outcome of immunization of cynomolgus monkeys with recombinant Semliki Forest virus encoding human immunodeficiency virus type 1 envelope protein and challenge with a high dose of SHIV-4 virus. *AIDS Res Hum Retroviruses.* 1997;13(17):1487–95.
19. Davis NL, Caley IJ, Brown KW, Betts MR, Irlbeck DM, McGrath KM, et al. Vaccination of macaques against pathogenic simian immunodeficiency virus with Venezuelan equine encephalitis virus replicon particles. *J Virol.* 2000;74(1):371–8.
20. Fernandez IM, Golding H, Benaissa-Trouw BJ, de Vos NM, Harmsen M, Nottet HS, et al. Induction of HIV-1 IIIb neutralizing antibodies in BALB/c mice by a chimaeric peptide consisting of a T-helper cell epitope of Semliki Forest virus and a B-cell epitope of HIV. *Vaccine.* 1998;16(20):1936–40.

21. Notka F, Stahl-Hennig C, Dittmer U, Wolf H, Wagner R. Construction and characterization of recombinant VLPs and Semliki-Forest virus live vectors for comparative evaluation in the SHIV monkey model. *Biol Chem.* 1999;380(3):341–52.
22. Kuhn RJ, Griffin DE, Owen KE, Niesters HG, Strauss JH. Chimeric Sindbis-Ross River viruses to study interactions between alphavirus nonstructural and structural regions. *J Virol.* 1996;70(11):7900–9.
23. Schoepp RJ, Smith JF, Parker MD. Recombinant chimeric western and eastern equine encephalitis viruses as potential vaccine candidates. *Virology.* 2002;302(2):299–309.
24. Paessler S, Fayzulín RZ, Anishchenko M, Greene IP, Weaver SC, Frolov I. Recombinant Sindbis/Venezuelan equine encephalitis virus is highly attenuated and immunogenic. *J Virol.* 2003;77(17):9278–86.
25. Arroyo J, Miller CA, Catalan J, Monath TP. Yellow fever vector live-virus vaccines: West Nile virus vaccine development. *Trends Mol Med.* 2001;7(8):350–4.
26. Warne SR. The safety of work with genetically modified viruses. In: Ring CJA, Blair ED, editors. *Genetically Engineered Viruses: Development and Applications.* Oxford: BIOS Scientific Publishers; 2001. p. 255–73.
27. Monath TP, McCarthy K, Bedford P, Johnson CT, Nichols R, Yoksan S, et al. Clinical proof of principle for ChimeriVax: recombinant live, attenuated vaccines against flavivirus infections. *Vaccine.* 2002;20(7–8):1004–18.
28. Smithburn KC, Hughes TP, Burke AW, Paul JH. A neurotropic virus isolated from the blood of a native of Uganda. *Am J Trop Med Hyg.* 1940;20:471–92.
29. Melnick JL, Paul JR, Riordan JT, Barnett VH, Goldblum N, Zabin E. Isolation from human sera in Egypt of a virus apparently identical to West Nile virus. *Proc Soc Exp Biol Med.* 1951;77(4):661–5.
30. Taylor RM, Work TH, Hurlbut HS, Rizk F. A study of the ecology of West Nile virus in Egypt. *Am J Trop Med Hyg.* 1956;5(4):579–620.
31. Gerhardt R. West Nile virus in the United States (1999–2005). *J Am Anim Hosp Assoc.* 2006;42(3):170–7.
32. Centers for Disease Control and Prevention. Laboratory-acquired West Nile virus infections—United States, 2002. *MMWR Morb Mortal Wkly Rep.* 2002;51(50):1133–5.
33. Venter M, Burt FJ, Blumberg L, Fickl H, Paweska J, Swanepoel R. Cytokine induction after laboratory-acquired West Nile virus infection. *N Engl J Med.* 2009;360(12):1260–2.

34. Rusnak JM, Kortepeter MG, Hawley RJ, Anderson AO, Boudreau E, Eitzen E. Risk of occupationally acquired illnesses from biological threat agents in unvaccinated laboratory workers. *Biosecur Bioterror*. 2004;2(4):281–93.
35. Arrigo NC, Adams AP, Weaver SC. Evolutionary patterns of eastern equine encephalitis virus in North versus South America suggest ecological differences and taxonomic revision. *J Virol*. 2010;84(2):1014–25.
36. Morris CD. Eastern Equine Encephalitis. In: Monath TP, editor. *The Arboviruses: Epidemiology and Ecology*. Vol 3. Boca Raton: CRC Press; 1988. p. 2–20.
37. Kinney RM, Trent DW, France JK. Comparative immunological and biochemical analyses of viruses in the Venezuelan equine encephalitis complex. *J Gen Virol*. 1983;64(Pt 1):135–47.
38. Flick R, Bouloy M. Rift Valley fever virus. *Curr Mol Med*. 2005;5(8):827–34.
39. Imam IZ, Darwish MA. A preliminary report on an epidemic of Rift Valley fever (RVF) in Egypt. *J Egypt Public Health Assoc*. 1977;52(6):417–8.
40. Francis T, Magill TP. Rift valley fever: a report of three cases of laboratory infection and the experimental transmission of the disease to ferrets. *J Exp Med*. 1935;62(3):433–48.
41. Smithburn KC, Haddow AJ, Mahaffy AF, Kitchen SF. Rift valley fever; accidental infections among laboratory workers. *J Immunol*. 1949;62(2):213–27.
42. Linthicum KJ, Anyamba A, Tucker CJ, Kelley PW, Myers MF, Peters CJ. Climate and satellite indicators to forecast Rift Valley fever epidemics in Kenya. *Science*. 1999;285(5426):397–400.
43. Weaver SC. Host range, amplification and arboviral disease emergence. *Arch Virol Suppl*. 2005;(19):33–44.

Section VIII-G: Toxin Agents

Botulinum Neurotoxin

Seven immunologically distinct serotypes of botulinum neurotoxin (BoNT) have been isolated (A, B, C1, D, E, F, and G), which are defined by neutralization of toxicity using specific homologous polyclonal antibodies. Recently, two novel BoNT have been proposed as new serotypes, but additional validation is needed to confirm these toxins as distinct types. Each BoNT holotoxin is a disulfide-bonded heterodimer, composed of a zinc metalloprotease *light chain* (approximately 50 kDa) and a *heavy chain* (approximately 100 kDa), which binds with high affinity to peripheral cholinergic nerve terminals and facilitates the translocation of the catalytic light chain into the nerve terminal cytosol.^{1,2} BoNT-mediated toxicity (i.e., muscle weakness and autonomic dysfunction) results from the activity of the light chain, which cleaves soluble N-ethylmaleimide-sensitive factor attachment protein receptor (SNARE) proteins, required for neurotransmitter release. BoNTs are produced by *Clostridium botulinum* and rare strains of *Clostridium baratii*, *Clostridium butyricum*, and *Clostridium argentinense* as protein complexes, with one to six accessory neurotoxin-associated proteins that stabilize the toxin in biological systems and facilitate its absorption from the gastrointestinal tract, making BoNT highly toxic by the oral route.¹

Serotypes A, B, E and, less commonly, F are responsible for most human poisoning through contaminated food, wound infection, or colonization of the gastrointestinal tract. Wild animals and livestock may be at greater risk for poisoning with serotypes B, C1, and D.^{3,4} To date, no confirmed cases of human or animal intoxication have been reported with serotype G. It is important to recognize that all BoNT serotypes are potentially lethal by injection, aerosol delivery, and oral ingestion. BoNT is one of the most toxic proteins known; absorption of extremely small amounts of toxin can cause severe incapacitation and death, depending upon the serotype and the route of exposure.^{5,6}

Diagnosis of Laboratory Exposures

Botulism is initially diagnosed by the presence of characteristic clinical signs and symptoms, which are similar for all serotypes and routes of intoxication.⁷ The onset of botulism is generally preceded by a latency of several hours to days, even with aerosol exposure. The duration of the latent period varies inversely with the amount of toxin absorbed.

Botulism generally begins with bilateral, symmetric cranial nerve palsies that may progress to descending flaccid paralysis, including respiratory failure. Signs and symptoms generally include dysphagia, facial paralysis, ptosis, dysarthria, diplopia, and impaired gag reflex. Asymmetric cranial nerve palsies are rarely reported.⁸

Sophisticated tests, such as nerve conduction studies and single-fiber electromyography, can support the diagnosis of botulism and distinguish it from other neuromuscular conditions presenting with similar symptoms, such as Guillain-Barré Syndrome or myasthenia gravis.⁷ Detection of BoNT in clinical or food specimens confirms clinically diagnosed cases. Laboratory tests such as mouse bioassay and mass spectrometry should be used mainly for confirmation of the clinical diagnosis, not as a basis for initiating treatment with antitoxin. Since individual variations in the presentation of signs have been documented, botulism should be suspected after a potential exposure even if some of the characteristic signs are absent.

Laboratory Safety and Containment Recommendations

Solutions of sodium hypochlorite (NaOCl, 0.1%) or sodium hydroxide (NaOH, 0.1N) readily inactivate BoNT and are recommended for decontamination of work surfaces and for spills. Sodium hypochlorite (0.6%) also inactivates cells and spores of BoNT-producing species of *Clostridium*. Sterilization in a steam autoclave at 121 °C for 30 minutes effectively inactivates BoNT and BoNT-producing species of *Clostridium*, including spores. Additional considerations for the safe use and inactivation of toxins of biological origin are found in [Appendix I](#). Because BoNT-producing species of *Clostridium* require an anaerobic environment for growth and are essentially not transmissible among individuals, exposure to pre-formed BoNT is the primary concern for laboratory workers. Two of the most significant hazards in working with BoNT and cultures of BoNT-producing species of *Clostridium* are unintentional aerosol generation, especially during centrifugation, and accidental needlestick. Although BoNT does not penetrate intact skin, the toxin can be absorbed through broken or lacerated skin as well as by contact with eyes and mucous membranes.

BSL-2 practices, containment equipment, and facilities including the use of appropriate PPE (i.e., disposable gloves, laboratory coat, and eye protection) are recommended for routine dilutions, titrations, or diagnostic studies with materials known to contain or have the potential to contain BoNT. Activities that may generate aerosols should be performed within a BSC (Class II). Needlesticks can be minimized by careful arrangement of the workspace and maintaining operational awareness at all times. Additional primary containment and personnel precautions, such as those recommended for BSL-3, should be considered on a case-by-case basis for activities that require handling of large quantities of toxin.

Workers in diagnostic laboratories should be aware that BoNT-producing species of *Clostridium* could be stable for weeks or longer in a variety of food products, clinical samples (e.g., feces), and environmental samples (e.g., soil). Stability of the toxin itself will depend upon the sterility, temperature, pH, and ionic strength of the sample matrix.^{4,9,10} BoNT retains its activity for long periods (at least 6–12

months) in a variety of frozen foods, especially under acidic conditions (pH 4.5–5.0) and/or high ionic strength, but the toxin is readily inactivated by heating at 100°C for ten minutes.¹⁰

A documented incident of laboratory intoxication with BoNT occurred in workers who were performing necropsies on animals that had been exposed 24 hours earlier to aerosolized BoNT serotype A. The laboratory workers presumably inhaled aerosols generated from the animal fur; the report does not describe protective precautions. The intoxications were relatively mild, and all affected individuals recovered after a week of hospitalization.¹¹ Despite the low incidence of laboratory-associated botulism, the high toxicity of BoNT necessitates that laboratory workers exercise caution during all experimental procedures.

Personnel not directly involved in laboratory studies involving BoNT, such as maintenance personnel, should be discouraged from entering the laboratory when a toxin is in use, until after the work has ceased and all work surfaces have been decontaminated (see [Appendix I](#) for additional information). Purified preparations of toxin sub-units (e.g., isolated BoNT light chains or heavy chains) should be handled as if contaminated with holotoxin unless proven otherwise by toxicity bioassays. Recombinant BoNT produced in heterologous expression hosts should be considered toxic and handled with equal precautionary measures as endogenously produced BoNT.

Special Issues

Vaccines There are currently no approved vaccines for BoNT. A pentavalent (serotypes A, B, C, D, and E) botulinum toxoid vaccine was available through the CDC as an investigational new drug (IND) until 2011, but it was discontinued due to a decline in immunogenicity of some of the serotypes and an increase in occurrence of moderate local reactions. Vaccine candidates are currently in clinical trials.¹²

Treatment Hospitalization is usually required, and respiratory support may be necessary for severe botulism. In 2013, FDA approved an antitoxin designated as Botulism Antitoxin Heptavalent (A, B, C, D, E, F, G)—(Equine), BAT[®] for the treatment of botulism in adult and pediatric patients. BAT[®] is currently the only approved specific treatment for botulism and can effectively neutralize each of the seven known serotypes of BoNT. BAT[®], manufactured by Emergent BioSolutions (formally Cangene), can decrease the severity of intoxication by neutralizing BoNT that remains in the bloodstream.¹³ BAT[®] is available from the U.S. Strategic National Stockpile (SNS) and is supplied by the Office of the Assistant Secretary for Preparedness and Response (ASPR). BabyBIG[®] (Botulism Immune Globulin) is available for infant botulism through the California Infant Botulism Treatment and Prevention Program.

Select Agents and Toxins BoNT and BoNT-producing species of *Clostridium* have the potential to pose a severe threat to human health and are therefore included on the HHS list of Tier 1 Select Agents and Toxins. Entities that possess, use, store, or transfer BoNT-producing species of *Clostridium* are required to be registered with the Federal Select Agent Program (FSAP). Entities that intend to possess, use, store, or transfer quantities of BoNT above the permissible amount are also required to be registered with FSAP. See [Appendix F](#) for more information.

Transfer of Agent Domestic transfer or importation of BoNT-producing species of *Clostridium* or BoNT above the permissible amount require prior approval from FSAP. A DoC permit may be required for the export of these agents and toxin to another country. See [Appendix C](#) for additional information.

Staphylococcal Enterotoxins (SE)

Staphylococcal Enterotoxins (SE) are a group of closely related extracellular protein toxins of 22 to 29 kD molecular weight that are produced by distinct gene clusters found in a wide variety of *S. aureus* strains.^{14–16} SE belong to a large family of homologous pyrogenic exotoxins from staphylococci, streptococci, and mycoplasma, which are capable of causing a range of illnesses in humans through pathological amplification of the normal T-cell receptor response, cytokine/lymphokine release, immunosuppression, and endotoxic shock.^{15,17} Classic SE include five serotypes A–E (SEA, SEB, SEC, SED, and SEE, respectively), but genomic analysis has further identified and characterized previously unrecognized SE, such as serotype H (SEH), that has been linked to foodborne incidents.^{18,19}

Symptoms from SE may vary with the exposure route and dose. SEA is a common cause of severe gastroenteritis in humans.^{20–22} In cases from accidental food poisoning, it is estimated that gastric exposure to as little as 0.05–1 µg of SEA causes incapacitating illness.^{23–27} Comparative human toxicity for different serotypes of SE is largely unknown, but human volunteers exposed to 20–25 µg of SE serotype B (SEB) experienced enteritis similar to that caused by SEA.²⁸

SE are highly toxic by intravenous and inhalation routes of exposure, with lethal doses causing death in NHPs mainly due to shock and/or pulmonary edema.^{29–33} By inference from accidental exposure of laboratory workers and controlled experiments with NHPs, it is estimated that inhalation of less than 1 ng/kg can incapacitate more than 50% of exposed humans and that the inhalation LD₅₀ in humans may be as low as 20 ng/kg for SEB.³⁴

Exposure of mucous membranes to SEB in a laboratory setting or in clinical studies has been reported to cause conjunctivitis and localized cutaneous swelling, with some laboratory workers also experiencing incapacitating

gastrointestinal symptoms.^{35–37} Intradermal or dermal exposure to concentrated SE solutions or patch tests ($\geq 1\mu\text{g}/\text{cm}^2$) has resulted in erythema, induration, or dermatitis.^{36–39}

Diagnosis of Laboratory Exposures

Diagnosis of SE intoxication is based on clinical and epidemiologic features. Gastric intoxication with SE begins rapidly after exposure (generally 1 to 6 hours) and is characterized by nausea, vomiting, and abdominal cramps; it is often accompanied by diarrhea, but generally occurs without a high fever.^{23,31} At higher exposure levels, intoxication progresses to hypovolemia, dehydration, vasodilatation in the kidneys, and lethal shock.²¹ While fever is uncommon after SE ingestion, inhalation of SE commonly results in an acute febrile illness. After a latent period of 3 to 12 hours (range 1.5 to 18 hours), inhalation of SEB results in rapid onset of illness, generally characterized by high fever (range often 103° to 105°F), chills, headache, malaise, myalgia, and a non-productive cough.³⁵ Some individuals may develop retrosternal chest pain and dyspnea. Severe cases may develop pulmonary edema or acute respiratory distress syndrome (ARDS). Inhalational SEB intoxication may also be associated with upper respiratory tract signs and symptoms (e.g., sore throat, rhinorrhea, sinus congestion, and/or profuse postnasal drip), conjunctival injection, and/or pharyngeal erythema.^{35,37} GI symptoms may also occur after SEB inhalation. Symptoms from SE ingestion usually resolve in 24 to 48 hours, and it is rarely fatal. Symptoms from SEB inhalation due to laboratory exposures generally persist for a duration of 2 to 5 days, but the cough may persist for up to four weeks.⁴⁰ Nonspecific laboratory findings in inhalational SEB include a neutrophilic leukocytosis. WBC counts are often $>10,000$ cells/ mm^3 and have ranged from 8,000 to 28,000 cells/ mm^3 . The chest X-ray is often normal but may show abnormalities consistent with pulmonary edema in severe cases.⁴⁰

Differential diagnosis of SE inhalation may be unclear initially because the symptoms are similar to disease caused by several respiratory pathogens (e.g., influenza, adenovirus, and mycoplasma). However, naturally occurring pneumonia or influenza typically involve symptoms presenting over a more prolonged interval of time, whereas SE intoxication tends to involve symptoms that rapidly plateau. Unrecognized SEB exposure has often been initially misdiagnosed as community-acquired pneumonia, with SEB exposure suspected only after onset of illness in other at-risk laboratory workers within a 12-hour period.³⁴

Laboratory confirmation of intoxication includes SE detection by immunoassay of environmental and clinical samples and gene amplification to detect staphylococcal genes in environmental samples.^{24,41,42,43} SE may be undetectable in the serum at the time symptoms occur; nevertheless, a serum specimen should be drawn as early as possible after exposure. Data from animal studies suggest the presence of SE in the serum or urine is transient.⁴⁴ Respiratory secretions and

nasal swabs may demonstrate the toxin within 24 hours of inhalation exposure. Evaluation of neutralizing antibody titers in acute and convalescent sera of exposed individuals can be undertaken, but it may yield false positives resulting from pre-existing antibodies produced in response to natural SE exposure.⁴⁰

Laboratory Safety and Containment Recommendations

General considerations for the safe use and inactivation of toxins of biological origin are found in [Appendix I](#). Inhalational exposure, mucous membrane exposure (via aerosol or droplet exposure or direct contact with contaminated gloves), accidental ingestion, and parenteral inoculation are believed to be the primary hazards of SE for laboratory and animal-care personnel.^{24,27,35} SE are relatively stable, monomeric proteins, readily soluble in water, and resistant to proteolytic degradation, temperature fluctuations, and low pH conditions. The physical/chemical stability of SE suggests that additional care must be taken by laboratory workers to avoid exposure to residual toxin that may persist in the environment.

Active SE toxins may be present in clinical samples, lesion fluids, respiratory secretions, fur, or tissues of exposed animals. Additional care should be taken during cage cleaning and the necropsy of exposed animals and in the handling of clinical stool samples because SE toxins retain toxic activity throughout the digestive tract.

Accidental laboratory exposures to SEB have been reviewed.³⁵ Documented accidents included inhalation of SE aerosols generated from pressurized equipment failure and re-aerosolization of residual toxin from the fur of exposed animals. The most common cause of laboratory intoxication with SE is currently expected to result from accidental self-exposure via the mucous membranes by touching contaminated hands or gloves to the face or eyes.

BSL-2 practices, containment equipment, and facilities should be used when handling SE or potentially contaminated material. Because SE is highly active by the oral or ocular exposure route, the use of a laboratory coat, gloves, and safety glasses is mandatory when handling toxin or toxin-contaminated solutions. Frequent, careful handwashing and laboratory decontamination should be strictly enforced when working with SE. Depending upon a risk assessment of the laboratory operation, the use of a face mask and goggles may be required to avoid ocular and oropharyngeal exposure due to inadvertent touching of the face and mucous membranes with contaminated gloves. Additional primary containment and personnel precautions, such as those recommended for BSL-3 (e.g., respirator), should be considered on a case-by-case basis for activities with a high potential for aerosol or droplet production and those involving the use of large quantities of SE.

Special Issues

Vaccines No approved vaccine or specific antidote is currently available for human use, but experimental, recombinant vaccines are under development.

Select Agents and Toxins SEA, SEB, SEC, SED, and SEE are included in the HHS Select Agents and Toxins List. Entities that intend to possess, use, store or transfer quantities of SE above the permissible amount are required to be registered with FSAP. See [Appendix F](#) for more information.

Transfer of Agent Domestic transfer or importation of SE above the permissible amount requires prior approval from FSAP. A DoC permit may be required for the export of this agent to another country. See [Appendix C](#) for additional information.

Ricin

Ricin is produced in maturing seeds of the castor plant *Ricinus communis* L., which has been recognized for centuries as a highly poisonous plant for humans and livestock.⁴⁵ The castor seed contains castor oil, an important chemical feedstock for lubricants, polyamides, polyurethanes, plasticizers, and cosmetics, but also contains as much as 6% ricin and *Ricinus communis* agglutinin (w/w).⁴⁶ Thus, processing castor seed for castor oil results in a seed meal that is a crude form of ricin. Ricin belongs to a family of type 2 ribosome-inactivating proteins (RIPs) from plants, including abrin, modeccin, and viscumin, that share a similar overall structure and mechanism of action.⁴⁷ The ricin holotoxin is a disulfide-bonded heterodimer composed of an A-chain (approximately 34 kD polypeptide) and a B-chain (approximately 32 kD). The A-chain is an N-glycosidase enzyme that removes a specific adenine base from the 28S ribosomal RNA, resulting in loss of protein synthesis by inactivation of the ribosome. The B-chain is a relatively non-toxic lectin that facilitates toxin binding and internalization through interaction with glycolipids and glycoproteins that line the surface of the target cell.⁴⁵ The *Ricinus communis* agglutinin (RCA₁₂₀) is a tetramer composed of 2 A-chains and 2 B-chains that are homologous to ricin A-chain (93%) and B-chain (84%) at the protein sequence level.⁴⁸ There are monoclonal antibodies that distinguish ricin from RCA₁₂₀ and comparisons among different castor cultivars indicate ricin content exceeds that of RCA₁₂₀ by a factor of 2.5–3.⁴⁹ As isolated from the seed, ricin is composed of various glycosylated forms and isoforms.⁵⁰

Ricin is much less toxic by weight than BoNT or SE, and published case reports suggest that gastric ingestion of ricin is rarely fatal in adults, with ingestion of castor beans the common route for gastric exposure.⁵¹ Animal studies and human poisonings suggest that the effects of ricin depend upon the route of exposure, with inhalation and intravenous exposure being the most toxic. In laboratory mice, the LD₅₀ has been estimated as 3 to 5 µg/kg by inhalation, 5 µg/kg by intravenous injection, 22 µg/kg by intraperitoneal injection, 24 µg/kg by subcutaneous

injection, and 20 mg/kg by intragastric administration.⁵² Before more stringent safety precautions were introduced, workers in castor oil processing plants and nearby residents were exposed to dust from the seed meal. While there were very few reported deaths from ricin exposure, severe allergic responses including skin reactions and asthma were common.⁵³

The human lethal dose has not been established rigorously but is estimated at 5–10 µg/kg by injection, intramuscular or intravenous, and 5–10 µg/kg by inhalation.⁵⁴ The RCA₁₂₀ is considerably less toxic than ricin, with 300 times as much RCA₁₂₀ needed to kill 50% of Vero cells in a cell toxicity study.⁵⁰

Diagnosis of Laboratory Exposures

The primary diagnosis is through clinical signs and symptoms that vary greatly depending upon the route of exposure. Following inhalation exposure, symptoms may appear within eight hours and include cough, labored respiration, and fever, which may progress to respiratory distress and death.⁵⁵ Most of the pathology occurs in the upper and lower respiratory tract, including inflammation, bloody sputum, and pulmonary edema. Toxicity from ricin inhalation will progress despite treatment with antibiotics, as opposed to a treatable bacterial infection. There is no mediastinitis as seen with inhalation anthrax. Ricin patients will not plateau clinically as occurs after inhalation of SEB.

Gastric ingestion of ricin causes nausea, vomiting, diarrhea, abdominal cramps, and dehydration. Initial symptoms may appear more rapidly following gastric ingestion (1–5 hours) but generally require exposure to much higher levels of toxin compared with the inhalation route. Following injection of ricin, symptoms may appear within six hours and include nausea, vomiting, anorexia, and high fever. The site of ricin injection typically shows signs of inflammation with marked swelling and induration. One case of poisoning by ricin injection resulted in fever, vomiting, irregular blood pressure, and death by vascular collapse after a period of several days; it is unclear in this case if the toxin was deposited intramuscularly or in the bloodstream.⁵⁶

After aerosol exposure to ricin, additional supportive clinical or diagnostic features may include the following: bilateral infiltrates on chest radiographs, arterial hypoxemia, neutrophilic leukocytosis, and a bronchial aspirate rich in protein.⁵²

Numerous methods for detecting and quantifying ricin have been developed. Specific immunoassay of serum and respiratory secretions, immunohistochemical stains of tissue, or detection of the castor seed alkaloid ricinine in urine may be used to confirm a diagnosis.⁵⁷ An immuno-PCR method is able to detect pg/ml of ricin in sera and feces of intoxicated mice.⁵⁸ PCR can detect residual castor bean DNA in most ricin preparations. Likewise, ELISA, mass spectrometry techniques, and cell viability assays are amongst the most common assays used to detect

ricin from contaminated samples.⁵⁹ Ricin is an extremely immunogenic toxin, and paired acute and convalescent sera should be obtained from survivors for measurement of antibody response.

Laboratory Safety and Containment Recommendations

General considerations for the safe use and inactivation of toxins of biological origin are found in [Appendix I](#). Precautions should be extended to handling potentially contaminated clinical, diagnostic, and post-mortem samples because ricin may retain toxicity in the lesion fluids, respiratory secretions, or unfixed tissues of exposed animals.

When the ricin A-chain is separated from the B-chain and administered parenterally to animals, its toxicity is diminished by >1,000-fold compared with ricin holotoxin.⁶⁰ However, purified preparations of natural ricin A-chain or B-chain and crude extracts from castor beans should be handled as if contaminated by ricin until proven otherwise by bioassay.

Ricin is a relatively non-specific cytotoxin and irritant that should be handled in the laboratory as a non-volatile toxic chemical. Based upon animal studies, the inhalation of air-borne dust particles or small liquid droplets carrying ricin into the lungs is still considered the most dangerous route of exposure. BSL-2 practices, containment equipment, and facilities are recommended, including laboratory coat, gloves, and eye protection, when handling ricin toxin or potentially contaminated materials. A full-face respirator should be worn if there is a potential for creating a toxin aerosol. A BSC is used if there is any chance that ricin aerosols will be generated. Solutions of ricin can be inactivated by treatment with sodium hypochlorite bleach, and crude ricin powder is inactivated by autoclaving with calcium oxide (lime).

Special Issues

Vaccines No approved vaccine or specific antidote is currently available for human use, but experimental, recombinant vaccines are under development. There is at least one commercial ricin vaccine in Phase 1 clinical trials.⁶¹

Select Agents and Toxins Ricin is included in the HHS list of Select Agents and Toxins. Entities that intend to possess, use, store or transfer quantities of ricin above the permissible amount are required to be registered with FSAP. See [Appendix F](#) for more information.

Transfer of Agent Domestic transfer or importation of ricin above the permissible amount requires prior approval from FSAP. A DoC permit may be required for the export of this agent to another country. See [Appendix C](#) for additional information.

Selected Low Molecular Weight (LMW) Toxins

Low Molecular Weight (LMW) Toxins comprise a structurally and functionally diverse class of natural poisons, ranging in size from several hundred to a few thousand daltons. LMW toxins include complex organic structures and disulfide cross-linked and cyclic polypeptides. Tremendous structural diversity may occur within a particular type of LMW toxin, often resulting in incomplete toxicological or pharmacological characterization of minor isoforms. Grouping LMW toxins together has primarily been a means of distinguishing them from protein toxins with respect to key biophysical characteristics. Compared with proteins, the LMW toxins are of smaller size, which alters properties such as filtration and distribution; are generally more stable and persistent in the environment; and some compounds may exhibit poor water-solubility necessitating the use of organic solvents. These characteristics pose special challenges for safe handling, containment, and decontamination of LMW toxins within the laboratory.

The set of LMW toxins selected for discussion herein are employed routinely as laboratory reagents and/or have been designated as potential public health threats by the CDC, including: T-2 mycotoxin, produced by *Fusarium* fungi;^{62,63} saxitoxin and related paralytic shellfish poisons, produced by select marine dinoflagellates within the genus *Alexandrium*, *Gymnodinium*, and *Pyrodinium*, as well as certain freshwater cyanobacteria;⁶⁴ tetrodotoxin from a number of marine animals;⁶⁵ brevetoxins from the dinoflagellate *Karenia brevis*;⁶⁶ palytoxins from select marine coelenterates belonging to the genus *Palythoa* and from marine dinoflagellates belonging to the genus *Ostreopsis*;^{67,68} polypeptide conotoxins α -GI (includes GIA) and α -MI from the *Conus* genus of gastropod mollusks;⁶⁹ the amino acid analog domoic acid from select marine diatoms from the genus *Pseudo-nitzschia*;⁷⁰ and the monocyclic polypeptide microcystins from select freshwater cyanobacteria such as *Microcystis aeruginosa*.⁷¹

Trichothecene mycotoxins comprise a broad class of structurally complex, non-volatile sesquiterpene compounds that are potent inhibitors of protein synthesis.^{62,63} Mycotoxin exposure occurs by consumption of moldy grains, and at least one of these toxins, designated T-2, has been implicated as a potential biological warfare agent.⁶³ T-2 is a lipid-soluble molecule that can be absorbed into the body rapidly through exposed mucosal surfaces.⁷² Toxic effects are most pronounced in metabolically active target organs and include emesis, diarrhea, weight loss, nervous disorder, cardiovascular alterations, immunodepression, hemostatic derangement, bone marrow damage, skin toxicity, decreased reproductive capacity, and death.⁶³ The LD₅₀ for T-2 in laboratory animals ranges from 0.2 to 10 mg/kg, depending on the route of exposure, with aerosol toxicity estimated to be 20 to 50 times greater than parenteral exposure.⁶³ Of special note, T-2 is a potent vesicant capable of directly damaging skin or corneas. Skin lesions, including frank blisters, have been observed in animals with local, topical application of 50 to 100 ng of toxin.^{63,72}

Saxitoxin and tetrodotoxin are paralytic marine alkaloid toxins that interfere with normal function of voltage-activated sodium channels in excitable cells of heart, muscle, and neuronal tissue by blocking ion flow, causing potentially lethal paralytic shellfish poisoning and pufferfish poisoning, respectively.⁷³ Animals exposed to 1–10 µg/kg of either of these toxins by parenteral routes typically develop a rapid onset of excitability, muscle spasm, and respiratory distress; death may occur within 10–15 minutes in extreme cases from respiratory paralysis.^{64,74} Humans ingesting seafood contaminated with saxitoxin or tetrodotoxin show similar signs of toxicity, typically preceded by paresthesias of the lips, face, and extremities.^{73,75}

Brevetoxins are ladder-frame-polyether, shellfish neurotoxins produced by marine dinoflagellates that accumulate in filter-feeding mollusks and cause non-lethal human intoxications from ingestion of contaminated seafood, known as neurotoxic shellfish poisoning, or by respiratory irritation from sea spray containing the toxins.⁷³ This toxin group lowers the activation potential in voltage-activated sodium channels resulting in channel opening at normal resting membrane potentials, effectively making the sodium channel of affected nerve or muscle cells hyper-excitabile. Symptoms of human ingestion include paresthesias of the face, throat, and fingers or toes, followed by dizziness, chills, muscle pains, nausea, gastroenteritis, and clinical signs including reduced heart rate. Brevetoxin has a parenteral LD₅₀ of 200 µg/kg in mice and guinea pigs. Guinea pigs exposed to a slow infusion of brevetoxin develop fatal respiratory failure within 30 minutes of exposure to 20 µg/kg toxin.⁷⁴

Palytoxin, and related toxins such as ovatoxins, are structurally complex, articulated fatty alcohols associated with certain colonial anemones such as *Palythoa toxica* and select marine dinoflagellates of the genus *Ostreopsis*.⁶⁷ This toxin group is capable of binding and converting the essential cellular Na⁺/K⁺ pump into a non-selective cation channel.^{68,76} Palytoxin is among the most potent coronary vasoconstrictors known, killing animals within minutes by cutting off oxygen to the myocardium.⁷⁷ Symptoms in affected individuals can vary based on the route of exposure and may include rhabdomyolysis due to consumption of contaminated seafood, respiratory distress, and fever from inhalation of aerosolized toxins, and skin and ocular irritation from topical exposure.^{67,78} The LD₅₀ for intravenous administration ranges from 0.025 to 0.45 µg/kg in different species of laboratory animals.⁷⁷ Palytoxin is lethal by several parenteral routes but is about 200-fold less toxic if administered to the alimentary tract (oral or rectal) compared with intravenous administration.⁷⁷ Palytoxin causes corneal damage and can cause irreversible blindness at topically applied levels of approximately 400 ng/kg, despite extensive rinsing after ocular instillation.⁷⁷ Like brevetoxins, palytoxins cause respiratory irritation from exposure to marine aerosols when the

causative dinoflagellates are present in high numbers, but unlike brevetoxins, palytoxins are also associated with flu-like symptoms with high fever.⁷⁸

Conotoxins are polypeptides, typically 10–30 amino acids long and stabilized by distinct patterns of disulfide bonds that have been isolated from the toxic venom of marine snails and shown to be neurologically active or toxic in mammals.⁶⁹ Of the estimated >105 different polypeptides (conopeptides) present in venom of over 500 known species of *Conus*, only a few have been rigorously tested for animal toxicity. Of the isolated conotoxin subtypes that have been analyzed, at least two post-synaptic paralytic toxins, designated α -GI (includes GIA) and α -MI, have been reported to be toxic in laboratory mice with LD₅₀ values in the range of 10–100 μ g/kg depending upon the species and route of exposure. Workers should be aware that human toxicity of whole or partially fractionated *Conus* venom, as well as synthetic combinations of isolated conotoxins, may exceed that of individual components. For example, untreated cases of human poisoning with venom of *C. geographus* result in an approximately 70% fatality rate, probably as a result of the presence of mixtures of various α - and μ -conotoxins with common or synergistic biological targets.^{69,79} The α -conotoxins act as potent nicotinic antagonists, and the μ -conotoxins block the sodium channel.⁶⁹ Symptoms of envenomation depend upon the *Conus* species involved, generally occur rapidly after exposure (minutes), and range from severe pain to spreading numbness.⁸⁰ Severe intoxication results in muscle paralysis, blurred or double vision, difficulty breathing and swallowing, and respiratory or cardiovascular collapse.⁸⁰

Domoic acid is a kainic acid analog neurotoxin that causes amnesic shellfish poisoning after the consumption of contaminated seafood. Domoic acid has a high affinity for glutamate receptors in the hippocampus resulting in excitotoxicity and neuronal degeneration.⁸¹ Symptoms of exposure include vomiting, nausea, diarrhea and abdominal cramps, headache, dizziness, confusion, disorientation, short-term memory loss, motor weakness, seizures, cardiac arrhythmias, and coma with possible death in extreme cases.

Microcystins (also called cyanoginosins) are monocyclic heptapeptides composed of specific combinations of L- and D-amino acids, some with uncommon side chain structures, that are produced by various freshwater cyanobacteria.⁸² The toxins are potent inhibitors of liver protein phosphatase type 1 and are capable of causing massive hepatic hemorrhage and death.⁸² One of the more potent toxins in this family, microcystin-LR, has a parenteral LD₅₀ of 30 to 200 μ g/kg in rodents.⁷¹ Exposure to microcystin-LR causes animals to become listless and prone in the cage; death occurs in 16 to 24 hours. The toxic effects of microcystin vary depending upon the route of exposure and may include hypotension and cardiogenic shock, in addition to hepatotoxicity.^{71,83}

Diagnosis of Laboratory Exposures

LMW toxins are a diverse set of molecules with a correspondingly wide range of signs and symptoms of laboratory exposure, as discussed above for each toxin. Common symptoms can be expected for LMW toxins with common mechanisms of action. For example, several paralytic marine toxins that interfere with normal sodium channel function cause rapid paresthesias of the lips, face, and digits after ingestion. The rapid onset of illness or injury (minutes to hours) generally supports a diagnosis of chemical or LMW toxin exposure. Painful skin lesions may occur almost immediately after contact with T-2 mycotoxin, and ocular irritation or lesions will occur in minutes to hours after contact with T-2 or palytoxin.

Specific diagnosis of LMW toxins in the form of a rapid diagnostic test is not presently available in the field. Serum and urine should be collected for testing at specialized reference laboratories by methods including antigen detection, receptor-binding assays, or liquid chromatographic analyses of metabolites.

Parent compounds and metabolites of several marine and freshwater toxins, including saxitoxin, tetrodotoxin, domoic acid, brevetoxins, and microcystins are well-studied as part of routine regulation of food and water supplies.⁷³ Likewise, T-2 mycotoxin absorption and distribution in the body has been studied, and its metabolites can be detected as late as 28 days after exposure.⁶³ Marine toxins are highly stable in food and are typically not affected by cooking or freezing. Once consumed, most marine toxins are metabolized and rapidly excreted through the urine, in some cases, such as saxitoxin, tetrodotoxin, and domoic acid, within 24–72 hours.^{81,84} In contrast, freshwater microcystins bind covalently to target protein phosphatases in the liver, making analysis of clinical samples difficult even in postmortem analysis of livestock that died from suspected microcystin contamination of drinking water.⁸⁵ Clinical specimens can include blood, urine, lung, liver, and stomach contents. Few clinical tests have been validated for these toxins. Far more methods are available for the testing of environmental or food samples including a variety of screening and confirmatory techniques, depending on the toxin.

Laboratory Safety and Containment Recommendations

General considerations for the safe use and inactivation of toxins of biological origin are found in [Appendix I](#). Ingestion, parenteral inoculation, skin and eye contamination, and droplet or aerosol exposure of mucous membranes are the primary hazards to laboratory and animal care personnel. LMW toxins also can contaminate food sources or small-volume water supplies. Additionally, the T-2 mycotoxin is a potent vesicant and requires additional safety precautions to prevent contact with exposed skin or eyes. Palytoxin also is highly toxic by the ocular route of exposure.

In addition to their high toxicity, the physical and chemical stability of the LMW toxins contributes to the risks involved in handling them in the laboratory environment. Unlike many protein toxins, the LMW toxins can contaminate surfaces as a stable, dry film that may pose an essentially indefinite contact threat to laboratory workers. Special emphasis, therefore, must be placed upon proper decontamination of work surfaces and equipment.⁸⁶

When handling LMW toxins or potentially contaminated material, BSL-2 practices, containment equipment, and facilities are recommended, especially the wearing of a laboratory coat, safety glasses, and disposable gloves; the gloves must be impervious to organic solvents or other diluents employed with the toxin.

The use of respiratory protection is considered if there is potential for aerosolization of the toxin. A BSC (Class II, Type B1 or B2) or a chemical fume hood equipped with exhaust HEPA filters are also indicated for activities with a potential for aerosol, such as powder samples, and/or the use of large quantities of toxin.

For LMW toxins that are not easily decontaminated with bleach solutions, it is recommended to use pre-positioned, disposable liners for laboratory work surfaces to facilitate clean-up and decontamination.

Special Issues

Vaccines No approved vaccines are currently available for human use. Experimental therapeutics for LMW toxins have been reviewed.⁸⁷

Select Agents and Toxins Some LMW toxins are listed as Select Agents and Toxins. Entities that intend to possess, use, store or transfer quantities of regulated LMW toxins above their permissible amount are required to be registered with FSAP. See [Appendix F](#) for more information.

Transfer of Agent Domestic transfer or importation of regulated LMW toxins above their permissible amount requires prior approval from FSAP. A DoC permit may be required for the export of this agent to another country. See [Appendix C](#) for additional information.

References

1. Pirazzini M, Rossetto O, Eleopra R, Montecucco C. *Botulinum* neurotoxins: biology, pharmacology, and toxicology. *Pharmacol Rev.* 2017;69(2):200–35.
2. Simpson L. The life history of a botulinum toxin molecule. *Toxicon* 2013;68:40–59
3. Gangarosa EJ, Donadio JA, Armstrong RW, Meyer KF, Brachman PS, Dowell VR. Botulism in the United States, 1899–1969. *Am J Epidemiol.* 1971;93(2):93–101.

4. Hatheway CL. Botulism. In: Balows A, Hausler WJ, Ohashi M, Turano A, editors. *Laboratory Diagnosis of Infectious Diseases: Principles and Practice*. Vol. 1. New York: Springer-Verlag; 1988. p. 111–33.
5. Adler M, Franz DR. Toxicity of Botulinum Neurotoxin by Inhalation: Implications in Bioterrorism. In: Salem H, Katz SA, editors. *Aerobiology: The Toxicology of Airborne Pathogens and Toxins*. Cambridge: The Royal Society of Chemistry Press; 2016. p. 167–82.
6. Johnson EA, Montecucco C. Botulism. In: Engel AG, editor. *Handbook of Clinical Neurology*. Vol. 91. Elsevier; 2008. p. 333–68.
7. Shapiro RL, Hatheway C, Swerdlow DL. Botulism in the United States: a clinical and epidemiologic review. *Ann Intern Med*. 1998;129(3):221–8.
8. Filozov A, Kattan JA, Jitendranath L, Smith CG, Lúquez C, Phan QN, et al. Asymmetric Type F botulism with cranial nerve demyelination. *Emerg Infect Dis*. 2012;18(1):102–4.
9. Woolford AL, Schantz EJ, Woodburn M. Heat inactivation of botulinum toxin type A in some convenience foods after frozen storage. *J Food Sci*. 1978;43(2):622–4.
10. Siegel LS. Destruction of botulinum toxins in food and water. In: Hauschild AHW, Dodds KL. *Clostridium botulinum: Ecology and Control in Foods*. New York: Marcel Dekker; 1993. p. 323–42.
11. Holzer E. Botulismus durch inhalation. *Med Klin*. 1962;41:1735–40. German.
12. Webb RP, Smith LA. What next for vaccine development? *Expert Rev Vaccines*. 2013;12(5):481–92.
13. Yu PA, Lin NH, Mahon BE, Sobel J, Yu Y, Mody RK, et al. Safety and Improved Clinical Outcomes in Patients Treated With New Equine-Derived Heptavalent Botulinum Antitoxin. *Clin Infect Dis*. 2017;66(suppl_1):S57–S64.
14. Argudin MA, Mendoza MC, Rodicio MR. Food poisoning and *Staphylococcus aureus* Enterotoxins. *Toxins (Basel)*. 2010;2(7):1751–73.
15. Jarraud S, Peyrat MA, Lim A, Tristan A, Bes M, Mougél C, et al. egc, a highly prevalent operon of enterotoxin gene, forms a putative nursery of superantigens in *Staphylococcus aureus*. *J Immunol*. 2001;166(1):669–77. Erratum in: *J Immunol*. 2001;166(6):following 4259.
16. Llewelyn M, Cohen J. Superantigens: microbial agents that corrupt immunity. *Lancet Infect Dis*. 2002;2(3):156–62.
17. Marrack P, Kappler J. The Staphylococcal enterotoxins and their relatives. *Science*. 1990;248(4956):705–11. Erratum in: *Science*. 1990;248(4959):1066.

18. Jørgensen HJ, Mathisen T, Løvseth A, Omoe K, Qvale KS, Loncarevic S. An outbreak of staphylococcal food poisoning caused by enterotoxin H in mashed potato made with raw milk. *FEMS Microbiol Lett.* 2005;252(2):267–72.
19. Ikeda T, Tamate N, Yamaguchi K, Makino S. Mass Outbreak of Food Poisoning Disease Caused by Small Amounts of Staphylococcal Enterotoxins A and H. *Appl Environ Microbiol.* 2005;71(5):2793–5.
20. Balaban N, Rasooly A. Staphylococcal enterotoxins. *Int J Food Microbiol.* 2000;61(1):1–10.
21. Jett M, Ionin B, Das R, Neill R. The Staphylococcal Enterotoxins. In: Sussman M, editor. *Molecular Medical Microbiology*. Vol. 2. San Diego: Academic Press; 2002. p. 1089–116.
22. Pinchuk IV, Beswick EJ, Reyes VE. Staphylococcal enterotoxins. *Toxins (Basel).* 2010;2(8):2177–97.
23. Asao T, Kumeda Y, Kawai T, Shibata T, Oda H, Haruki K, et al. An extensive outbreak of staphylococcal food poisoning due to low-fat milk in Japan: estimation of enterotoxin A in the incriminated milk and powdered skim milk. *Epidemiol Infect.* 2003;130(1):33–40.
24. Bergdoll MS. Enterotoxins. In: Montie TC, Kadis S, Aji SJ, editors. *Microbial toxins: bacterial protein toxins*. Vol. 3. New York: Academic Press; 1970. p. 265–326.
25. Do Carmo LS, Cummings C, Linardi VR, Dias RS, De Souza JM, De Sena MJ, et al. A case study of a massive staphylococcal food poisoning incident. *Foodborne Pathog Dis.* 2004;1(4):241–6.
26. Evenson ML, Hinds MW, Bernstein RS, Bergdoll MS. Estimation of human dose of staphylococcal enterotoxin A from a large outbreak of staphylococcal food poisoning involving chocolate milk. *Int J Food Microbiol.* 1988;7(4):311–6.
27. Hennekinne JA, De Buyser ML, Dragacci S. *Staphylococcus aureus* and its food poisoning toxins: characterization and outbreak investigation. *FEMS Microbiol Rev.* 2012;36(4):815–36.
28. Raj HD, Bergdoll MS. Effect of enterotoxin B on human volunteers. *J Bacteriol.* 1969;98(2):833–4.
29. Finegold MJ. Interstitial pulmonary edema. An electron microscopic study of the pathology of enterotoxemia in Rhesus monkeys. *Lab Invest.* 1967;16(6):912–24.
30. Hodoval LF, Morris EL, Crawley GJ, Beisel WR. Pathogenesis of lethal shock after intravenous staphylococcal enterotoxin B in monkeys. *Appl Microbiol.* 1968;16(2):187–92.

31. Krakauer T, Stiles BG. The staphylococcal enterotoxin (SE) family: SEB and siblings. *Virulence*. 2013;4(8):759–73
32. Mattix ME, Hunt RE, Wilhelmsen CL, Johnson AJ, Baze WB. Aerosolized staphylococcal enterotoxin B-induced pulmonary lesions in Rhesus monkeys (*Macaca mulatta*). *Toxicol Pathol*. 1995;23(3):262–8.
33. Weng CF, Komisar JL, Hunt RE, Johnson AJ, Pitt ML, Ruble DL, et al. Immediate responses of leukocytes, cytokines and glucocorticoid hormones in the blood circulation of monkeys following challenge with aerosolized staphylococcal enterotoxin B. *Int Immunol*. 1997;9(12):1825–36.
34. LeClaire RD, Pitt MLM. Biological Weapons Defense: Effect Levels. In: Lindler LE, Lebeda FJ, Korch GW, editors. *Biological Weapons Defense: Infectious Diseases and Counterbioterrorism*. Totowa (NJ): Humana Press, Inc.; 2005. p. 41–61.
35. Rusnak JM, Kortepeter M, Ulrich R, Poli M, Boudreau E. Laboratory exposures to Staphylococcal enterotoxin B. *Emerg Infect Dis*. 2004;10(9):1544–9.
36. Strange P, Skov L, Lisby S, Nielsen PL, Baasgaard O. Staphylococcal enterotoxin B applied on intact normal and intact atopic skin induces dermatitis. *Arch Dermatol*. 1996;132(1):27–33.
37. Wedum AG. The Detrick experience as a guide to the probable efficacy of P4 microbiological containment facilities for studies in microbial recombinant DNA molecules. *ABSA*. 1996;1(1):7–25.
38. Rusnak JM, Kortepeter MG. Ocular and percutaneous exposures to staphylococcal enterotoxins A and B manifested as conjunctivitis with periocular swelling and gastrointestinal symptoms or localized skin lesions. *International Conference on Emerging and Infectious Diseases 2004: Program and Abstracts Book*; 2004 Feb 29–Mar 3; Atlanta, GA. 2004.
39. Scheuber PH, Golecki JR, Kickhofen B, Scheel D, Beck G, Hammer DK. Skin reactivity of unsensitized monkeys upon challenge with staphylococcal enterotoxin B: a new approach for investigating the site of toxin action. *Infect Immun*. 1985;50(3):869–76.
40. Saikh KU, Ulrich RG, Krakauer T. Staphylococcal Enterotoxin B and Related Toxins Produced by *Staphylococcus aureus* and *Streptococcus pyogenes*. In: Bozue J, Cote CK, Glass PJ, editor. *Textbooks of Military Medicine: Medical Aspects of Biological Warfare*. Fort Sam Houston (TX): Office of The Surgeon General, Borden Institute; 2018. p. 403–14.
41. Biological toxins: Staphylococcal Enterotoxin B (SEB). In: Withers MR, lead editor. *USAMRIID's Medical Management of Biological Casualties Handbook*. 8th ed. Fort Detrick (MD): U.S. Army Medical Research Institute of Infectious Diseases; 2014. p. 129–33.

42. Kadariya J, Smith TC, Thapaliya D. Staphylococcal aureus and staphylococcal food-borne disease: an ongoing challenge in public health. *Biomed Res Int.* 2014;2014:827965.
43. Aitichou M, Henkens R, Sultana AM, Ulrich RG, Ibrahim MS. Detection of *Staphylococcus aureus* enterotoxin A and B genes with PCR-EIA and a hand-held electrochemical sensor. *Mol Cell Probes.* 2004;18(6):373–7.
44. Cook E, Wang X, Robiou N, Fries BC. Measurement of staphylococcal enterotoxin B in serum and other supernatant with a capture enzyme-linked immunosorbent assay. *Clin Vaccine Immunol.* 2007;14(9):1094–101.
45. Olsnes S. The history of ricin, abrin and related toxins. *Toxicon.* 2004;44(4):361–70.
46. McKeon TA. Castor (*Ricinus communis* L.). In: McKeon TA, Hayes DG, Hildebrand DF, Weselake RJ, editors. *Industrial Oil Crops.* AOCS Press; 2016. p. 75–112.
47. Hartley MR, Lord JM. Cytotoxic ribosome-inactivating lectins from plants. *Biochim Biophys Acta.* 2004;1701(1–2):1–14.
48. Roberts LM, Lamb FI, Pappin DJ, Lord JM. The primary sequence of *Ricinus communis* agglutinin: Comparison with ricin. *J Biol Chem.* 1985;260(29):15682–6.
49. Brandon DL, McKeon TA, Patfield SA, Kong Q, He X. Analysis of castor by ELISAs that distinguish ricin and *Ricinus communis* agglutinin (RCA). *J Am Oil Chem Soc.* 2016;93(3):359–63.
50. Worbs S, Skiba M, Soderstrom M, Rapinoja ML, Zeleny R, Russman H, et al. Characterization of ricin and *R. communis* agglutinin reference materials. *Toxins (Basel).* 2015;7(12):4906–34.
51. Doan LG. Ricin: mechanism of toxicity, clinical manifestations, and vaccine development. A review. *J Toxicol Clin Toxicol.* 2004;42(2):201–8.
52. Franz DR, Jaax NK. Ricin Toxin. In: Sidell FR, Takafuji ET, Franz DR, editors. *Textbooks of Military Medicine: Medical Aspects of Chemical and Biological Warfare. The TMM Series. Part 1: Warfare, Weaponry, and the Casualty.* Washington (DC): Office of The Surgeon General at TMM Publications; 1997. p. 631–42.
53. Apen EM, Cooper WC, Horton RJM, Scheel LD. *Health Aspects of Castor Bean Dust: Review and Bibliography.* Cincinnati (OH): U.S. Department of Health, Education, and Welfare; 1967. 132 p.
54. Bradberry SM, Dickens KJ, Rice P, Griffiths GD, Vale JA. Ricin poisoning. *Toxicol Rev.* 2003;22(1):65–70.
55. Audi J, Belson M, Patel M, Schier J, Osterloh J. Ricin poisoning, a comprehensive review. *JAMA.* 2005;294(18):2342–51.

56. Knight B. Ricin—a potent homicidal poison. *Br Med J*. 1979;1(6159):350–1
57. Johnson RC, Lemire SW, Woolfitt AR, Ospina M, Preston KP, Olson CT, et al. Quantification of ricinine in rat and human urine: a biomarker for ricin exposure. *J Anal Toxicol*. 2005;29(3):149–55.
58. He X, McMahon S, Henderson TD 2nd, Griffey SM, Cheng LW. Ricin toxicokinetics and its sensitive detection in mouse sera or feces using immune-PCR. *PLoS One*. 2010;5(9):e12858.
59. Bozza WP, Tolleson WH, Rivera Rosado LA, Zhang B. Ricin detection: tracking active toxin. *Biotechnol Adv*. 2015;33(1):117–23.
60. Soler-Rodriguez AM, Uhr JW, Richardson J, Vitetta ES. The toxicity of chemically deglycosylated ricin A-chain in mice. *Int J Immunopharmacol*. 1992;14(2):281–91.
61. Pittman PR, Reisler RB, Lindsey CY, Guereña F, Rivard R, Clizbe DP, et al. Safety and immunogenicity of ricin vaccine, RVEcTM, in a Phase 1 clinical trial. *Vaccine*. 2015;33(51):7299–306.
62. Bamburg JR. Chemical and Biochemical Studies of the Trichothecene Mycotoxins. In: Rodricks, JV, editor. *Mycotoxins and Other Fungal Related Food Problems*. Vol 149. Washington (DC): American Chemical Society; 1976. p. 144–62.
63. Wannemacher RW, Wiener SL. Trichothecene Mycotoxins. In: Sidell FR, Takafuji ET, Franz DR, editors. *Textbooks of Military Medicine: Medical Aspects of Chemical and Biological Warfare. The TMM Series. Part 1: Warfare, Weaponry, and the Casualty*. Washington (DC): Office of The Surgeon General at TMM Publications; 1997. p. 655–76.
64. Schantz EJ. Chemistry and biology of saxitoxin and related toxins. *Ann N Y Acad Sci*. 1986;479:15–23.
65. Yasumoto T, Nagai H, Yasumura D, Michishita T, Endo A, Yotsu M, et al. Interspecies distribution and possible origin of tetrodotoxin. *Ann N Y Acad Sci*. 1986;479:44–51.
66. Baden DG, Mende TJ, Lichter W, Welham H. Crystallization and toxicology of T34: a major toxin from Florida's red tide organism (*Ptychodiscus brevis*). *Toxicon*. 1981;19(4):455–62.
67. Deeds JR, Schwartz MD. Human risk associated with palytoxin exposure. *Toxicon*. 2010;56(2):150–62.
68. Moore RE, Scheuer PJ. Palytoxin: a new marine toxin from a coelenterate. *Science*. 1971;172(3982):495–8.
69. Olivera BM, Cruz LJ. Conotoxins, in retrospect. *Toxicon*. 2001;39(1):7–14.

70. Lefebvre KA, Robertson A. Domoic acid and human exposure risks: A review. *Toxicon*. 2010;56(2):218–30
71. Carmichael WW. Algal toxins. In: Callow JA, editor. *Advances in botanical research*. Vol. 12. London: Academic Press; 1986. p. 47–101.
72. Bunner BL, Wannemacher RW Jr, Dinterman RE, Broski FH. Cutaneous absorption and decontamination of [³H]T-2 toxin in the rat model. *J Toxicol Environ Health*. 1989;26(4):413–23.
73. Poli MA. Foodborne Marine biotoxins. In: Miliotis MD, Bier JW, editors. *International handbook of foodborne pathogens*. New York: Marcel Dekker; 2003. p. 445–58.
74. Franz DR, LeClaire RD. Respiratory effects of brevetoxin and saxitoxin in awake guinea pigs. *Toxicon*. 1989;27(6):647–54.
75. Kao CY. Tetrodotoxin, saxitoxin and their significance in the study of excitation phenomena. *Pharmacol Rev*. 1966;18(2):997–1049.
76. Artigas P, Gadsby DC. Na⁺/K⁺-pump ligands modulate gating of palytoxin-induced ion channels. *Proc Natl Acad Sci USA*. 2003;100(2):501–5.
77. Wiles JS, Vick JA, Christensen MK. Toxicological evaluation of palytoxin in several animal species. *Toxicon*. 1974;12(4):427–33.
78. Tubaro A, Durando P, Del Favero G, Ansaldi F, Icardi G, Deeds JR, et al. Case definitions for human poisonings postulated to palytoxins exposure. *Toxicon*. 2011;57(3):478–95.
79. Cruz LJ, White J. Clinical Toxicology of Conus Snail Stings. In: Meier J, White J, editors. *Handbook of Clinical Toxicology of Animal Venoms and Poisons*. Boca Raton: CRC Press; 1995. p. 117–27.
80. McIntosh JM, Jones RM. Cone venom—from accidental stings to deliberate injection. *Toxicon*. 2001;39(10):1447–51.
81. Pulido OM. Domoic acid toxicologic pathology: A review. *Mar Drugs*. 2008;6(2):180–219.
82. Dawson RM. The toxicology of microcystins. *Toxicon*. 1998;36(7):953–62.
83. LeClaire RD, Parker GW, Franz DR. Hemodynamic and calorimetric changes induced by microcystin-LR in the rat. *J Appl Toxicol*. 1995;15(4):303–11.
84. DeGrasse S, Rivera V, Roach J, White K, Callahan J, Couture D, et al. Paralytic shellfish toxins in clinical matrices: Extension of AOAC official method 2005.06 to human urine and serum and application to a 2007 case study in Maine. *Deep-Sea Res II*. 2014;103:368–75.

85. MacKintosh RW, Dalby KN, Campbell DG, Cohen PT, Cohen P, MacKintosh C. The cyanobacterial toxin microcystin binds covalently to cysteine-273 on protein phosphatase 1. *FEBS Lett.* 1995;371(3):236–40.
86. Wannemacher RW. Procedures for inactivation and safety containment of toxins. In: *Proceedings for the symposium on agents of biological origin.* 1989; Aberdeen Proving Ground, MD. Aberdeen, Maryland: U.S. Army Chemical Research, Development and Engineering Center; 1989. p. 115–22.
87. Padle BM. Therapy and prophylaxis of inhaled biological toxins. *J Appl Toxicol.* 2003;23(3):139–70.

Section VIII-H: Prion Diseases

Transmissible spongiform encephalopathies (TSE) or prion diseases are neurodegenerative diseases, which affect humans and a variety of domestic and wild animal species.^{1–4} A central biochemical feature of prion diseases is the conversion of normal prion protein (PrP) to an abnormal, misfolded, pathogenic isoform designated PrP^{Sc} after the prototypic prion disease—scrapie. The infectious agents that transmit prion diseases are known as prions and contain no known prion-specific nucleic acids or virus-like particles. Prions are composed mainly, if not entirely, of PrP^{Sc}. They are highly resistant to inactivation by heat and chemicals and thus require special biosafety precautions. Prions are transmissible by inoculation, ingestion, or transplantation of infected tissues or homogenates. Prion infectivity is high in the brain and other central nervous system tissues and lower in lymphoid tissues including the spleen, lymph node, gut, bone marrow, and blood. A 2017 study indicates the presence of low levels of prion infectivity in the skin of sporadic Creutzfeldt-Jakob disease (sCJD) decedents.⁵

A chromosomal gene (*PRNP*) encodes PrP^C, the cellular isoform of PrP. PrP^{Sc} is derived from PrP^C by a post-translational process whereby PrP^{Sc} acquires a high beta-sheet content and a resistance to inactivation by normal disinfection processes. PrP^{Sc} is less soluble in aqueous buffers and is partially protease-resistant. As a result, when prion-containing samples are incubated with proteases such as proteinase K, PrP^{Sc} can often be distinguished from PrP^C, which is completely protease-sensitive.

Occupational Infections

Although sCJD infections have occurred in medical specialists and health professionals, including pathologists who encounter cases of CJD post-mortem, no overall increased occupational risk for health professionals has been found.⁶ However, despite the lack of a clearly identified source, the atypical pathology of CJD in at least one neurosurgeon suggests that this case was more likely to have been an acquired, rather than sporadic, form of CJD.⁷

Modes of Infection and Spread

Recognized diseases caused by prions are listed in Table 1 (human diseases) and Table 2 (animal diseases). Besides certain medical procedures using prion contaminated materials (e.g., dura matter), the only clear risk factor for natural disease transmission is the consumption of infected tissues, such as human brain in the case of Kuru, and meat, including nervous tissue, in the case of bovine spongiform encephalopathy (BSE) and related diseases such as feline spongiform encephalopathy (FSE). Familial forms of CJD are acquired by inheritance of a mutant *PRNP* gene through the germline.

Although the exact mechanism of infection and spread among sheep and goats developing natural scrapie is unknown, there is considerable evidence that one of the primary sources is oral ingestion of placental membranes from infected ewes. There is no evidence of transmission of scrapie to humans even though the disease has been recognized in sheep for over 200 years. The TSE diseases, transmissible mink encephalopathy (TME), BSE, FSE, and exotic ungulate encephalopathy (EUE), are all thought to occur after the consumption of prion-infected foods.⁸ The exact mechanism of chronic wasting disease (CWD) spread among mule deer, white-tailed deer, and Rocky Mountain elk is unknown.³ There is strong evidence that CWD is laterally transmitted and environmental contamination may play an important role in local maintenance of the disease. Under experimental conditions, CWD and other prion diseases have been transmitted via aerosols, but there is no evidence that this is a natural route of transmission.^{9–11}

Prions are usually most efficient at infecting the homologous species, but cross-species infection with a reduced efficiency is also possible. After cross-species infection, there is often a gradual adaptation of specificity for the new host, especially if there is spread from individual to individual. This process of cross-species adaptation can vary among individuals within the same species. Therefore, the rate of adaptation and final species specificity of the resultant prion is difficult to predict. Such considerations help to form the basis for the biosafety classification of different prions.

Table 1. Human Prion Diseases

Disease	Abbreviation	Mechanism of Pathogenesis
Kuru	N/A	Infection through ritualistic cannibalism
Sporadic CJD	sCJD	Unknown mechanism; possibly somatic mutation or spontaneous conversion of PrP ^c to PrP ^{sc}
Variant CJD	vCJD	Infection presumably from consumption of BSE-contaminated cattle products or secondary bloodborne transmission
Familial or genetic CJD	fCJD or gCJD	Germline mutations in <i>PRNP</i> gene
Iatrogenic CJD	iCJD	Infection from contaminated corneal or dura mater grafts, pituitary hormone, or neurosurgical equipment
Gerstmann–Sträussler–Scheinker syndrome	GSS	Germline mutations in <i>PRNP</i> gene

Continued on next page ►

Disease	Abbreviation	Mechanism of Pathogenesis
Fatal Familial Insomnia	FFI	Germline mutations in <i>PRNP</i> gene
Sporadic Fatal Insomnia	sFI	Presumably same as sCJD (see above)
Variably Protease-Sensitive Prionopathy	VPSPr	Presumably same as sCJD (see above)

Table 2. Animal Prion Diseases

Disease	Abbreviation	Natural Host	Mechanism of Pathogenesis
Scrapie	N/A	Sheep, goats, mouflon	Infection in genetically susceptible animals
Bovine Spongiform Encephalopathy	BSE	Cattle	Infection with prion-contaminated feedstuffs (classical BSE); unknown/possible spontaneous misfolding of PrP ^C to PrP ^{Sc} (atypical BSE)
Chronic Wasting Disease	CWD	Mule deer, white-tailed deer, Rocky Mountain elk, reindeer, moose	Unknown mechanism; probably from direct animal contact with infected feces, urine, drool, or indirectly from contaminated environment (e.g., feed, water, dirt)
Exotic Ungulate Encephalopathy	EUE	Nyala, greater kudu, and onyx	Infection with BSE-contaminated feedstuffs
Feline Spongiform Encephalopathy	FSE	Domestic cats, wild cats in captivity	Infection with BSE-contaminated feedstuffs
Transmissible Mink Encephalopathy	TME	Mink (farm-raised)	Infection with prion-contaminated feedstuffs

Laboratory Safety and Containment Recommendations

In the laboratory setting, prions from human tissue and human prions propagated in animals can be manipulated at BSL-2 or higher. Due to concerns about BSE prions infecting humans and cattle, certain circumstances may call for the use of BSL-3 facilities and/or practices, with a sealed secondary container used for transport of samples inside the laboratory. Use of containment and prion-dedicated equipment is recommended whenever possible in order to limit contamination as well as the area and materials that would need to undergo inactivation procedures.

All other animal prions may be manipulated at BSL-2 with standard BSL-2 practices. However, when a prion from one species is inoculated into another the resultant infected animal should be treated according to the biosafety

guidelines applying to either the source or recipient of the inoculum, whichever is more stringent.

In the care of patients diagnosed with human prion disease, Standard Precautions are considered adequate. Human prion diseases in the clinical setting have not been found to be communicable or contagious other than through invasive procedures resulting in iatrogenic exposures.¹² One study reports finding detectable infectivity and prion seeding activity in the skin of sCJD cadavers though at much lower levels than what is found in brain tissues of sCJD patients. If such infectivity were also to be found in asymptomatic prion infected persons or early in the course of the sCJD illness, this could heighten concern for the potential of iatrogenic sCJD transmission through invasive skin procedures.⁵

There is no evidence of contact or aerosol transmission of prions from one human to another. However, human prions have been transmitted via some routes. Kuru has been transmitted through ritualistic cannibalism in New Guinea. Iatrogenic CJD has been caused by the contamination of medical devices, administration of prion-contaminated growth hormone, or the transplantation of prion-contaminated dura mater and corneal grafts. It is highly suspected that variant CJD can also be transmitted by blood transfusion.¹³ However, there is no evidence for bloodborne transmission of non-variant forms of CJD.¹⁴ Familial CJD, Gerstmann–Sträussler–Scheinker syndrome (GSS), and fatal familial insomnia (FFI) are all dominantly-inherited prion diseases; many different mutations of the *PRNP* gene have been shown to be genetically linked to the development of inherited prion disease.

Studies of prions from many cases of inherited prion disease have demonstrated transmission to apes, monkeys, and mice, especially those carrying human *PRNP* transgenes.

Special Issues

Inactivation of Prions Prions are characterized by relative resistance to conventional inactivation procedures including irradiation, boiling, dry heat, and harsh chemicals such as formalin, betapropiolactone, and alcohols. While prion infectivity in purified samples is diminished by prolonged digestion with proteases, the results from boiling in sodium dodecyl sulfate (SDS) and urea alone are variable. More effective treatments include enzymatic treatments with SDS,¹⁵ vaporized hydrogen peroxide,¹⁶ 4% SDS in 1% acetic acid at 65–134°C,^{17,18} or mildly acidic hypochlorous acid.¹⁹ Denaturing organic solvents such as phenol or chaotropic reagents (e.g., guanidine isothiocyanate) have resulted in greatly reduced, but not always complete, inactivation. Similarly, the use of conventional autoclaves as the sole inactivating treatment has not always resulted in complete inactivation of prions.^{20,21} Formalin-fixed and paraffin-embedded tissues, especially of the brain, remain infectious.²² Some investigators recommend that formalin-fixed tissues from suspected cases of prion disease be immersed for 30 minutes in 96%

formic acid or phenol before histopathologic processing (see Table 3), but such treatments may severely distort the microscopic neuropathology and may not completely inactivate infectivity.

The safest and most unambiguous method for ensuring that there is no risk of residual infectivity on contaminated instruments and other materials is to discard and destroy them by incineration.²³ Current recommendations for inactivation of prions on instruments and other materials are based on the use of sodium hypochlorite, NaOH, Environ LpH (no longer commercially available),²⁴ and the moist heat of autoclaving. Combinations of heat and chemical inactivation are likely to be most reliable (See Table 4).^{20,23,25} A less caustic hypochlorous acid solution can also decontaminate prions on stainless steel,¹⁹ but further validation of this treatment is warranted.

Surgical Procedures Precautions for surgical procedures on patients diagnosed with prion disease are outlined in an infection control guideline for transmissible spongiform encephalopathies developed by a consultation convened by the WHO in 1999.^{23,25} Sterilization of reusable surgical instruments and decontamination of surfaces are performed in accordance with recommendations described by the CDC and the WHO infection control guidelines.²³ Table 4 summarizes the key recommendations for decontamination of reusable instruments and surfaces. Contaminated disposable instruments or materials can be incinerated at 1000°C (1832°F) or greater.^{26,27}

Autopsies Routine autopsies and the processing of small amounts of formalin-fixed tissues containing human prions can safely be done using Standard Precautions.^{28,29} The absence of any known effective treatment for prion disease demands caution. The highest concentrations of prions are in the central nervous system and its coverings. Based on animal studies, it is likely that prions are also found in the spleen, thymus, lymph nodes, skin, blood, and intestine. The main precaution to be taken by laboratorians working with prion-infected or contaminated material is to avoid accidental puncture of the skin.¹² If possible, cut resistant gloves are worn when handling contaminated specimens. If accidental contamination of unbroken skin occurs, the area is washed with detergent and abundant quantities of warm water (avoid scrubbing); brief exposure (1 minute to 1 N NaOH or a 1:10 dilution of bleach) or more prolonged soaking in a commercial hypochlorous acid preparation (BrioHOCl®) can be considered for additional safety.^{19,23} Additional guidance related to occupational injury is provided in the WHO infection control guidelines.²³ Unfixed samples of brain, spinal cord, and other tissues containing human prions should be processed with extreme care in a BSL-2 facility, optimally with restricted access, additional PPE, and dedicated equipment.

Bovine Spongiform Encephalopathy

Although the eventual total number of variant CJD cases resulting from BSE transmission to humans is unknown, a review of the epidemiological data from the United Kingdom indicates that BSE transmission to humans is not efficient.³⁰ The most prudent approach is to study BSE prions at a minimum in a BSL-2 facility utilizing appropriate BSL-3 practices.

When performing necropsies on large animals where there is an opportunity that the worker may be accidentally splashed or have contact with high-risk materials (e.g., spinal column, brain), personnel wear full-body coverage personal protective equipment (e.g., gloves, rear closing gown, and face shield). Use of disposable plasticware, which can be discarded as a dry regulated medical waste or incinerated, is highly recommended.

Aerosol transmission of prions has been observed experimentally,^{9–11} but there is no evidence that this occurs under natural conditions or in clinical settings. It is still prudent to avoid the generation of aerosols or droplets during the manipulation of tissues or fluids and during the necropsy of experimental animals. It is further strongly recommended that impervious gloves be worn for activities that provide the opportunity for skin contact with infectious tissues and fluids.

Animal carcasses and other tissue waste can be disposed by incineration with a minimum secondary temperature of 1000°C (1832°F).^{23,26} Pathological incinerators should maintain a primary chamber temperature in compliance with design and applicable state regulations and employ good combustion practices. Medical waste incinerators should comply with applicable state and federal regulations.

The alkaline hydrolysis process, using a vessel that exposes the carcass or tissues to NaOH or KOH heated to 95°–150°C, can be used as an alternative to incineration for the disposal of carcasses and tissue.^{20,31} The process has been shown to completely inactivate some strains of prions when used for the recommended period.

Table 3. Tissue Preparation for Human CJD and Related Diseases

Step	Instructions
1	Histology technicians wear gloves, apron, laboratory coat, and face protection.
2	Adequate fixation of small tissue samples (e.g., biopsies) from a patient with suspected prion disease can be followed by post-fixation in 96% absolute formic acid for 30 minutes, followed by 45 hours in fresh 10% formalin.
3	Liquid waste can be collected in a 4 L waste bottle initially containing 600 ml 6 N NaOH.
4	Gloves, embedding molds, and all handling materials are disposed as regulated medical waste.

Continued on next page ►

Step Instructions

- 5 Tissue cassettes can be processed in a TSE-dedicated processor or manually to prevent contamination of general use tissue processors.
-
- 6 Tissues are embedded in a disposable embedding mold. If used, forceps are decontaminated as in Table 4.
-
- 7 In preparing sections, cut-resistant gloves can be worn; section waste is collected and disposed of in a regulated medical waste receptacle. The knife stage is wiped with 2 N NaOH, or sodium hypochlorite (20,000 ppm) followed by distilled water. The knife used is discarded immediately in a "regulated medical waste sharps" receptacle. Slides are labeled with "CJD Precautions." The sectioned block is sealed with paraffin.
-
- 8 Routine staining:
- slides are processed by hand using disposable specimen cups or in a TSE-dedicated stainer;
 - after placing the coverslip on, slides are decontaminated by soaking them for 10–60 min in 2 N NaOH or sodium hypochlorite (20,000 ppm) followed by distilled water; and
 - slides are labeled as "Infectious-CJD."
-
- 9 Other suggestions:
- disposable specimen cups or slide mailers may be used for reagents;
 - slides for immunocytochemistry may be processed in disposable Petri dishes; and
 - equipment is decontaminated as described above or disposed as regulated medical waste.
-

Handling and processing of tissues from patients with suspected prion disease

The special characteristics of work with prions require attention to the facilities, equipment, policies, and procedures involved.¹⁰ The related considerations outlined in Table 3 should be incorporated into the laboratory's risk management for this work.

Handling and processing of multiple human prion tissue samples

In research environments where multiple human prion positive tissues may be processed and stained, a prion-dedicated tissue processor, self-contained stainer (i.e., discharge is collected and not discarded into the drain), dedicated specimen cups, and staining dishes can be used. The same personal protective equipment, decontamination procedures, and waste disposal procedures listed in Table 3 are also applicable. In addition, large volumes of aqueous liquid waste generated by the tissue processor and stainer can be mixed with moisture-absorbing pellets, sealed in a container, and incinerated at 1000°C (1832°F) or greater.

Table 4. Prion Inactivation Methods for Reusable Instruments and Surfaces^{19,21,24,25}

Method	Instructions
1	Immerse in 1 N NaOH or sodium hypochlorite (20,000 ppm available chlorine) for 1 hour. Transfer into water and autoclave (gravity displacement) at 121°C for 1 hour. Clean and sterilize by conventional means. [Note: Sodium hypochlorite may be corrosive to some instruments, including autoclaves.]
2	Immerse in a pan containing 1 N NaOH, heat in a gravity displacement autoclave at 121°C for 30 minutes. Clean-rinse in water and sterilize by conventional means.
3	Immerse in 1 N NaOH or sodium hypochlorite (20,000 ppm) for 1 hour. Remove and rinse instruments with water, transfer to open pan and autoclave at 121°C (gravity displacement) or 134°C (porous load) for 1 hour. Clean and sterilize by conventional means.
4	Surfaces or heat-sensitive instruments can be treated with 2 N NaOH or sodium hypochlorite (20,000 ppm) for 1 hour. Ensure surfaces remain wet for entire period, then rinse well with water. Before chemical treatment, it is strongly recommended that gross contamination of surfaces be reduced because the presence of excess organic material will reduce the strength of either NaOH or sodium hypochlorite solutions.
5	2% Environ LpH® (EPA Reg. No. 1043-118; no longer commercially available) may be used on washable, hard, non-porous surfaces (such as floors, tables, equipment, and counters), items, such as non-disposable instruments, sharps, and sharp containers, and/or laboratory waste solutions (such as formalin or other liquids). This product is currently being used under FIFRA Section 18 exemptions in a number of states. Users should consult with the state environmental protection office prior to use. Items may be immersed for 0.5–16 h, rinsed with water, and sterilized using conventional methods.

(Adapted from <https://www.cdc.gov>)

The FDA has not yet approved any product for decontaminating, disinfecting, or sterilizing prions. The methods described are considered **research use only**.

Working Solutions: 1 N NaOH equals 40 grams of NaOH per liter of water. Solution should be prepared daily. A stock solution of 10 N NaOH can be prepared and 1:10 dilutions (1 part 10 N NaOH plus 9 parts water) should be prepared frequently enough to maintain a fully effective alkalinity.

Note, 20,000 ppm sodium hypochlorite equals a 2% solution. Many commercial household bleach sources in the United States contain 6.15% sodium hypochlorite; for such sources, a 1:3 v/v dilution (1 part bleach plus 2 parts water) would produce a solution with 20,500 ppm available chlorine. This relatively easy method provides a slightly more concentrated solution (extra 500 ppm) that should not pose a problem with decontamination procedures or significantly increase chemical risks in the laboratory. Bleach solutions can off-gas and working solutions should be prepared frequently enough to maintain adequate available chlorine levels.

CAUTION: Above solutions are corrosive and require suitable personal protective equipment and proper secondary containment. These strong corrosive solutions require careful disposal in accordance with local regulations. Sodium hypochlorite and sodium hydroxide solutions may corrode autoclaves.

Precautions for using NaOH or sodium hypochlorite solutions in

autoclaves NaOH spills or gas may damage the autoclave if proper containers are not used. The use of containers with a rim and lid designed for condensation to collect and drip back into the pan is recommended. Aluminum should not be used. Persons who use this procedure should be cautious in handling hot NaOH solution (post-autoclave) and in avoiding potential exposure to gaseous NaOH; exercise caution during all sterilization steps; and allow the autoclave, instruments, and solutions to cool down before removal.^{25,32} Immersion in sodium hypochlorite bleach can cause severe damage to some instruments. Neutralization of hypochlorite with thiosulfate prior to autoclaving is recommended to prevent the release of chlorine gas.³³

Biosafety cabinet (BSC) decontamination Because the paraformaldehyde vaporization procedure does not diminish prion titers, BSCs must be decontaminated with 1 N NaOH or 50% v/v of 5.25% sodium hypochlorite household bleach and rinsed with water. BSC technicians should chemically treat the HEPA filter and chamber while removing it from its housing. HEPA filters can be wrapped in a double layer of plastic and incinerated. The use of respirators may be advisable to protect against chemical vapors during decontamination.

References

1. Will RG, Ironside JW. Sporadic and Infectious Human Prion Diseases. *Cold Spring Harb Perspect Med.* 2017;7(1).
2. Brown P, Brandel JP, Sato T, Nakamura Y, MacKenzie J, Will RG, et al. Iatrogenic Creutzfeldt-Jakob disease, final assessment. *Emerging Infect Dis.* 2012;18(6):901–7.
3. Haley NJ, Hoover EA. Chronic wasting disease of cervids: current knowledge and future perspectives. *Annu Rev Anim Biosci.* 2015;3:305–25.
4. Greenlee JJ, Greenlee MH. The transmissible spongiform encephalopathies of livestock. *ILAR J.* 2015;56(1):7–25.
5. Orru CD, Yuan J, Appleby BS, Li B, Li Y, Winner D, et al. Prion seeding activity and infectivity in skin samples from patients with sporadic Creutzfeldt-Jakob disease. *Sci Transl Med.* 2017;9(417).
6. Alcalde-Cabero E, Almazan-Isla J, Brandel JP, Breithaupt M, Catarino J, Collins S, et al. Health professions and risk of sporadic Creutzfeldt-Jakob disease, 1965 to 2010. *Euro Surveill.* 2012;17(15).

7. Kobayashi A, Parchi P, Yamada M, Brown P, Saverioni D, Matsuura Y, et al. Transmission properties of atypical Creutzfeldt-Jakob disease: a clue to disease etiology?. *J Virol.* 2015;89(7):3939–46.
8. Marin-Moreno A, Fernandez-Borges N, Espinosa JC, Androletti O, Torres JM. Transmission and Replication of Prions. *Prog Mol Biol Transl Sci.* 2017;150:181–201.
9. Denkers ND, Seelig DM, Telling GC, Hoover EA. Aerosol and nasal transmission of chronic wasting disease in cervidized mice. *J Gen Virol.* 2010;91(Pt 6):1651–8.
10. Haybaeck J, Heikenwalder M, Klevenz B, Schwarz P, Margalith I, Bridel C, et al. Aerosols transmit prions to immunocompetent and immunodeficient mice. *PLoS Pathog.* 2011;7(1):e1001257. Erratum in: Correction: Aerosols transmit prions to immunocompetent and immunodeficient mice. *PLoS Pathog.* 2016.
11. Denkers ND, Hayes-Klug J, Anderson KR, Seelig DM, Haley NJ, Dahmes SJ, et al. Aerosol Transmission of Chronic Wasting Disease in white-tailed deer. *J Virol.* 2013;87(3):1890–2.
12. Ridley RM, Baker HF. Occupational risk of Creutzfeldt-Jakob disease. *Lancet.* 199;341(8845):641–2.
13. Llewelyn CA, Hewitt PE, Knight RS, Amar K, Cousens S, Mackenzie J, et al. Possible transmission of variant Creutzfeldt-Jakob disease by blood transfusion. *Lancet.* 2004;363(9407):417–21.
14. Crowder LA, Schonberger LB, Dodd RY, Steele WR. Creutzfeldt-Jakob disease lookback study: 21 years of surveillance for transfusion transmission risk. *Transfusion.* 2017;57(8):1875–8.
15. Jackson GS, McKintosh E, Flechsig E, Prodromidou K, Hirsch P, Linehan J, et al. An enzyme-detergent method for effective prion decontamination of surgical steel. *J Gen Virol.* 2005;86(Pt 3):869–78.
16. Fichet G, Comoy E, Duval C, Antloga K, Dehen C, Charbonnier A, et al. Novel methods for disinfection of prion-contaminated medical devices. *Lancet.* 2004;364(9433):521–6.
17. Peretz D, Supattapone S, Giles K, Vergara J, Freyman Y, Lessard P, et al. Inactivation of prions by acidic sodium dodecyl sulfate. *J Virol.* 2006;80(1):322–31.
18. Giles K, Glidden DV, Beckwith R, Seoanes R, Peretz D, DeArmond SJ, et al. Resistance of bovine spongiform encephalopathy (BSE) prions to inactivation. *PLoS Pathog.* 2008;4(11):e1000206.

19. Hughson AG, Race B, Kraus A, Sangare LR, Robins L, Groveman BR, et al. Inactivation of Prions and Amyloid Seeds with Hypochlorous Acid. *PLoS Pathog.* 2016;12(9):e1005914.
20. Taylor DM, Woodgate SL. Rendering practices and inactivation of transmissible spongiform encephalopathy agents. *Rev Sci Tech.* 2003;22(1):297–310.
21. Ernst DR, Race RE. Comparative analysis of scrapie agent inactivation methods. *J Virol Methods.* 1993;41(2):193–201.
22. Priola SA, Ward AE, McCall SA, Trifilo M, Choi YP, Solfrosi L, et al. Lack of prion infectivity in fixed heart tissue from patients with Creutzfeldt-Jakob disease or amyloid heart disease. *J Virol.* 2013;87(17):9501–10.
23. Communicable Disease and Surveillance Control. WHO Infection Control Guidelines for Transmissible Spongiform Encephalopathies. Report of a WHO Consultation; 1999 Mar 23–26; Geneva, Switzerland. Geneva: World Health Organization; 1999. p. 1–38.
24. Race RE, Raymond GJ. Inactivation of transmissible spongiform encephalopathy (prion) agents by environ LpH. *J Virol.* 2004;78(4):2164–5.
25. Centers for Disease Control and Prevention [Internet]. Atlanta (GA): Division of High-Consequence Pathogens and Pathology (DHCPP); c2018 [cited 2019 Mar 5]. Creutzfeldt-Jakob Disease, Classic (CJD). *Infectious Control.* Available from: <https://www.cdc.gov/prions/CJD/infection-control.html>
26. Brown P, Rau EH, Johnson BK, Bacote AE, Gibbs CJ Jr, Gajdusek DC. New studies on the heat resistance of hamster-adapted scrapie agent: threshold survival after ashing at 600 degrees C suggests an inorganic template of replication. *Proc Natl Acad Sci U S A.* 2000;97(7):3418–21.
27. Brown P, Rau EH, Lemieux P, Johnson BK, Bacote AE, Gajdusek DC. Infectivity studies of both ash and air emissions from simulated incineration of scrapie-contaminated tissues. *Environ Sci Technol.* 2004;38(22):6155–60.
28. Ironside JW, Bell JE. The 'high-risk' neuropathological autopsy in AIDS and Creutzfeldt-Jakob disease: principles and practice. *Neuropathol Appl Neurobiol.* 1996;22(5):388–93.
29. Hilton DA. Pathogenesis and prevalence of variant Creutzfeldt-Jakob disease. *J Pathol.* 2006;208(2):134–41.
30. Diack AB, Head MW, McCutcheon S, Boyle A, Knight R, Ironside JW, et al. Variant CJD. 18 years of research and surveillance. *Prion.* 2014;8(4):286–95.
31. Richmond JY, Hill RH, Weyant RS, Nesby-O'Dell SL, Vinson PE. What's hot in animal biosafety?. *ILAR J.* 2003;44(1):20–7.

32. Brown SA, Merritt K. Use of containment pans and lids for autoclaving caustic solutions. *Am J Infect Control*. 2003;31(4):257–60.
33. Hadar J, Tirosh T, Grafstein O, Korabelnikov E. Autoclave emissions—hazardous or not. *J Am Biol Safety Assoc*. 1997;2(3):44–51.

Appendix A—Primary Containment for Biohazards: Selection, Installation, and Use of Biological Safety Cabinets

Part 1—Introduction

This document presents information on the design, selection, function, and use of Biological Safety Cabinets (BSCs), also referred to as biosafety cabinets, which are the primary means of containment for working safely with infectious microorganisms and prions. Brief descriptions of the facility and engineering concepts for the conduct of microbiological research are also provided. BSCs are only one part of an overall biosafety program, which requires consistent use of good microbiological practices, use of primary containment equipment, and proper containment facility design. Detailed descriptions of acceptable work practices, procedures, and facilities, known as Biosafety Levels (BSL) 1 to 4, are presented in [Section IV](#) of BMBL.

BSCs are designed to provide personnel and environmental protection when appropriate practices and procedures are followed. Three kinds of BSCs, designated as Class I, II and III, have been developed to meet varying research and clinical needs. Class II and Class III cabinets provide operator, product, and environmental protection. Most BSCs use High-Efficiency Particulate Air (HEPA) filters in the exhaust and supply systems. Ultra-Low Particulate Air (ULPA) filters are used for some special applications. The exception is a Class I BSC, which has HEPA-filtered exhaust air only.

This appendix is divided into seven Parts. HEPA and ULPA filters and their use in BSCs are briefly described in Part 2. Part 3 presents a general description of the special features of BSCs that provide varying degrees of personnel, environmental, and product protection. Laboratory hazards and risk assessment are discussed in Part 4. Part 5 presents work practices, procedures, and practical tips to maximize the protection afforded by the most commonly used BSCs. Facility and engineering requirements needed for the operation of each type of BSC are presented in Part 6. Part 7 reviews requirements for routine certification intervals to ensure proper operation and integrity of a Class II BSC.

These Parts are not meant to be definitive or all-encompassing. Rather, an overview is provided to clarify the expectations, functions, and performance of these critical primary barriers. This document has been written for the biosafety professionals, laboratorians, engineers, and managers who desire a better understanding of each type of cabinet; the factors considered for the selection of a BSC to meet specific operational needs; and the services required to maintain the operational integrity of the cabinet.

Proper maintenance of BSCs used for work at all Biosafety Levels cannot be overemphasized. Biosafety professionals and laboratorians need to understand that an active BSC is a primary containment device. A BSC must be routinely inspected and tested by trained personnel, following strict protocols, to verify that it is working properly. This process, referred to as certification of the BSC, should be performed at least annually, or as specified in Part 7 of this section.

Part 2—High-Efficiency Particulate Air (HEPA) Filters and the Development of Biological Containment Devices

Since the earliest Laboratory-associated infections (LAIs) with *S. Typhi* to the contemporary hazards posed by bioterrorism, antibiotic-resistant bacteria, and rapidly mutating viruses, threats to worker safety have stimulated the development and refinement of workstations where infectious microorganisms could be safely handled. These workstations have helped maintain sterility of cell lines, minimize cross-contamination, and maintain product integrity. The use of proper procedures and equipment, as described in [Section IV](#) of BMBL, cannot be overemphasized in providing primary personnel and environmental protection. For example, high-speed blenders designed to reduce aerosol generation, needle-locking syringes, micro burners, and safety centrifuge cups or sealed rotors are among the engineered devices that protect laboratory workers from biological hazards. An important piece of safety equipment is the BSC, in which manipulations of infectious microorganisms are performed.

Background

Early prototype clean air cubicles were designed to protect the materials being manipulated from environmental or worker-generated contamination rather than to protect the worker from the risks associated with the manipulation of potentially hazardous materials. Filtered air was blown across the work surface directly at the worker. Therefore, these cubicles could not be used for handling infectious agents because the worker was in a contaminated air stream.

To protect the worker during manipulations of infectious agents, a small workstation was needed that could be installed in existing laboratories with minimum modification to the room. The earliest designs for primary containment devices were essentially non-ventilated boxes built of wood, and later of stainless steel, in which simple operations such as weighing materials could be accomplished.¹

Early versions of ventilated cabinets did not have adequate or controlled directional air movement. They were characterized by mass airflow into the cabinets with widely varying air volumes across openings. Mass airflow into a cabinet drew contaminated air away from the laboratory worker. This was the forerunner of the Class I BSC. However, since the inflow air was unfiltered, the cabinet

was contaminated with environmental microorganisms and other undesirable particulate matter.

Control of airborne particulate materials became possible with the development of filters that efficiently removed microscopic contaminants from the air. The HEPA filter was developed to create dust-free work environments (e.g., cleanrooms and clean benches) in the 1940s.¹

HEPA and ULPA Filters HEPA filters used in most BSCs remove the Most Penetrating Particle Size (MPPS) of approximately 0.3 µm with a minimum efficiency of 99.99%, while ULPA filters remove particles of average size 0.1–0.2 µm or 0.2–0.3 µm with minimum efficiency of 99.999%.² Particles both larger and smaller than the MPPS (including bacterial spores and viruses) are removed with greater efficiency. HEPA and ULPA filter efficiency and the mechanics of particle collection by these filters are well-studied and well- documented; therefore, only a brief description is included here.^{3,4}

The typical HEPA filter medium is a single sheet of borosilicate fibers treated with a wet-strength, water-repellant binder. Advances in filtration science have also seen the introduction of HEPA and ULPA filters with different media types such as polytetrafluoroethylene (PTFE [i.e., Teflon]) for use in BSCs and similar devices. The filter medium is pleated to increase the overall surface area inside the filter frames and the pleats are often divided by corrugated aluminum separators (Figure 1). The separators prevent the pleats from collapsing in the air stream and provide a path for airflow. Alternate designs providing substitutions for the aluminum separators may also be used and are known as separatorless filters. The filter is glued into a wood, metal, or plastic frame. Careless handling of the filter (e.g., improper storage or dropping) can damage the medium at the glue joint and cause tears or shifting of the filter resulting in leaks in the medium. This is the primary reason why filter integrity must be tested when a BSC is installed initially and each time it is moved or relocated (Part 7).

Various types of containment and similar devices incorporate the use of HEPA and ULPA filters in the exhaust and/or supply air system to remove airborne particulate material. It should be noted that, although ULPA filters can be used in BSCs, there is not at this time a specific situation that requires them. ULPA filters are more expensive to purchase and can raise energy costs and be detrimental to the lifespan of the device motors due to the increased resistance through the filter. Depending on the configuration of these filters and the direction of the airflow, varying degrees of personnel, environmental, and product protection can be achieved.⁵ Part 5 describes the proper practices and procedures necessary to maximize the protection afforded by the various devices.

Part 3—Biological Safety Cabinets

The similarities and differences in protection offered by the various classes of BSCs are reflected in Table 1. Please also refer to Table 2 and Part 4 for further considerations pertinent to BSC selection and risk assessment.

The Class I BSC

The Class I BSC provides personnel and environmental protection but no product protection. It is similar in terms of air movement to a chemical fume hood but has a HEPA filter in the exhaust system to protect the environment (Figure 2). In the Class I BSC, unfiltered room air is drawn in through the work opening and across the work surface. Personnel and environmental protection is provided by a minimum inward airflow velocity of 75 linear feet per minute (lfm) through the front opening.⁶ Because product protection is provided by the Class II BSCs, general usage of the Class I BSC has declined. Class I BSCs are used where aerosols may be generated and product protection is not required, such as for cage dumping, culture aeration, or tissue homogenization, or to enclose equipment (e.g., centrifuges, harvesting equipment, or small fermenters).

The classical Class I BSC is direct-connected to the building exhaust system and the building exhaust fan provides the negative pressure necessary to draw room air into the cabinet. The airflow pattern into a Class I is similar to a chemical fume hood where unfiltered laboratory air flows inward over the product. Any aerosols and particulates are pulled into an exhaust plenum that contains a HEPA filter, which filters out the aerosols and particulates.

Some Class I BSCs are equipped with an integral exhaust fan. In this case, the cabinet air may be recirculated into the laboratory if no noxious or toxic gases or vapors are used. This Class I BSC may also be canopy connected with an exhaust alarm when hazardous gases or vapors are used.

A panel with openings to allow access for the hands and arms to the work surface can be added to the Class I cabinet. The restricted opening results in increased inward air velocity, increasing worker protection. For added safety, arm-length gloves can be attached to the panel. Makeup air is then drawn through an auxiliary air supply opening (which may contain a filter) and/or around a loose-fitting front panel.

Some Class I models used for animal cage changing are designed to allow recirculation of air into the room after HEPA filtration and may require more frequent filter replacement due to filter loading and odor from organic material captured on the filter.

All Class I BSCs should be certified annually for sufficient airflow and filter integrity.

The Class II BSC

As biomedical researchers began to use sterile animal tissue and cell culture systems, particularly for the propagation of viruses, cabinets were needed that also provided product protection. In the early 1960s, the *laminar flow* principle evolved. Unidirectional air moving at a fixed velocity along parallel lines was demonstrated to reduce turbulence resulting in predictable particle behavior. Biocontainment technology also incorporated this laminar or uniform, directional flow principle with the use of the HEPA filter to aid in the capture and removal of airborne contaminants from the air stream.⁷ This combination of technologies that exists in the Class II BSC serves to help protect the laboratory worker from potentially infectious aerosols⁴ generated within the cabinet and also provides necessary product protection. Class II BSCs are partial barrier systems that rely on the directional movement of air to provide containment. As the air curtain is disrupted (e.g., movement of materials in and out of a cabinet, rapid or sweeping movement of the arms) the potential for contaminant release into the laboratory work environment is increased, as is the risk of product contamination.

The Class II (Types A1, A2, B1, B2, and C1)⁸ BSCs provide personnel, environmental, and product protection. Airflow is drawn into the front grille of the cabinet, providing personnel protection. In addition, the downward flow of HEPA-filtered air provides product protection by minimizing the chance of cross-contamination across the work surface of the cabinet. Because cabinet exhaust air is passed through a certified HEPA filter, it is particulate-free (environmental protection), and may be recirculated to the laboratory (Type A1, A2, and C1 BSCs) or discharged from the building through a canopy (formerly thimble) connected to the building exhaust.

It is possible to exhaust the air from a Type A1, A2, or C1 cabinet outside of the building. When using volatile toxic chemicals, removal of the exhaust from the laboratory is required. However, it must be done in a manner that does not alter the balance of the cabinet exhaust system, thereby disturbing the internal cabinet airflow. The proper method of connecting a Type A1, A2, or C1 cabinet to the building exhaust system is through use of a canopy connection,^{8,9} which provides a small opening or air gap (usually one inch) around the cabinet exhaust filter housing (Figure 4). The airflow of the building exhaust must be sufficient to maintain the flow of room air into the gap between the canopy unit and the filter housing. The canopy must be removable or be designed to allow for operational testing of the cabinet and must have an alarm to indicate insufficient airflow through the canopy (Part 6). Class II, Type A1 or A2 cabinets should never be direct-connected to the building exhaust system.⁸ Fluctuations in air volume and pressure that are common to all building exhaust systems can make it difficult to match the airflow requirements of the cabinet.

Type B cabinets must be direct-connected, preferably to a dedicated, independent exhaust system. Fans for laboratory exhaust systems should be located at the terminal end of the ductwork to avoid pressurizing the exhaust ducts. A failure in the building exhaust system may not be apparent to the user, as the supply blowers in the cabinet will continue to operate. A pressure-independent monitor and alarm must be installed to provide a warning and shut off the BSC supply fan, should a failure in exhaust airflow occur. Since this feature is not supplied by all cabinet manufacturers, it is prudent to install a sensor such as a flow monitor and alarm in the exhaust system as necessary. To maintain critical operations, laboratories using Type B BSCs should connect the exhaust blower to the emergency power supply.

HEPA filters are effective at trapping particulates, and thus infectious agents, but do not capture volatile chemicals or gases. Only canopy-connected Type A1, A2, and C1 or Types B1 and B2 BSCs should be used when working with volatile, toxic chemicals, but amounts must be limited (Table 2).

The mechanical design and air balance testing of the laboratory exhaust system for Class IIB BSCs must use Concurrent Balance Values (CBV) as published in the NSF/ANSI 49 Standard—a standard that describes the requirements for the construction and function of a Class II BSC.⁸ When a BSC is certified to NSF/ANSI 49-2018, the standard method is to set the inflow velocities using a direct inflow measurement (DIM) hood. When the HVAC system air balance is set, it is typically done based on duct traverse air measurements taken at some point in the ductwork. The two groups are attempting to measure and set the BSC inflows, but each is using a different type of instrument and taking airflow measurements at different locations. There can be a difference in air volume measurements between the two. The CBV provides each discipline the information they require to properly test or certify the BSC.

All Class II cabinets are designed for work involving microorganisms assigned to Risk Groups (RG) 1–4. Class II BSCs provide the microbe-free work environment necessary for cell culture propagation and also may be used for the formulation of nonvolatile antineoplastic or chemotherapeutic drugs.^{10,11} Class II BSCs may be used with organisms requiring BSL-4 containment in a BSL-4 suit laboratory by a worker wearing a positive-pressure protective suit. Maximum containment potential is achieved only through strict adherence to proper practices and procedures.

Class II, Type A1 BSC An internal fan (Figure 3) draws sufficient room air through the front grille to maintain a minimum calculated or measured average inflow velocity of at least 75 lfm at the face opening of the cabinet. The supply air flows through a HEPA filter and provides particulate-free air to the work surface. Airflow provided in this manner reduces turbulence in the work zone and minimizes the potential for cross-contamination.

The downward moving air splits as it approaches the work surface; the fan draws part of the air to the front grille and the remainder to the rear grille. Although there are variations among different cabinets, this split generally occurs about halfway between the front and rear grilles and two to six inches above the work surface.

The air is drawn through the front and rear grilles by the internal fan and pushed into the space between the supply and exhaust filters. Due to the relative size of these two filters, approximately 30% of the air passes through the exhaust HEPA filter and 70% recirculates through the supply HEPA filter back into the work zone of the cabinet. Most Class II, Type A1, and A2 cabinets have dampers to modulate this division of airflow.

Since 2010, a Class II A1 cabinet may not have a potentially contaminated positively pressurized plenum that is not surrounded by a negatively pressurized plenum. This change has minimized the difference between an A1 and A2 cabinet to the inflow velocity.

Class II, Type A2 BSC (Formerly called A/B3) Only when this BSC (Figure 3) is ducted to the outdoors does it meet the requirements of the former Class II, Type B3.⁸ The designation Class II B3 is no longer used. The Type A2 cabinet has a minimum calculated or measured inflow velocity of 100 lfm. All positive-pressure contaminated plenums within the cabinet are surrounded by a negative air pressure plenum thus ensuring that any leakage from a contaminated plenum will be drawn into the cabinet and not released to the environment. Small quantities of volatile toxic chemicals or radionuclides can be used in a Type A2 cabinet only if it exhausts to the outside via a properly functioning canopy with exhaust alarm.⁸

Class II, Type B1 BSC Some biomedical research requires the use of small quantities of toxic volatile chemicals, such as organic solvents or carcinogens. Carcinogens used in cell culture or microbial systems require both biological and chemical containment.⁹

The Class II, Type B cabinet originated with the National Cancer Institute (NCI)-designed Type 212 (later called Type B) BSC (Figure 5a) and was designed for manipulations of small quantities of toxic volatile chemicals with *in vitro* biological systems. The NSF/ANSI 49-2018 definition of Type B1 cabinets⁸ includes this classic NCI design Type B; cabinets without a supply HEPA filter located immediately below the work surface (Figure 5b); and those with exhaust/recirculation downflow ratios other than 70/30%.

The cabinet supply blower draws room air (plus a portion of the cabinet's recirculated air) through the front grille and through the supply HEPA filter located immediately below the work surface. This particulate-free air flows upward through a plenum at each side of the cabinet and then downward to the work area through

a backpressure plate. In some cabinets, there is an additional supply HEPA filter to remove particulates that may be generated by the blower-motor system.

Room air is drawn through the face opening of the cabinet at a minimum measured inflow velocity of 100 lfm. As with the Type A1 and A2 cabinets, there is a split in the down-flowing air stream just above the work surface. In the Type B1 cabinet, approximately 70% of the downflow air exits through the rear grille, passes through the exhaust HEPA filter, and is discharged from the building. The remaining 30% of the downflow air is drawn through the front grille. Since the air that flows to the rear grille is discharged into the exhaust system, activities that may generate toxic volatile chemical vapors or gases should be conducted toward the rear of the cabinet work area.¹²

Class II, Type B2 BSC This BSC is a total-exhaust cabinet; no air is recirculated within it (Figure 6). This cabinet provides simultaneous primary biological and chemical (small quantity) containment. Consideration must be given to the chemicals used in BSCs as some chemicals can destroy the filter medium, housings, and/or gaskets causing loss of containment. The supply blower draws either room or outside air in at the top of the cabinet, passes it through a HEPA filter and down into the work area of the cabinet. The building exhaust system draws air through both the rear and front grilles, capturing the supply air plus the additional amount of room air needed to produce a minimum calculated or measured inflow face velocity of 100 lfm. All air entering this cabinet is exhausted and passes through a HEPA filter (and perhaps some other air-cleaning device, such as a carbon filter, if required, for the work being performed prior to discharge to the outside). This cabinet exhausts as much as 1,200 cubic feet per minute of conditioned room air making this cabinet expensive to operate. The higher static air pressure required to operate this cabinet also results in additional costs associated with heavier gauge ductwork and higher capacity exhaust fan. Therefore, the need for a Class II, Type B2 should be justified by the risk assessment of the research to be conducted.

Should the building exhaust system fail, the cabinet will be pressurized, resulting in a flow of air from the work area back into the laboratory.

Cabinets built since the early 1980s have an interlock system, installed by the manufacturer, to prevent the supply blower from operating whenever the exhaust flow is insufficient; systems can be retrofitted. Exhaust air movement should be monitored by a pressure-independent device, such as a flow monitor.

Class II, Type C1 BSC This BSC is similar to a Type B1 BSC in that it has a special region of the work area intended for work with toxic volatile chemicals that are exhausted from the building (Figure 7a). However, it also has an internal exhaust blower that allows the BSC to be either room recirculated if no volatile toxic chemicals or vapors are present or canopy-connected with an exhaust alarm

if volatile toxic chemicals are used. Room air is drawn through the face opening of the cabinet at a minimum measured inflow velocity of 100 fpm. The down-flowing air stream just above the work surface is split by a specific grille pattern with a portion of 70% to be exhausted and the remaining 30% recirculated. If the air that flows over the specific region is discharged into the exhaust system, activities that may generate toxic, volatile chemicals or gases must only be conducted in that area of the cabinet work zone if connected to a properly functioning canopy with alarm (Figure 7b). If canopy connected during a building system failure, the BSC must be either interlocked with the cabinet blower(s) alarm to shut off the cabinet or, if using a sealed and tested duct system and if permitted by a chemical risk assessment, may continue to operate for up to five minutes pressurizing the duct and indicating the time remaining before the BSC is shut off.

Special Applications Class II BSCs can be modified to accommodate special tasks. For example, the front sash can be modified by the manufacturer to accommodate the eyepieces of a microscope. The work surface can be designed to accept a carboy, a centrifuge, or other equipment that may require containment. A rigid plate with openings for the arms can be added if needed. Good cabinet design, microbiological aerosol tracer testing of the modification, and appropriate certification (Part 7) are required to ensure that the basic systems operate properly after modification (Part 5).

The Class III BSC

The Class III BSC (Figure 8) was designed for work with highly infectious microbiological agents and the conduct of hazardous operations and provides maximum protection for the environment and the worker. It is a gas-tight (no leak greater than 1×10^{-7} cc/sec with 1% test gas at three inches pressure water gauge¹³) enclosure with a non-opening view window. Access for passage of materials into the cabinet is through a dunk tank that is accessible through the cabinet floor or a double-door pass-through box (e.g., antechamber, autoclave) that can be decontaminated between uses. Reversing that process allows materials to be removed from the Class III BSC safely. Both supply and exhaust air are HEPA-filtered on a Class III cabinet. Exhaust air must pass through two HEPA filters, or a HEPA filter and an air incinerator, before discharge directly to the outdoors. Class III cabinets are not exhausted through the general laboratory exhaust system. Using a dedicated exhaust system reduces the risk of outside ventilation influences on Class III containment performance. Airflow is maintained by an exhaust system exterior to the cabinet, which keeps the cabinet under negative pressure (minimum of 0.5 in water gauge). This level of negative pressure is required to minimize risk and maintain containment if a breach occurs such as holes or tears in the glove system.

Long, heavy-duty rubber gloves are attached in a gas-tight manner to ports in the cabinet to allow direct manipulation of the materials isolated inside. Although

these gloves restrict movement, they prevent the user's direct contact with the hazardous materials. The trade-off is clearly on the side of maximizing personal safety. Depending on the design of the cabinet, the supply HEPA filter provides particulate-free, albeit somewhat turbulent, airflow within the work environment. Laminar or uniform airflow is optional but not a typical characteristic of a Class III cabinet.

Several Class III BSCs can be joined together in series to provide a larger work area. Such cabinet lines are custom-built; the equipment installed in the cabinet series (e.g., refrigerators, small elevators, shelves to hold small animal cage racks, microscopes, centrifuges, incubators) is generally custom-built as well.

Horizontal Laminar Flow Clean Bench Horizontal laminar flow clean benches (also referred to as clean air devices [CADs]) are not BSCs (Figure 9a). These pieces of equipment discharge HEPA-filtered air from the back of the cabinet across the work surface and toward the user. These devices only provide product protection. They can be used for certain clean activities, such as the dust-free assembly of sterile equipment or electronic devices. Clean benches should never be used when handling cell culture materials, drug formulations, potentially infectious materials, or any other potentially hazardous materials. The worker will be exposed to the materials being manipulated on the clean bench potentially resulting in hypersensitivity, toxicity, or infection depending on the materials being handled. Horizontal airflow clean benches must never be used as a substitute for a biological safety cabinet. Users must be aware of the differences between these two devices.

Vertical Flow Clean Bench Vertical flow clean benches or CADs (Figure 9b) also are not BSCs. They may be useful, for example, in hospital pharmacies when a clean area is needed for preparation of intravenous solutions or for the preparation of nucleic acids for PCR. While these units generally have a sash, the air is usually discharged into the room under the sash, resulting in the same potential worker exposure issues presented by the horizontal laminar flow clean benches. These benches should never be used when handling cell culture materials, drug formulations, potentially infectious materials, or any other potentially hazardous materials.

Part 4—Other Laboratory Hazards and Risk Assessment

Primary containment is an important strategy in minimizing exposure to the many chemical, radiological and biological hazards encountered in the laboratory. In Table 2, an overview is provided of the various classes of BSCs, the level of containment afforded by each, and the appropriate risk assessment considerations. Microbiological risk assessment is addressed in depth in [Section II](#) of BMBL.

Working with Chemicals in BSCs

Work with infectious microorganisms often requires the use of various chemical agents, and many commonly used chemicals vaporize easily. Therefore, evaluation of the inherent hazards of the chemicals must be part of the risk assessment when selecting a BSC. Flammable chemicals should not be used in Class II, Type A1, A2, and non-ducted Type C1 cabinets since vapor buildup inside the cabinet presents a fire hazard. In order to determine the greatest chemical concentration that might be entrained in the air stream following an accident or spill, it is necessary to evaluate the quantities to be used. Mathematical models are available to assist in these determinations.¹² For more information regarding the risks associated with exposure to chemicals, the reader should consult the Permissible Exposure Levels determined under OSHA regulations available at <https://www.osha.gov/dsg/annotated-pels/tablez-1.html> and Threshold Limit Values (TLVs) for various chemical substances established by the American Conference of Governmental Industrial Hygienists.¹⁴

The electrical systems of Class II BSCs are not spark-proof. Therefore, a chemical concentration approaching the lower explosive limits of the compound must be prohibited. Furthermore, since non-exhausted Class II, Type A1, A2, and C1 cabinets return chemical vapors to the cabinet workspace and the room, they may expose the operator and other room occupants to toxic chemical vapors.

A chemical fume hood should be used for procedures using volatile chemicals instead of a BSC when biological containment is not needed. Chemical fume hoods are connected to an independent exhaust system and operate with single-pass air discharged, directly or through a manifold, outside the building. They may also be used when manipulating chemical carcinogens.⁹ When manipulating small quantities of volatile, toxic chemicals, required for use in microbiological studies, Class I and Class II (Type B1 and B2) BSCs, exhausted to the outdoors, can be used. The Class II, Type A1, A2, and C1 canopy-exhausted cabinets may be used with small quantities of volatile, toxic chemicals.⁸

Many liquid chemicals, including nonvolatile antineoplastic agents, chemotherapeutic drugs and low-level radionuclides, can be safely handled inside properly canopy connected Class II, Type A, and C1 cabinets.^{10,11} Class II BSCs should not be used for labeling of biohazardous materials with radioactive iodine or other volatile radionuclides. Hard-ducted, ventilated containment devices incorporating both HEPA and charcoal filters in the exhaust systems are necessary for the conduct of this type of work.

Many virology and cell culture laboratories use diluted preparations of chemical carcinogens^{15,16} and other toxic substances. Prior to maintenance, a careful evaluation must be made of potential problems associated with decontaminating the cabinet and the exhaust system. Air treatment systems, such as a charcoal filter¹⁶

may be required so that discharged air meets applicable emission regulations. A bag-in/bag-out housing may be needed to reduce the exposure risk to workers replacing chemically contaminated filters.

Radiological Hazards in the BSC

As indicated above, volatile radionuclides such as I^{125} should not be used within Class II BSCs. When using nonvolatile radionuclides inside a BSC, the same hazards exist as if working with radioactive materials on the benchtop. Work with nonvolatile radionuclides that has the potential for splatter or creation of aerosols can be done within the BSC.

Radiologic monitoring must be performed. A straight, vertical (i.e., not sloping) beta shield may be used inside the BSC to provide worker protection. A sloping shield can disrupt the air curtain and increase the possibility of contaminated air being released from the cabinet. A radiation safety professional should be contacted for specific guidance.

Risk Assessment

The potential for adverse events must be evaluated to eliminate, or reduce to the greatest extent possible, worker exposure to infectious organisms and to prevent release to the environment. Agent summary statements, detailed in [Section VIII](#) of BMBL or from other reputable sources, such as the Public Health Agency of Canada, provide data for microorganisms known to have caused Laboratory-associated infections that may be used in protocol-driven risk assessments. Through the process of risk assessment, the laboratory environment and the work to be conducted are evaluated to identify hazards and develop interventions to reduce risks to an acceptable level.

A properly certified and operational BSC is an effective engineering control (Part 6) that must be used in concert with the appropriate practices, procedures, and other administrative controls to further reduce the risk of exposure to potentially infectious microorganisms. Suggested work practices and procedures for minimizing risks when working in a BSC are detailed in Part 5.

Part 5—BSC Use by the Investigator: Work Practices and Procedures

Preparing for Work within a Class II BSC

Preparing a written checklist of materials necessary for a particular activity and placing necessary materials in the BSC before beginning work serves to minimize the number and extent of air curtain disruptions compromising the fragile air barrier of the cabinet. The rapid movement of a worker's arms in a sweeping motion into and out of the cabinet will disrupt the air curtain and compromise the partial containment barrier provided by the BSC. Moving arms in and out slowly, perpendicular to the face opening of the cabinet will reduce

this risk. Other personnel activities in the room (e.g., rapid movements near the face of the cabinet, walking traffic, room fans, open/closing room doors) may also disrupt the cabinet air barrier.⁶

Laboratory coats, preferably with knit or elastic cuffs, should be worn buttoned over street clothing; latex, vinyl, nitrile, or other suitable gloves are worn to provide hand protection. Increasing levels of PPE may be warranted as determined by an individual risk assessment. For example, a solid-front, back-closing laboratory gown provides better protection of personal clothing than a traditional laboratory coat and is a recommended practice at BSL-3.

Before beginning work, the investigator should adjust the stool height in an ergonomic position with proper back and feet support so that his/her face is above the front opening. Manipulation of materials should be delayed for approximately one minute after placing the hands/arms inside the cabinet. This allows the cabinet to stabilize, to *air sweep* the hands and arms, and to allow time for turbulence reduction. When the user's arms rest flatly across the front grille, occluding the grille opening, room air laden with particles may flow directly into the work area, rather than being drawn down through the front grille. Raising the arms slightly will alleviate this problem. Ergonomic elbow rests can also be used that elevate the elbows above the front grille so as to not disrupt the airflow and keep the user's arms and shoulders in a comfortable position. The front grille must not be blocked with such things as toweling, research notes, discarded plastic wrappers, and/or pipetting devices. All operations should be performed on the work surface at least four inches in from the front grille. If there is a drain valve under the work surface, it should be closed prior to beginning work in the BSC.

Materials or equipment placed inside the cabinet may cause disruption of the airflow, resulting in turbulence, possible cross-contamination, and/or breach of containment. Extra supplies (e.g., additional gloves, culture plates or flasks, culture media) should be stored outside the cabinet. Only the materials and equipment required for the immediate work should be placed in the BSC.

For some laboratory applications, specially designed BSCs containing large pieces of specialized equipment such as cell analyzers, flow cytometers, incubators, and centrifuges may be installed by the manufacturer and will require field certification. In those instances, the manufacturer should supply to the user the certification testing methodology information that assures the BSC will pass containment to NSF/ANSI 49-2018. In situations where a user places a new or different piece of equipment in the BSC, whether it is a special BSC or standard model, smoke visualization with equipment operational is required to field verify containment performance. The certifier should consult with the manufacturer during smoke visualization testing to provide guidance for the certification evaluation.

BSCs are performance verified by the manufacturer for use by a single individual at any given time. If it is deemed necessary by a facility for more than one person to be working in a BSC at the same time it should only be done after performing a comprehensive risk assessment for both product and personnel that encompasses hazard identification, exposure assessment, dose-response assessment, risk characterization, and a risk mitigation strategy.

BSCs are designed for 24-hour per day operation and some investigators believe that continuous operation of non-canopied Class IIA BSCs helps control the laboratory's level of dust and other airborne particulates. Although energy conservation may suggest BSC operation only when needed, especially if the cabinet is not used routinely, room air balance is an overriding consideration. Air discharged through ducted BSCs must be considered in the overall air balance of the laboratory. If night setback modes are used for BSC's, they must be interlocked to the laboratory supply and exhaust system to maintain negative laboratory air balance.

If the cabinet has been shut down, the blowers should be operated at least five minutes before beginning work to allow the cabinet to purge. This purge will remove any suspended particulates in the cabinet. The work surface, the interior walls (except the supply filter diffuser), and the interior surface of the window should be wiped with 70% ethanol (EtOH), a 1:100 dilution of household bleach (i.e., 0.05% sodium hypochlorite), or other disinfectant as determined by the investigator to meet the requirements of the particular activity. When bleach is used, a second wiping with sterile water is needed to remove the residual chlorine, which may eventually corrode stainless steel surfaces. Wiping with non-sterile water may recontaminate cabinet surfaces, which is a critical issue when sterility is essential (e.g., maintenance of cell cultures).

Similarly, the surfaces of all materials and containers placed into the cabinet should be wiped with 70% EtOH or other disinfectant determined to meet the laboratory's need to reduce the introduction of contaminants to the cabinet environment. This simple step will reduce introduction of mold spores and thereby minimize contamination of cultures. Further reduction of microbial load on materials to be placed or used in BSCs may be achieved by periodic decontamination of incubators and refrigerators.

Material Placement inside the BSC

Plastic-backed, absorbent toweling can be placed on the work surface but not on the front or rear grille openings. The use of toweling facilitates routine cleanup and reduces splatter and aerosol generation¹⁷ during an overt spill. It can be folded and placed in a biohazard bag or other appropriate waste receptacle when work is completed.

All materials should be placed as far back in the cabinet as practical, toward the rear edge of the work surface and away from the front and back grille of the cabinet. Similarly, aerosol-generating equipment (e.g., vortex mixers, tabletop centrifuges) should be placed toward the rear of the cabinet to take advantage of the air split described in Part 3. Bulky items such as biohazard bags, discard pipette trays, and vacuum collection flasks should be placed to one side of the interior of the cabinet. If placing those items in the cabinet requires opening the sash, make sure that the sash is returned to its original position before work is initiated. The correct sash position should be indicated on the front of the cabinet. An audible alarm will sound if the sash is in the wrong position while the fan is operating. Biological material or other hazardous agents should be placed in the BSC last.

Certain common practices interfere with the operation of the BSC. The biohazard collection bag should not be taped to the outside of the cabinet. This practice encourages the BSC user to frequently move in and out of the BSC to move discarded materials into the outside bag. Movement in and out of the BSC should be minimized to reduce the risk of biohazardous materials being brought out of the BSC or room contamination being brought into the BSC. Upright pipette collection containers should neither be used in BSCs nor placed on the floor outside the cabinet. The frequent inward/outward movement needed to place objects in these containers is disruptive to the integrity of the cabinet air barrier and can compromise both personnel and product protection. Horizontal pipette discard trays, which may contain an appropriate chemical disinfectant, should be used within the cabinet. Large sharps containers will interfere with the downward airflow and should not be used. Furthermore, potentially contaminated materials should not be brought out of the cabinet until they have been surface decontaminated or placed into a closable waste container for transfer to an incubator, autoclave, or another part of the laboratory. The closable waste container should also be surface decontaminated prior to removal.

Operations within a Class II BSC

Laboratory Hazards Many procedures conducted in BSCs may create splatter or aerosols. Good microbiological techniques should always be used when working in a BSC. For example, techniques used to reduce splatter and aerosol generation will also minimize the potential for personnel exposure to infectious materials manipulated within the cabinet. Class II cabinets are designed so that horizontally nebulized spores introduced into the cabinet will be captured by the downward flowing cabinet air within 14 in⁸ of travel. Therefore, keeping clean materials at least one foot away from aerosol-generating activities will minimize the potential for cross-contamination.

The workflow should be from clean to dirty (Figure 10). Materials and supplies should be placed in the cabinet in such a way as to limit the movement of dirty items over clean ones.

Several measures can be taken to reduce the chance for cross-contamination of materials when working in a BSC. Opened tubes or bottles should not be held in a vertical position. Investigators working with Petri dishes and tissue culture plates should hold the lid above the open sterile surface to minimize direct impaction of downward air. Bottle or tube caps should not be placed on the towel if used. Items should be recapped or covered as soon as possible.

Open flames are neither required nor recommended in the near microbe-free environment of a biological safety cabinet. On an open bench, flaming the neck of a culture vessel will create an upward air current that prevents microorganisms from falling into the tube or flask. An open flame in a BSC, however, creates turbulence that disrupts the pattern of HEPA-filtered air being supplied to the work surface. When deemed absolutely necessary and approved by the appropriate facility authorities after a thorough risk assessment, touch-plate micro burners equipped with a pilot light to provide a flame on demand may be used. Internal cabinet air disturbance and heat buildup will be minimized. The burner must be turned off when work is completed. Small electric furnaces are available for decontaminating bacteriological loops and needles and are preferable to an open flame inside the BSC. Disposable loops should be used whenever possible.

Aspirator bottles or suction flasks should be connected to an overflow collection flask containing appropriate disinfectant and to an in-line HEPA or equivalent filter (Figure 11). Commercial equivalents are acceptable once validated for specific laboratory use. This combination will provide protection to the central building vacuum system or vacuum pump, as well as to the personnel who service this equipment. Inactivation of aspirated materials can be accomplished by placing a volume of a chemical decontamination solution having a concentration of chemical sufficient to decontaminate microorganisms when the flask is filled to its maximum capacity into the flask to inactivate the microorganisms as they are collected. Once inactivation occurs, liquid materials can be disposed of as noninfectious waste. The flask material should be resistant to the decontamination solution used.

Investigators must determine the appropriate method of decontaminating wastes that will be removed from the BSC at the conclusion of the work. When chemical means alone are appropriate, a suitable liquid disinfectant should be placed into a discard pan before work begins. Items should be introduced into the pan with minimum splatter, covered completely, and allowed appropriate contact time as per manufacturer's instructions. Alternatively, liquids can be autoclaved prior to disposal. The liquid container should be placed in a suitable, secondary container,

and the outside of these containers wiped with a suitable liquid disinfectant, prior to removal from the BSC.

When a steam autoclave is used for solid wastes, contaminated materials should be placed into a biohazard bag or discard pan. Adding water to ensure steam generation during the autoclave cycle needs to be determined experimentally. The bag should be loosely closed (to allow steam to enter the bag) or the discard pan should be covered in the BSC prior to transfer to the autoclave. The bag should be transported and autoclaved in a leak-proof tray or pan. It is a prudent practice to decontaminate the exterior surface of bags and pans just prior to removal from the cabinet.

Decontamination

Cabinet Surface Decontamination With the cabinet blower running, all containers and equipment should be surface decontaminated and removed from the cabinet when work is completed. All biological materials and hazardous agents should be removed first. At the end of the workday, the final surface decontamination of the cabinet should include a wipe-down of the work surface, the cabinet's sides and back, and the interior of the glass. If necessary, the cabinet should also be monitored for radioactivity and decontaminated when necessary. Investigators should remove their gloves and gowns in a manner to prevent contamination of unprotected skin and aerosol generation and wash their hands as the final step in safe microbiological practices. The cabinet blower may be left on or turned off after these operations are completed.

Small spills within the operating BSC can be handled immediately by removing the contaminated absorbent paper toweling and placing it into the biohazard bag or receptacle. Small spills inside the BSC can be covered with paper towels, and starting from the outside of the spill, covered in an appropriate disinfectant. Once appropriate contact time is reached, usually 20 to 30 minutes, towels should be pushed from the edge of the spill to the center and disposed of into a biohazard bag or receptacle. Cabinet interior and items inside the BSC should be wiped down with a towel dampened with disinfectant. Gloves should be changed after the work surface is decontaminated and before placing clean absorbent toweling, if used in the cabinet.

Spills large enough to result in liquids flowing through the front or rear grilles require decontamination that is more extensive. All items within the cabinet should be surface decontaminated and removed. After ensuring that the drain valve is closed, decontaminating solution can be poured onto the work surface and through the grille(s) into the drain pan. The drain pan should be emptied into a collection vessel containing disinfectant. A hose barb and flexible tube should be attached to the drain valve and be of sufficient length to allow the open end to be submerged in the disinfectant within the collection vessel. This procedure

serves to minimize aerosol generation. The drain pan should be flushed with water, the drain tube removed, and the drain valve closed.

Should the spilled liquid contain a hazardous chemical or radioactive material, a similar procedure can be followed. The appropriate safety personnel should be contacted for specific instructions.

Periodic removal of the cabinet work surface and/or grilles after the completion of drain pan decontamination is recommended because of dirty drain pan surfaces and grilles, which ultimately could occlude the drain valve or block airflow. However, extreme caution should be observed while wiping these surfaces to avoid injury from sharp metal edges and other items (e.g., broken glass, pipette tips) that may be present. Always use disposable paper toweling and avoid applying harsh force. Wipe dirty surfaces gently. Never leave toweling on the drain pan because the paper could block the drain valve or the air passages in the cabinet.

Gas Decontamination BSCs that have been used for work involving infectious materials must be decontaminated before HEPA filters are changed or internal repair work is done.^{8,18–20} Before a BSC is relocated, a risk assessment considering the agents manipulated within the BSC must be performed to determine the need and method for decontamination. The most common decontamination methods use formaldehyde gas, hydrogen peroxide vapor,⁸ or chlorine dioxide gas.

Part 6—Facility and Engineering Requirements

Secondary Barriers

BSCs are considered the primary containment barrier for manipulation of infectious materials, and the laboratory room itself is considered the secondary containment barrier.²¹ Inward directional airflow is established by²² exhausting a greater volume of air than is supplied to a given laboratory and by drawing makeup air from the adjacent space. This is optional at BSL-2 but must be maintained at BSL-3 and BSL-4.²³ The air balance for the entire facility should be established and maintained to ensure that airflow is from areas of least to greater potential contamination.

Building Exhaust BSL-4 laboratory air must be directly exhausted to the outside since it is considered potentially contaminated. This concept is referred to as a dedicated, single-pass exhaust system. The exhausted room air can be HEPA-filtered when a high level of aerosol containment is needed, which is always true at BSL-4, but is an enhancement at BSL-3 and recommended for work with some organisms.³ When the building exhaust system is used to vent a Class IIB BSC, the exhaust system must be designed using the CBV and have sufficient capacity to maintain the exhaust flow if changes in the static pressure within the system should occur.⁸ The connection to a BSC must be constant air volume (CAV).

The HVAC exhaust system must be sized to handle both the room exhaust and the exhaust requirements of all containment devices that may be present. Adequate supply air must be provided to ensure appropriate function of the exhaust system. Right-angle bends, changing duct diameters, and transitional connections within the systems will add to the demand on the exhaust fan. The building exhaust air should be discharged away from supply air intakes, to prevent re-entrainment of laboratory exhaust air into the building air supply system. Refer to recognized design guides for locating the exhaust terminus relative to nearby air intakes.²⁴

Utility Services Utility services needed within a BSC must be planned carefully. Protection of vacuum systems must be addressed (Figure 11). Electrical outlets inside the cabinet must be protected by ground fault circuit interrupters and should be supplied by an independent circuit. The use of open flames in the BSC is not recommended.⁸ In very rare instances, when propane or natural gas needs to be provided, a clearly marked emergency gas shut-off valve outside the cabinet must be installed for fire safety. All non-electrical utility services should have exposed, accessible shut-off valves. The use of compressed air within a BSC must be carefully considered and controlled to prevent aerosol production and reduce the potential for vessel pressurization.

Ultraviolet Lamps Ultraviolet (UV) lamps should not be used as the sole disinfection method in a BSC. If installed, UV lamps should be cleaned regularly to remove any film that may block the output of the lamp. The lamps should be evaluated regularly and checked with a UV meter to ensure that the appropriate intensity of UV light is being emitted. Replace the bulb when the fluence rate is below 40 $\mu\text{W}/\text{cm}^2$. Unshielded UV lamps must be turned off when the room is occupied to protect eyes and skin from UV exposure. If the cabinet has a sliding sash, close the sash when operating the UV lamp. Most new BSCs use sliding sashes that are interlocked when operating the UV lamp to prevent exposure.

BSC Placement BSCs were developed as workstations to provide personnel, environmental, and product protection during the manipulation of infectious microorganisms. Certain considerations must be met to ensure maximum effectiveness of these primary barriers. Whenever possible, adequate clearance should be provided behind and on each side of the cabinet to allow easy access for maintenance and to ensure that the cabinet air re-circulated to the laboratory is not hindered. A 12–14 inch clearance above the cabinet is required to provide for accurate air velocity measurement across the exhaust filter surface^{25,26} and for exhaust filter changes. When the BSC is hard-ducted (direct-connected) or canopy connected to the ventilation system, adequate space must be provided so that the configuration of the ductwork will not interfere with airflow. The canopy unit must provide adequate access to the exhaust HEPA filter for testing.

The ideal location for the biological safety cabinet is remote from the entry (i.e., the rear of the laboratory away from traffic) since people walking parallel to the face of a BSC can disrupt the air curtain.^{8,16,27} The air curtain created at the front of the cabinet is quite fragile, amounting to a nominal inward and downward velocity of one mph. Open windows, air supply registers, portable fans, or laboratory equipment that creates air movement (e.g., centrifuges, vacuum pumps) should not be located near the BSC. Similarly, chemical fume hoods must not be located close to BSCs.

HEPA Filters HEPA filters, whether part of a building exhaust system or part of a cabinet, will require replacement when they become loaded to the extent that sufficient airflow can no longer be maintained. In most instances, filters must be decontaminated before removal. To contain the decontamination gas or vapor used for microbiological decontamination, exhaust systems containing HEPA filters require airtight dampers to be installed on both the inlet and discharge side of the filter housing. This ensures containment of the gas or vapor inside the filter housing during decontamination. Access panel ports in the filter housing also allow for performance testing of the HEPA filter (Part 7).

A bag-in/bag-out filter assembly^{3,28} (Figure 12) can be used in situations where HEPA filtration is necessary for operations involving biohazardous materials and hazardous or toxic chemicals. The bag-in/bag-out system is used when it is not possible to gas or vapor decontaminate the HEPA filters, or when hazardous chemicals or radionuclides have been used in the BSC, and provides protection against exposure for the maintenance personnel and the environment. A bag-in/bag-out system will require a method to decontaminate or safely dispose of the filter once removed (e.g., a waste service that will decontaminate the filter, or a large enough autoclave). Note, however, that this requirement must be identified at the time of purchase and installation; a bag-in/bag-out assembly cannot be added to a cabinet after-the-fact without an extensive engineering evaluation.

Part 7—Certification of BSCs

Development of Containment Standards

The evolution of containment equipment for varied research and diagnostic applications created the need for consistency in construction and performance. Federal Standard 209²⁹ was developed to establish classes of air cleanliness and methods for monitoring clean workstations and cleanrooms where HEPA filters are used to control airborne particulates. It has since been replaced with ISO 14644-2015.³⁰

The first “standard” to be developed specifically for BSCs¹² served as a Federal procurement specification for the NIH Class II, Type 1 (now called Type A1) BSC, which had a fixed or hinged front window or a vertical sliding sash, vertical downward airflow, and HEPA-filtered supply and exhaust air. This specification

described design criteria and defined prototype tests for microbiological aerosol challenge, velocity profiles, and leak testing of the HEPA filters. A similar procurement specification was generated³¹ when the Class II, Type 2 (now called Type B1) BSC was developed.

NSF/ANSI 49 for Class II BSCs was first published in 1976, providing the first independent standard for design, manufacture, and testing of BSCs. This standard replaced the NIH specifications, which were being used by other institutions and organizations purchasing BSCs. NSF/ANSI 49-2018⁸ incorporates current specifications regarding design, construction, performance, and field certification. This Standard for BSCs establishes performance criteria and provides the minimum testing requirements that are accepted in the United States. Cabinets that meet the Standard and are certified by NSF bear an “NSF” mark.

NSF/ANSI 49-2018 pertains to all models of Class II cabinets (Type A1, A2, B1, B2, C1) and provides a series of specifications regarding:

- Design/construction;
- Performance;
- Installation recommendations; and
- Recommended microbiological decontamination procedures.

References and specifications pertinent to Class II Biosafety Cabinetry, Annex F of NSF/ANSI 49-2018, which covers field testing of BSCs, is a normative part of the Standard. This Standard is reviewed periodically by a committee of experts to ensure that it remains consistent with developing technologies

The operational integrity of a BSC must be validated before it is placed into service and after it has been repaired or relocated. Relocation may break the HEPA filter seals or otherwise damage the filters or the cabinet. Each BSC should be tested and certified at least annually to ensure continued, proper operation.

On-site field certification (NSF/ANSI 49-2018, Annex F) must be performed by experienced, qualified personnel. Some basic information is included in the Standard to assist in understanding the frequency and kinds of tests to be performed. In 1993, NSF began a program for accreditation of certifiers based on written and practical examinations. Education and training programs for persons seeking accreditation as qualified to perform all field certification tests are offered by a variety of organizations. Selecting competent individuals to perform testing and certification is important. It is suggested that the institutional biosafety officer (BSO) or Health and Safety Office be consulted when identifying companies qualified to conduct the necessary field performance tests.

It is strongly recommended that, whenever possible, accredited field certifiers are used to test and certify BSCs. If in-house personnel are performing the certifications, then these individuals should become accredited.

Performance Testing BSCs in the Field

Class II BSCs are the primary containment devices that protect the worker, product, and environment from exposure to microbiological agents. BSC operations, as specified by NSF/ANSI 49-2018, Annex F need to be verified at the time of installation and, as a minimum, annually thereafter. A cabinet should be recertified whenever a HEPA or ULPA filter is replaced, maintenance repairs are made to internal parts, or a cabinet is relocated.

Finally, accurate test results can only be assured when the testing equipment is properly maintained and calibrated. It is appropriate to request the calibration information for the test equipment being used by the certifier.

Table 1. Selection of a Safety Cabinet through Risk Assessment

Biosafety Level	Personnel	Protection Provided	Product	Environmental	BSC Class
BSL-1 to 3	Yes	No		Yes	I
BSL-1 to 3	Yes	Yes		Yes	II (A1, A2, B1, B2)
BSL-4	Yes	Yes		Yes	III; II—when used in suit room with suit

Table 2. Comparison of Biosafety Cabinet Characteristics

BSC Class	Face Velocity	Airflow Pattern	Application: Nonvolatile Toxic Chemicals and Radionuclides	Application: Volatile Toxic Chemicals and Radionuclides
I	75	In at front through HEPA to the outside or into the room through HEPA (Figure 2)	Yes	When exhausted outdoors ^{a,b}
II, A1	75	70% recirculated to the cabinet work area through HEPA; 30% balance can be exhausted through HEPA back into the room or to outside through a canopy unit (Figure 3) ^c	Yes (small amounts) ^b	Yes (small amounts) ^{a,b}
II, B1	100	30% recirculated, 70% exhausted. Exhaust cabinet air must pass through a dedicated, internal cabinet duct to the outside through a HEPA filter (Figures 5a 5b)	Yes	Yes (small amounts) ^{a,b}
I, B2	100	No recirculation; total exhaust to the outside through a HEPA filter (Figure 6)	Yes	Yes (small amounts) ^{a,b}
II, A2	100	Similar to II, A1, but has 100 fpm intake air velocity exhaust air can be ducted to the outside through a canopy unit (Figure 7)	Yes	When exhausted outdoors (formally B3), (small amounts) ^{a,b}
II, C1	100	30% recirculated, 70% exhausted. Exhaust cabinet air must pass through a dedicated, internal cabinet duct to the outside through a blower and HEPA filter	Yes	Yes (small amounts) ^{a,b}
III	N/A	Supply air is HEPA-filtered. Exhaust air passes through two HEPA filters in series and is exhausted to the outside via a hard connection (Figure 8)	Yes	Yes (small amounts) ^{a,b}

- Installation requires a special duct to the outside, and may require an in-line charcoal filter, and/or a spark-proof (explosion-proof) motor and other electrical components in the cabinet. Discharge of a Class I or Class II, Type A2 cabinet into a room should not occur if volatile chemicals are used.
- A risk assessment should be completed by laboratory and safety facility personnel to determine amounts to be used. In all cases, only the smallest amounts of the chemical(s) required for the work to be performed should be used in the BSC. In no instance should the chemical concentration approach the lower explosion limits of the compounds.

- c. Class IIA1 cabinets built prior to 2010 were allowed to have potentially contaminated, positively pressurized plenums. After 2010, All Class II cabinets must have potentially contaminated plenums under negative pressure or surrounded by negatively pressurized plenums.

Figure 1. HEPA Filters

HEPA filters are typically constructed of paper-thin sheets of borosilicate medium, pleated to increase surface area, and affixed to a frame. Aluminum or plastic separators are often added for stability.

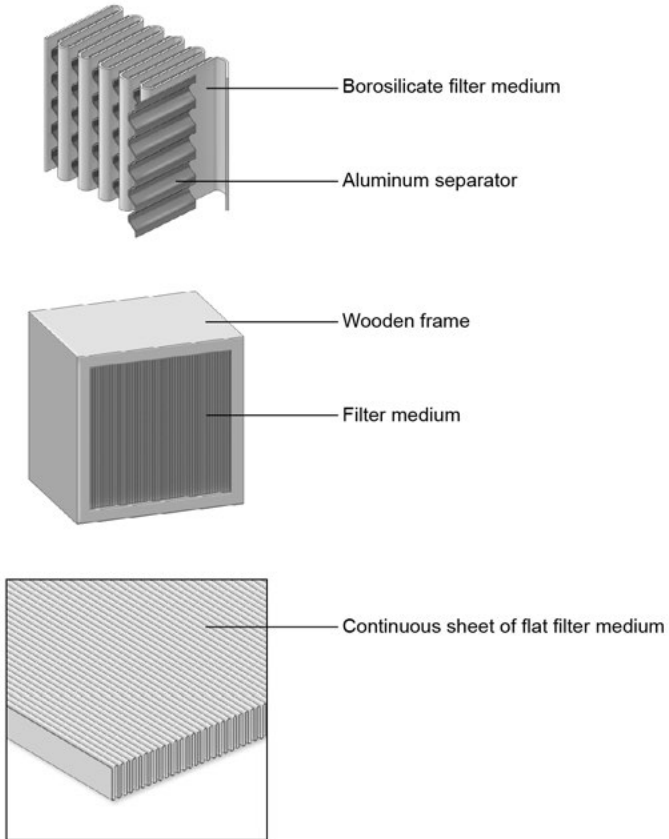

Figure 2. The Class I BSC

(A) front opening; (B) sash; (C) exhaust HEPA filter; (D) exhaust plenum. Note: this classical style cabinet needs to be direct-connected to the building exhaust system.

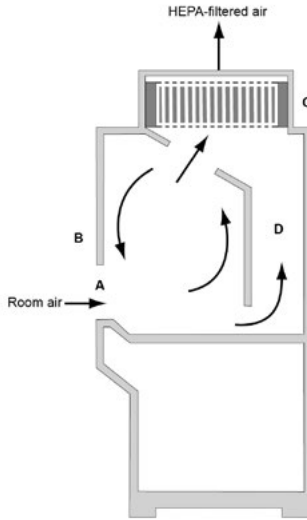

Figure 3. The Class II, Type A BSC

(A) front opening; (B) sash; (C) exhaust HEPA filter; (D) supply HEPA filter; (E) common plenum; (F) exhaust blower. Note: Since 2010 there is minimal difference between the Class II, Type A1 and Class II, Type A2 except for the inflow velocity.

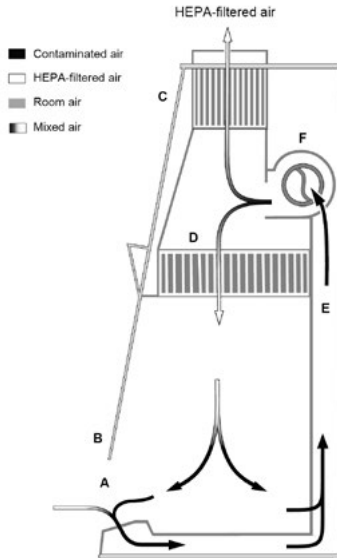

Figure 4. Canopy (thimble) unit for ducting a Class II, Type A BSC

(A) balancing damper; (B) flexible connector to exhaust system; (C) cabinet exhaust HEPA filter housing; (D) canopy unit; (E) BSC. Note: There is a gap between the canopy unit (D) and the exhaust filter housing (C), through which room air is exhausted.

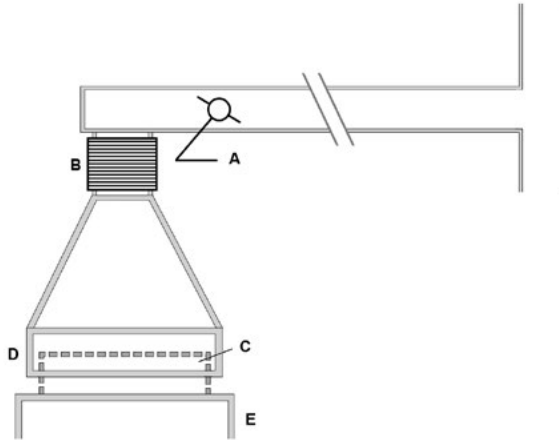

Figure 5a. The Class II, Type B1 BSC (classic design)

(A) front opening; (B) sash; (C) exhaust HEPA filter; (D) supply HEPA filter; (E) negative pressure dedicated exhaust plenum; (F) blower; (G) additional HEPA filter for supply air. Note: The cabinet exhaust needs to be direct-connected to the building exhaust system.

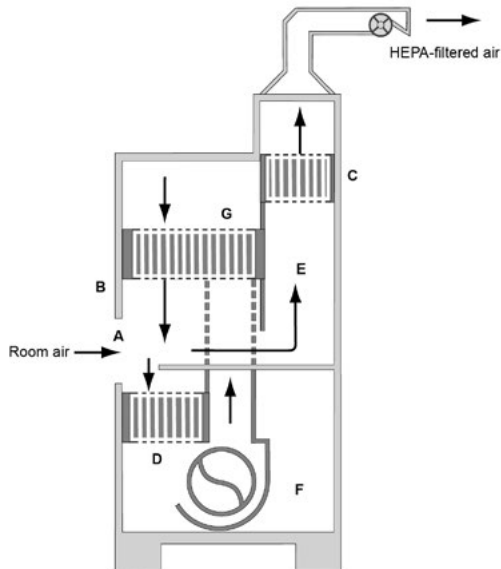

Figure 5b. The Class II, Type B1 BSC (benchtop design)

(A) front opening; (B) sash; (C) exhaust HEPA filter; (D) supply plenum; (E) supply HEPA filter; (F) blower; (G) negative pressure exhaust plenum. Note: The cabinet exhaust needs to be direct-connected to the building exhaust system.

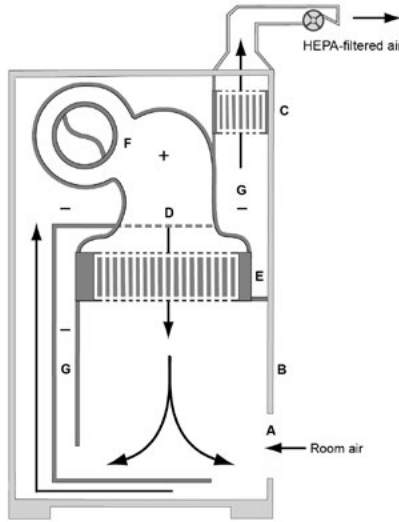

Figure 6. The Class II, Type B2 BSC

(A) front opening; (B) sash; (C) exhaust HEPA filter; (D) supply HEPA filter; (E) negative pressure exhaust plenum. Note: The cabinet needs to be direct-connected to the building exhaust system.

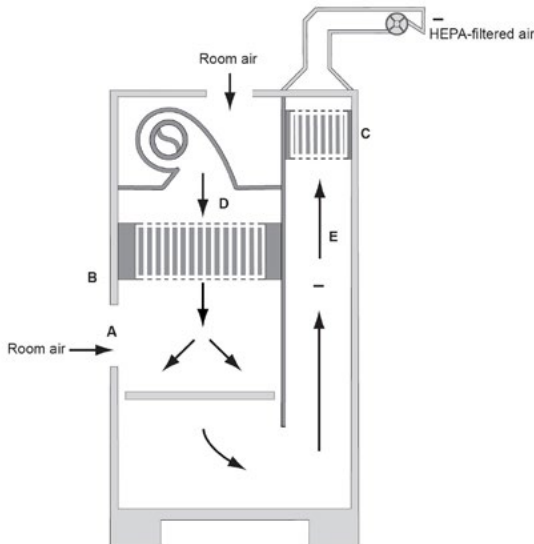

Figure 7a. The Class II, Type C1 BSC (not connected to building exhaust system)

(A) front opening; (B) sash; (C) exhaust HEPA filter; (D) supply filter; (E) supply blower; (F) exhaust blower.

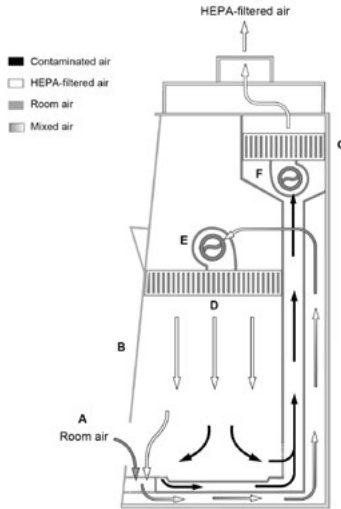

Figure 7b. The Class II, Type C1 BSC (connected to building exhaust system)

(A) front opening; (B) sash; (C) exhaust HEPA filter; (D) supply HEPA filter; (E) supply blower; (F) exhaust blower; (G) balancing damper; (H) sealed flexible duct (optional); (I) canopy opening/gap; (J) exhaust duct.

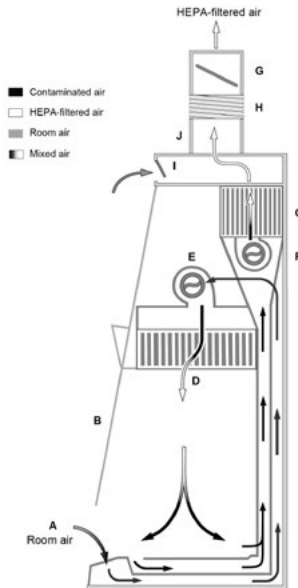

Figure 8. The Class III BSC

(A) glove ports with O-ring for attaching arm-length gloves to cabinet; (B) window; (C) exhaust HEPA filter; (D) supply HEPA filter; (E) double-ended autoclave or pass-through box; (F) exhaust HEPA filter. Note: A chemical dunk tank may be installed, which would be located beneath the work surface of the BSC with access from above. The cabinet exhaust needs to be direct-connected to an exhaust system where the fan is separate from the exhaust fans of the facility ventilation system. The exhaust air must be double HEPA-filtered or HEPA-filtered and incinerated.

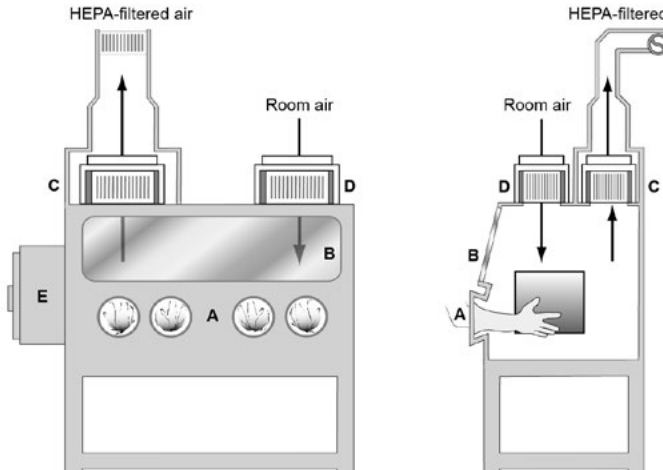

Figure 9a. The Horizontal Laminar flow Clean Bench

(A) front opening; (B) supply grille; (C) supply HEPA filter; (D) supply plenum; (E) blower.

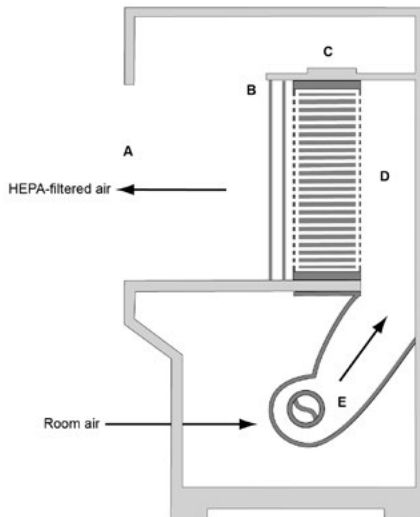

Figure 9b. The Vertical Laminar Flow Clean Bench

(A) front opening; (B) sash; (C) supply HEPA filter; (D) blower. Note: Some vertical flow clean benches have recirculated air through front and/or rear grilles.

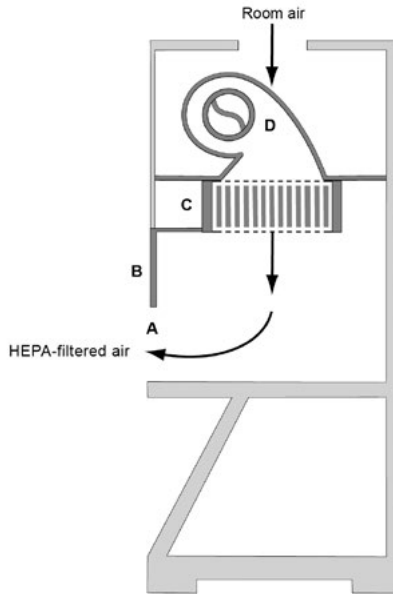

Figure 10. Clean to Dirty

A typical layout for working from the clean to the dirty side within a Class II BSC. Clean cultures (left) can be inoculated (center); contaminated pipettes can be discarded in the shallow pan and other contaminated materials can be placed in the biohazard bag (right). This arrangement is reversed for left-handed persons.

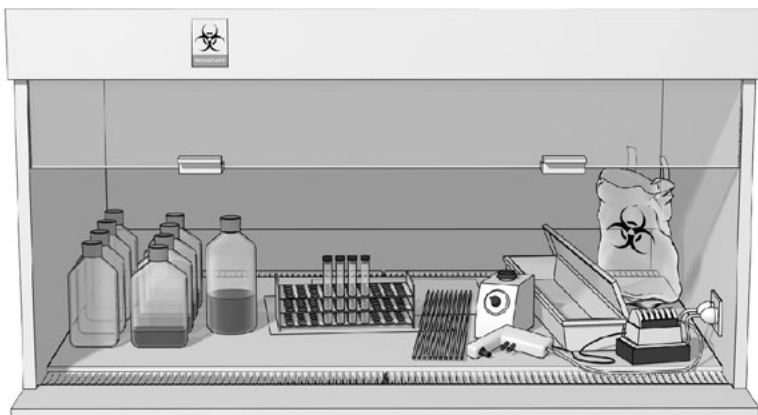

Figure 11. Protection of a house vacuum

Example method to protect a house vacuum system during aspiration of infectious fluids. The suction flask (A) is used to collect the contaminated fluids into a suitable decontamination solution; the right flask (B) serves as a fluid overflow collection vessel. An in-line HEPA filter (C) is used to protect the vacuum system (D) from aerosolized microorganisms.

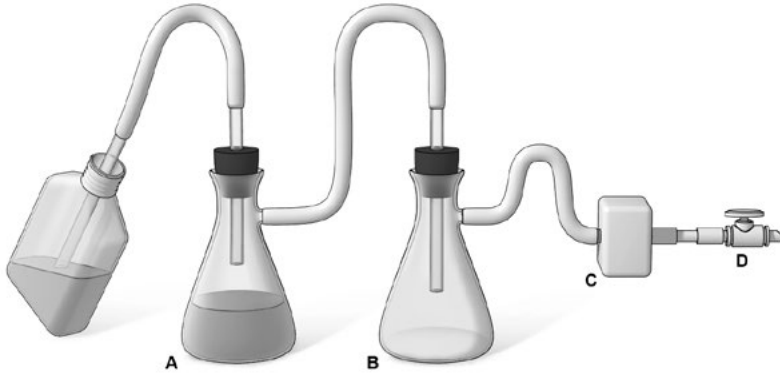
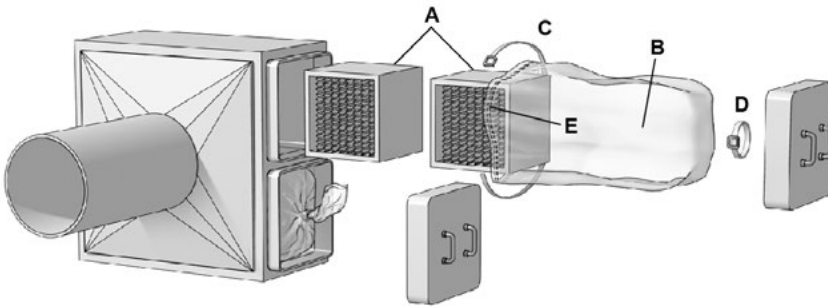

Figure 12. Bag-in/bag-out filter enclosure

A bag-in/bag-out filter enclosure allows for the removal of the contaminated filter without worker exposure. (A) filters; (B) bags; (C) safety straps; (D) cinching straps; (E) shock cord located in the mouth of the PVC bag restricts the bag around the second rib of the housing lip.



Acknowledgments

We gratefully acknowledge the Baker Company; Filtration Group, Inc.; Flanders Filters; and Forma Scientific, Inc., for use of some drawings and figures reproduced herein.

References

1. Kruse RH, Puckett WH, Richardson JH. Biological safety cabinetry. *Clin Microbiol Rev.* 1991;4(2):207–41.
2. HEPA and ULPA Filters, IEST-RP-CC001 (2016).
3. First MW. Filters, high capacity filters and high-efficiency filters: review and production. In: *Place Filter Testing Workshop*; 1971; Boston, Massachusetts.
4. Dow Chemical U.S.A.; National Cancer Institute. *A Workshop for Certification of Biological Safety Cabinets*. No. BH 74-01-11. Midland (MI): Dow Chemical U.S.A.; 1974.
5. Richmond JY. Safe practices and procedures for working with human specimens in biomedical research laboratories. *J Clin Immunoassay.* 1988;13:115–9.
6. Barbeito MS, Taylor LA. Containment of microbial aerosols in a microbiological safety cabinet. *Appl Microbiol.* 1968;16(8):1255–9.
7. Whitfield WJ. *A new approach to cleanroom design*. Albuquerque (NM): Sandia Corporation; 1962.
8. NSF International (NSF); American National Standards Institute (ANSI). *NSF/ANSI 49-2018. Biosafety Cabinetry: Design, Construction, Performance, and Field Certification*. Ann Arbor (MI): NSF/ANSI; 2018.
9. Jones RL Jr, Tepper B, Greenier TG, Stuart DG, Large S, Eagleson D. Effects of Thimble Connections of Biological Safety Cabinets. *Abstracts of 32nd Biological Safety Conference*; 1989; New Orleans, LA.
10. *Guidelines for Cytotoxic (Antineoplastic) Drugs*. Standard 01-23-001, Appendix A (1986).
11. Centers for Disease Control and Prevention; National Institute for Occupational Safety and Health. *NIOSH Alert: Preventing Occupational Exposures to Antineoplastic and Other Hazardous Drugs in Health Care Settings*. Cincinnati (OH): NIOSH—Publications Dissemination; 2004.
12. Stuart DG, First MW, Jones RL Jr, Eagleson JM Jr. Comparison of chemical vapor handling by three types of class II biological safety cabinets. *Particulate and Microbial Control*. 1983.
13. Stuart D, Kiley M, Ghidoni D, Zarembo M. The Class III Biological Safety Cabinet. In: Richmond JY, editor. *Anthology of Biosafety VII: Biosafety Level 3*. Mundelein (IL): American Biological Safety Association; 2004. p. 57–71.
14. American Conference of Governmental Industrial Hygienists (ACGIH). *Threshold limit values for chemical substances and physical agents and biological exposure indices*. Cincinnati (OH): ACGIH; 2006.

15. National Institutes of Health. NIH guidelines for the laboratory use of chemical carcinogens. Washington (DC): U.S. Department of Health & Human Services; 1981.
16. National Cancer Institute; Office of Research Safety. Laboratory safety monograph: a supplement to the NIH guidelines for recombinant DNA research. Bethesda (MD): National Institutes of Health; 1978.
17. Office of Research Safety; National Cancer Institute. National Cancer Institute Safety Standards for Research Involving Chemical Carcinogens. Bethesda (MD): The National Institutes of Health; 1975.
18. Jones R, Drake J, Eagleson D. Using Hydrogen Peroxide Vapor to Decontaminate Biological Safety Cabinets. Baker [Internet]. 1993 [cited 2019 Mar 11];1(1):[about 4 p.] Available from: <https://bakerco.com/communication/white-papers/>
19. Jones R, Stuart D, Large S, Ghidoni D. Cycle Parameters for Decontaminating a Biological Safety Cabinet Using H₂O₂ Vapor. Baker [Internet]. 1993 [cited 2019 Mar 11];1(2):[about 4 p.] Available from: <https://bakerco.com/communication/white-papers/>
20. Jones R, Stuart D, PhD, Large S, Ghidoni D. Decontamination of a HEPA filter using hydrogen peroxide vapor. *Acumen*. 1993;1(3):1–4.
21. Fox D, editor. Proceedings of the National Cancer Institute symposium on design of biomedical research facilities. Monograph Series. Vol 4; 1979 Oct 18–19; Frederick, MD. Litton Bionetics, Inc.; 1979.
22. Laboratories. In: American Society of Heating, Refrigerating and Air-Conditioning Engineers. 2015 ASHRAE Handbook—HVAC Applications. Atlanta (GA): ASHRAE; 2015.
23. Agricultural Research Service (ARS) [Internet]. Beltsville (MD): United States Department of Agriculture; c2012 [cited 2019 Mar 12]. ARS Facilities Design Standards. ARS—242.1. Available from: <https://www.afm.ars.usda.gov/ppweb/pdf/242-01m.pdf>
24. American Conference of Governmental Industrial Hygienists (ACGIH). Industrial Ventilation: A Manual of Recommended Practice for Design. 28th ed. Cincinnati (OH): ACGIH; 2015.
25. Jones RL Jr, Stuart DG, Eagleson D, Greenier TJ, Eagleson JM Jr. The effects of changing intake and supply air flow on biological safety cabinet performance. *Appl Occup Environ Hyg*. 1990;5(6):370–7.
26. Jones RL Jr, Stuart DG, Eagleson, D, et al. Effects of ceiling height on determining calculated intake air velocities for biological safety cabinets. *Appl Occup Environ Hyg*. 1991;6(8):683–8.

27. Rake BW. Influence of crossdrafts on the performance of a biological safety cabinet. *Appl Environ Microbiol.* 1978;36(2):278–83.
28. Barbeito MS, West DL, editors. Laboratory ventilation for hazard control. *Proceedings of a 1976 Cancer Research Safety Symposium*; 1976 Oct 21–22; Frederick, MD. Frederick (MD): Frederick Cancer Research Center; 1976.
29. Airborne Particulate Cleanliness Classes in Clean rooms and Clean Zones, Federal Standard No. 209 (1963).
30. Cleanrooms and associated controlled environments—Part 1: Classification of air cleanliness by particle concentration, ISO 14644-1 (2015).
31. National Cancer Institute. Specifications for general purpose clean air biological safety cabinet. Bethesda (MD): National Institutes of Health; 1973.

Appendix B—Decontamination and Disinfection of Laboratory Surfaces and Items

Purpose and Scope

Appendix B provides basic guidance for the decontamination or disinfection of environmental surfaces and items in the laboratory with antimicrobial substances and other practices to mitigate the possibility of transmission of pathogens to laboratory workers, the public, and the environment. The selection of an appropriate antimicrobial product and adherence to the product label instructions are critical to ensuring the product's performance against the target microorganism. Regulatory oversight, terminology, factors necessary for environmentally-mediated transmission of infection (e.g., aerosol generation, contact, indirect contact), methods for sterilization and disinfection, and the levels of antimicrobial activity associated with liquid chemical disinfectants are reviewed in this appendix. One must remember that aerosol-generating procedures should be conducted in containment. Accidents involving infectious aerosols have been a source of contamination within the laboratory setting and may impact the method chosen for decontamination. General approaches are emphasized instead of detailed protocols and methods. It is important to follow the manufacturer's instructions for use when performing decontamination practices in the laboratory.

Antimicrobial Products—U.S. Regulations

Antimicrobial pesticides (e.g., disinfectants) are classified as pesticides and are regulated by both the United States Environmental Protection Agency under the authority of the Federal Insecticide, Fungicide, and Rodenticide Act (FIFRA)^{1,2} and the United States Food and Drug Administration, Center for Devices and Radiologic Health by the Food Quality Protection Act (FQPA).³ The laboratory is responsible for selecting an appropriate EPA-registered product and using it according to the manufacturer's instructions on the product label. The more commonly used public health antimicrobial products are described in the Glossary (e.g., sporicides, disinfectants, and sanitizers). The lists of selected EPA-registered disinfectants are available at <https://www.epa.gov/oppad001/chemregindex.htm>.

The FDA has defined three types of liquid chemical germicides for processing medical devices, and these germicides are regulated as auxiliary devices (FDA 1977 Policy Manual): (1) sterilant/high-level disinfectant; (2) intermediate-level disinfectant; and (3) low-level disinfectant. See Glossary.

Disinfectants used in the laboratory include those recommended by equipment manufacturers and a broad-spectrum product, typically an intermediate-level disinfectant (i.e., a product with a mycobacteriology claim). Safe use of chemicals within the laboratory falls under the OSHA Laboratory Standard.⁴

Environmentally-Mediated Transmission of Infection

Laboratory-associated infections (LAIs) can be transmitted directly or indirectly from contaminated environmental sources within the laboratory (e.g., air, fomites and laboratory instruments, aerosols, and splashes) to laboratory staff. Fortunately, LAIs are relatively rare events because there are several requirements necessary for environmental transmission to occur;^{5,6} this is commonly referred to as the chain of infection.^{7,8} The requirements needed for environmental transmission include the presence of a pathogen of sufficient virulence, sufficient dose of a pathogen to cause infection (i.e., infectious dose), a mechanism of transmission of the pathogen from the environment to the host, the correct portal of entry to a susceptible host, and the immune status of the host.

To accomplish successful transmission from an environmental source, all the requirements for the chain of infection must be present. The absence of any one element will reduce and/or prevent the potential for transmission. Additionally, the pathogen in question must overcome environmental stresses to retain viability (e.g., ability to form biofilms in low, nutrient-moist environments or distribution systems, ability to survive dehydration), virulence, and the capability to initiate infection in the host. In the laboratory setting, high concentrations of pathogens are commonplace, and contamination of environmental surfaces (e.g., benchtops, equipment, personal protective equipment) and hands of the laboratorian may occur. Aerosol generation procedures and those that generate splashes may also contaminate surfaces, personnel, and potentially expose workers (e.g., inhalation, contact with mucous membranes) to pathogens. Reduction of environmental microbial contamination by both containment (e.g., performing aerosol-generating procedures in a biological safety cabinet or glove box) and conventional cleaning procedures is often enough to reduce, but not eliminate, the risk of environmentally-mediated transmission. It is the general practice in laboratories to use both cleaning and surface disinfection or sterilization procedures to mitigate the potential for transmission of infection. In addition, proper hand hygiene and appropriate personal protective equipment (e.g., gloves, lab coat/smock, safety glasses, goggles, respirators) use are also important factors in preventing transmission to laboratory personnel.

Principles of Cleaning, Disinfection, and Sterilization

To implement a laboratory biosafety program, it is important to understand the principles of cleaning and disinfection or sterilization. The terms are often misused and misunderstood. The definitions and capabilities of each inactivation procedure are discussed with an emphasis on achievement and, in some cases, monitoring of each state.

Cleaning Cleaning is the removal of gross contamination from a surface to the extent necessary for further processing for intended use. In these cases, cleaning

can be used to remove microorganisms and other associated contaminants (e.g., blood, tissues, culture media) from a surface by physical means but may not provide any antimicrobial activity. Cleaning is often an essential pre-requisite to disinfection or sterilization processes to ensure the optimal activity of the antimicrobial effects of disinfectants or sterilization processes. Biofilms may be present in the laboratory (e.g., sinks, plumbing fixtures, fluid-filled lines of laboratory equipment, water containing reservoirs, incubator humidification systems) and are often difficult to treat/disinfect. Most biofilms require physical cleaning (e.g., scrubbing) and the use of compatible oxidative disinfectants (e.g., chlorine dioxide, peroxyacetic acid, ozone). In some situations, replacing tubing and distribution lines may be necessary.

Disinfection Disinfection is generally a less-lethal process than sterilization; it eliminates nearly all recognized pathogenic microorganisms, but not necessarily all microbial forms (e.g., bacterial spores) present on inanimate objects. Disinfection does not ensure a kill level and lacks the margin of safety achieved by sterilization procedures. The effectiveness of a disinfection procedure is controlled by several factors, each one of which may have a pronounced effect on the end results. Factors affecting disinfection include the following:

1. Nature and number of contaminating microorganisms (especially the presence of bacterial spores);
2. Amount of organic matter present (e.g., soil, feces, blood);
3. Type and condition of surfaces, instruments, devices, and materials to be disinfected;
4. Temperature; and
5. Contact (exposure) time.

By definition, chemical disinfection, especially high-level disinfection, differs from chemical sterilization by the lack of sporicidal power. This is an over-simplification of reality because a few chemical disinfectants do kill large numbers of spores even though high concentrations and several hours of exposure may be required. Non-sporicidal disinfectants may differ in their capacity to accomplish disinfection or decontamination. Some disinfectants rapidly kill only the ordinary vegetative forms of bacteria, such as staphylococci and streptococci, some forms of fungi, and lipid-containing viruses; others are effective against such relatively resistant organisms as *Mycobacterium bovis* or *Mycobacterium terrae*, non-enveloped viruses, and most forms of fungi.⁹

In general, most laboratories use a disinfectant that has a broad range of activity; thus, most labs should select a product with a tuberculocidal/mycobactericidal claim for routine purposes. Many of these products will also have claims that meet the OSHA Bloodborne Pathogens Standard.^{10,11}

Sterilization Any item, device, or solution is sterile when it is completely free of all forms of living microorganisms, including spores and viruses. This definition is categorical and absolute; an item is either sterile or it is not. Sterilization can be accomplished by dry or moist heat, gases and vapors (e.g., chlorine dioxide, ethylene oxide, formaldehyde, hydrogen peroxide, methyl bromide, nitrogen dioxide, ozone, propylene oxide), plasma sterilization technology, and radiation (e.g., gamma, e-beam in industry).

From an operational standpoint, a sterilization procedure cannot be categorically defined because the likelihood that an individual microorganism survives is never zero. Rather, the procedure is defined as a process, after which the probability of a microorganism surviving on an item subjected to treatment is less than one in one million. This is referred to as a sterility assurance level (SAL) of 10^{-6} .^{12–14} Laboratories use sterilization techniques for producing media, sterilizing glassware, and other items, and for decontaminating waste.

Decontamination

Decontamination renders an area, device, item, or material safe to handle in the context of being reasonably free from a risk of disease transmission. The primary objective of decontamination is to reduce the level of microbial contamination so that transmission of infection is prevented. The decontamination process may involve the cleaning of an instrument, device, or area with ordinary soap and water. In laboratory settings, decontamination of items, used laboratory materials, and regulated laboratory wastes is often accomplished by a sterilization procedure such as steam autoclaving, which may be the most cost-effective way to decontaminate a device or an item.

The presence of any organic matter necessitates longer contact time with a decontamination method if the item or area is not pre-cleaned. For example, a steam cycle used to sterilize pre-cleaned items can be 20 minutes at 121°C. When steam sterilization is used to decontaminate laboratory waste that contains items that have a high bio-burden and there is no pre-cleaning (i.e., infectious waste), the cycle times are generally longer and should be verified and validated for the typical load. Validation involves the combined use of thermocouples and biological indicators (BIs) placed throughout the load to ensure penetration of steam into the waste. Verification can be accomplished by routine monitoring of the steam sterilization cycles (i.e., cycle times, pressure, temperature) and by placing BIs within the load.¹⁵ In addition to time, temperature may also be increased to ensure inactivation of pathogens.^{16–18} Decontamination in laboratory settings often requires longer exposure times because pathogenic microorganisms may be protected from contact with steam.

Chemical disinfectants used for decontamination range in activity from high-level disinfectants (e.g., high concentrations of sodium hypochlorite [chlorine bleach]),

which might be used to decontaminate spills of cultured or concentrated infectious agents in research or clinical laboratories, to low-level disinfectants or sanitizers for general housekeeping purposes or spot decontamination of environmental surfaces in healthcare settings. Resistance of selected organisms to decontamination is presented in descending order in Figure 1. If dangerous and highly infectious agents are present in a laboratory, the methods for decontamination of spills, laboratory equipment, biological safety cabinet, or infectious waste are very significant and may include prolonged autoclave cycles, incineration, or gaseous treatment of surfaces.

Figure 1. Descending Order of Relative Resistance to Disinfectant Chemicals

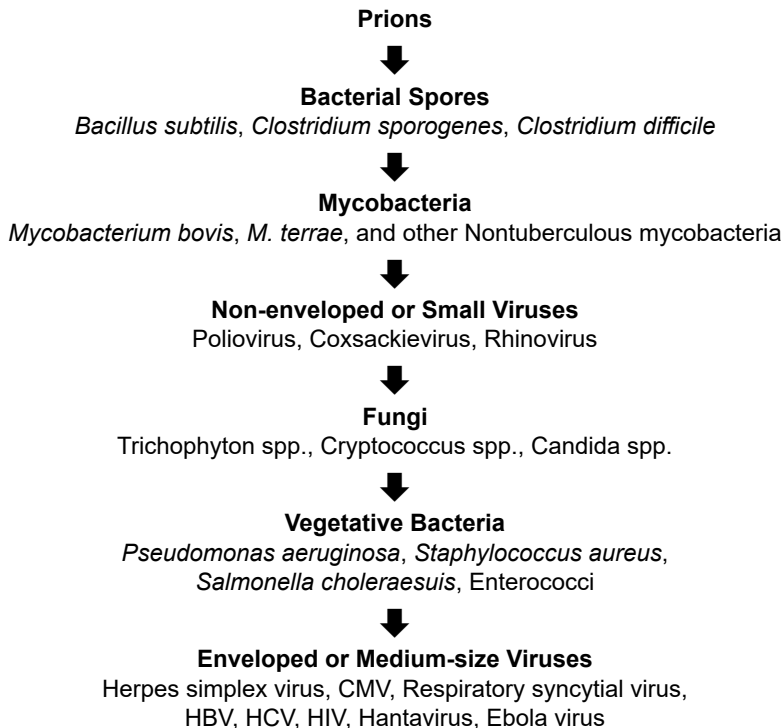

Note: There are exceptions to this list. *Pseudomonas* spp. are sensitive to high-level disinfectants. However, in biofilms, the protected cells and those within free-living amoeba, or existing as persister cells (viable but not culturable) within the biofilm, can approach the resistance of bacterial spores to the same disinfectant. The same is true for the resistance to glutaraldehyde by some nontuberculous mycobacteria, some fungal ascospores of *Microascus cinereus* and *Chaetomium globosum*, and the pink-pigmented Methylobacteria. Prions are also resistant to most liquid chemical germicides and are discussed in the last part of this appendix.

Space Decontamination Space decontamination is a specialized activity and should be performed by individuals with proper expertise, training, and personal protective equipment.^{19–24} Decontamination requirements for laboratory spaces influence the design of these facilities. The interior surfaces of laboratories must be easy to clean and decontaminate. Penetrations in BSL-3 laboratory surfaces should be sealed or capable of being sealed for decontamination purposes. Care should be taken that penetrations in the walls, floors, and ceilings are kept to a minimum and are sight sealed. Verification of the seals is highly recommended but is usually not required for BSL-3 laboratories. The BSL-4 laboratory design requires interior surfaces that are water-resistant and sealed to facilitate fumigation. Periodic fumigation is required in the BSL-4 suit laboratory to allow routine maintenance and certification of equipment.

Procedures for decontamination of large spaces such as incubators or rooms are varied and influenced significantly by the type of etiologic agent involved, the characteristics of the structure containing the space, and the materials present in the space. The primary methods for space decontamination follow. Fumigants that are currently used are either gases, vapors, mists, or fogs (dry mists). Fumigants that are gases obey gas laws, can evenly distribute throughout the room, and are easily scalable by increasing the volume of gases used. Fumigants applied as mists or fogs do not behave like gases and are particles (<1–12 μ in size) that settle onto surfaces being treated.

Paraformaldehyde and Formaldehyde Gas

Paraformaldehyde and solutions of formaldehyde have been used to generate formaldehyde gas and mists; historically, they have been used in laboratory settings for decontamination of large spaces and biological safety cabinets.^{25,26} When using formaldehyde and paraformaldehyde, take safety precautions,^{27,28} federal regulations, state regulations, and local regulations into consideration.²⁹ Formaldehyde is also recognized as a known human carcinogen.³⁰ There is at least one EPA-registered paraformaldehyde product available for the decontamination of laboratories. It is important that paraformaldehyde is used per labeling instructions and that a fumigation management and safety plan that meets federal, state, and local regulations is prepared in advance of application and is implemented during application. For use as a space decontamination agent, the standard concentration of formaldehyde is 0.3g/ft³ (approximately 8,000 ppm) with a relative humidity of between 60 and 85%.³¹ Increasing the amount of paraformaldehyde is not advised, as the lower explosive limit for formaldehyde gas is 7% (70,000 ppm).³² It is recommended that formaldehyde gas decontamination be performed only by highly experienced individuals.

Hydrogen Peroxide Vapor

Hydrogen peroxide can be vaporized and used for the decontamination of glove boxes and small room areas. Vapor phase hydrogen peroxide has been shown to be an effective sporicide at concentrations ranging from 0.5 mg/L to <10 mg/L. The optimal concentration of this agent is about 2.4 mg/L with a contact time of at least one hour. This system can be used to decontaminate glove boxes, walk-in incubators, and small rooms. An advantage of this system is that the end products (i.e., water and oxygen) are not toxic. Low relative humidity can be used.^{33–36}

Chlorine Dioxide Gas

Chlorine dioxide gas sterilization can be used for decontamination of laboratory rooms, equipment, glove boxes, and incubators. The concentration of gas at the site of decontamination should be approximately 10 mg/L with a contact time of one to two hours.^{37–40}

Chlorine dioxide possesses the bactericidal, virucidal, and sporicidal properties of chlorine, but unlike chlorine, it does not lead to the formation of trihalomethanes and does not combine with ammonia to form chlorinated organic products (chloramines). The gas cannot be compressed and stored in high-pressure cylinders, but it is generated upon demand using a column-based solid-phase generation system. Gas is diluted to the use concentration, usually between 10 and 30 mg/L. Within reasonable limits, a chlorine dioxide gas generation system is unaffected by the size or location of the ultimate destination for the gas. Relative humidity does need to be controlled and high humidity is optimal. Although most often used in closed sterilizers, the destination enclosure for the chlorine dioxide gas does not need to be such a chamber. Because chlorine dioxide gas exits the generator at a modest positive pressure and flow rate, the enclosure also need not be evacuated and could be a sterility-testing isolator, a glove box or sealed BSC, or even a small room that could be sealed to prevent gas egress.⁴⁰ Chlorine dioxide gas is rapidly broken down by light; care must be taken to eliminate light sources in spaces to be decontaminated.

Decontamination of Surfaces Liquid chemical disinfectants may be used for decontamination of large surface areas. The usual procedure is to flood the area with a disinfectant for periods up to several hours. This approach is messy, and some of the disinfectants used represent a toxic hazard to laboratory staff. For example, most of the high-level disinfectants on the United States market are formulated for use on instruments and medical devices rather than on environmental surfaces. Intermediate and low-level disinfectants are formulated for use on fomites and environmental surfaces but lack the potency of high-level disinfectants. For the most part, intermediate and low-level disinfectants can be safely used and, as with all EPA-registered disinfectants, the manufacturer's instructions

should be followed.⁴¹ Disinfectants that have been used for decontamination include: sodium hypochlorite solutions at concentrations of 500 to 6000 parts per million (ppm); oxidative disinfectants, such as hydrogen peroxide and peracetic acid; phenols; and iodophors. Procedures for the use of chemical disinfectants should include safety precautions, the use of appropriate personal protective equipment, hazard communication, and training on spill response.

Concentrations and exposure times vary depending on the disinfectant formulation and the manufacturer’s instructions for use. See Table 1 for a list of chemical disinfectants and their activity levels. A spill control plan must be available in the laboratory. This plan should include the rationale for selection of the disinfectant, the approach to its application, contact time, and other parameters. Biological agents requiring BSL-3 and BSL-4 containment pose a high risk to workers and possibly to the environment, and these agents should be managed by trained, professional staff who are equipped to work with concentrated material.

Table 1. Activity Levels of Selected Liquid Chemical Disinfectants

Chemical^a	Concentration	Activity level
Glutaraldehyde	Variable	Sterilization
Glutaraldehyde	Variable	Intermediate to high-level disinfection
Ortho-phthalaldehyde (OPA)	0.55%	High-level disinfection
Hydrogen peroxide	6–30%	Sterilization
Hydrogen peroxide	3–6%	Intermediate to high-level disinfection
Formaldehyde^b	6–8%	Sterilization
Formaldehyde	1–8%	Low- to high-level disinfection
Chlorine dioxide	Variable	Sterilization
Chlorine dioxide	Variable	High-level disinfection
Peracetic Acid	0.08%–0.23% with peroxide concentrations of 1–7.35%	Sterilization
Peracetic acid	Variable	High-level disinfection
Hypochlorites^c	500–6000 mg/L Free available	Intermediate to high-level disinfection
Alcohols (ethyl, isopropyl)^d	70%	Intermediate-level disinfection
Phenolics	0.5–3%	Low- to intermediate-level disinfection

Continued on next page ►

Chemical ^a	Concentration	Activity level
Iodophors ^e	30–50 mg/L Free	Low- to intermediate-level disinfection
Quaternary Ammonium Compounds	Variable	Low-level disinfection

- a. This list of chemical disinfectants centers on generic formulations. A large number of commercial products based on these generic components can be considered for use. Users should ensure that commercial formulations are registered with EPA or by the FDA. Users can search for EPA-registered products at <https://www.epa.gov/pesticide-labels>.
- b. Because formaldehyde is classified as a known human carcinogen and has a low permissible exposure limit (PEL), the use of formaldehyde is limited to certain specific circumstances under carefully controlled conditions (e.g., for the disinfection of certain hemodialysis equipment). There are no FDA-cleared liquid chemical sterilant/disinfectants that contain formaldehyde.
- c. Generic disinfectants containing chlorine are available in liquid or solid form (e.g., sodium or calcium hypochlorite). The indicated concentrations are rapid-acting and broad-spectrum (i.e., tuberculocidal, bactericidal, fungicidal, and virucidal). Note: Common household bleach is an excellent and inexpensive source of sodium hypochlorite. Concentrations between 500 and 1000 ppm chlorine are appropriate for the vast majority of uses requiring an intermediate-level of germicidal activity; higher concentrations are extremely corrosive as well as irritating to personnel, and their use should be limited to situations where there may be spores or there is an excessive amount of organic material or unusually high concentrations of microorganisms (e.g., spills of cultured material in the laboratory). In situations where there is an excessive amount of organic material present, the surfaces should be thoroughly cleaned to remove as much organic material as possible before applying sodium hypochlorite solution to disinfect the surface (see product label instructions). The concentration of the sodium hypochlorite should be determined in advance of use and the solution should be made fresh each day.
- d. The effectiveness of alcohols as intermediate-level germicides is limited because they evaporate rapidly, resulting in short contact times, and because they lack the ability to penetrate residual organic material. They are rapidly tuberculocidal, bactericidal, and fungicidal, but may vary in spectrum of virucidal activity. Items to be disinfected with alcohols should be carefully pre-cleaned then totally submerged for an appropriate exposure time.
- e. Only those iodophors registered with EPA as hard-surface disinfectants should be used, closely following the manufacturer's instructions regarding proper dilution and product stability. Antiseptic iodophors are not suitable to disinfect devices, environmental surfaces, or medical instruments.

Transmissible Spongiform Encephalopathy Agents (Prions) Prions are exceptionally difficult to inactivate and decontaminate and are the causative agent of Creutzfeldt-Jakob disease (CJD) and other transmissible spongiform encephalopathies of the central nervous system in humans or animals. Studies show that prions are resistant to conventional uses of heat and/or chemical germicides for the sterilization of instruments and devices.^{12,42,43} Treatment of tissues and contaminated tissues is based on tissue infectivity.⁴⁴ See [Section VIII-H: Prion Diseases](#) for additional information.

Inactivation of Select Agents Select agents can be inactivated using conventional disinfection and sterilization procedures appropriate to the type of agent (e.g., virus, spore-forming bacteria). Inactivation procedures typically leave cell components intact that can then be used as reagents for assay development or other studies while the purpose of disinfection is to kill and damage pathogens with no attention to preserve cell components. Once inactivated, the agents are no longer subject to the Select Agent Regulations. Problems have arisen when spore-forming Select Agents such as *Bacillus anthracis* have not been completely inactivated. This was highlighted in 2015 when irradiated spores were shipped to non-select, agent-approved laboratories but were later found to be only partially inactivated.⁴⁵ The Select Agent Regulations require that the inactivation process

used for these agents be validated. Select Agent guidance is available at https://www.selectagents.gov/resources/Inactivation_Guidance.pdf and at https://www.selectagents.gov/resources/Biosafety_Guidance.pdf.

Chemical Safety When using chemical agents for decontamination, pay attention to instructions for their use and Safety Data Sheets (SDS); ensure they are used safely and that appropriate precautions and protections are used. Exposures to disinfectants have resulted in occupational injuries such as cancer, hypersensitivities, dermatitis, and asthma.^{46,47}

Hand Hygiene Handwashing and hand decontamination are an underappreciated part of risk mitigation for handling pathogens. Gloves should be worn when handling biohazardous materials and hazardous chemicals, including those used in disinfection and decontamination; this does not replace the need for regular hand hygiene by laboratory personnel.⁴⁸ Hand hygiene should be performed after removing gloves, after touching potentially contaminated surfaces with bare hands, after completing work, and before exiting the laboratory. The main method of hand hygiene in the laboratory is handwashing with soap and water.

When handwashing facilities are not available, an alcohol-based hand sanitizer (ABHS) with an alcohol concentration between 60–95% may be used in conjunction with or in lieu of immediate handwashing, based on agent type and a risk assessment that accounts for potential reduced efficacy of hand sanitizers for soiled hands and inactivating some microorganisms (i.e., bacterial spores, parasites, and non-enveloped viruses). ABHS may be used for immediate hand hygiene until a handwashing facility can be accessed only if hands are not grossly contaminated. The limitations of ABHS should be communicated to staff. Handwashing with soap and water remains the preferred method of performing hand hygiene.⁴⁹ ABHS should be applied to cover the skin and nails (including underneath the nail) of the hands for 20–30 seconds. Posters are available to assist in demonstrating the proper method of hand sanitizing using ABHS at <https://www.cdc.gov/features/handhygiene>.

If hands are grossly contaminated when exiting the laboratory, they should be washed with soap or soap containing an antiseptic agent (i.e., antimicrobial soap) and water.^{49,50} When using soap and water, the entire procedure should last 40–60 seconds from wetting hands to drying with a paper towel. Posters are available to assist in demonstrating the proper method of handwashing at <https://www.cdc.gov/handwashing/posters.html>. Posters are available to assist in demonstrating the proper method of handwashing and use of an ABHS at <https://www.who.int/gpsc/tools/GPSC-HandRub-Wash.pdf>.

References

1. Environmental Protection Agency. Pesticide Labeling and Other Regulatory Revisions, Final Rule (40 C.F.R. Parts 152 and 156). Fed Regist. 2001;66(241):64759–68.
2. Environmental Protection Agency. Data Requirements for Antimicrobial Pesticides, Final Rule (40 C.F.R. Parts 158 and 161). Fed Regist. 2013;78(89):26936–93.
3. Food Quality Protection Act of 1996, Pub. L. No. 104-70, 104 Stat. 1627 (August 3, 1996).
4. Occupational Safety and Health Administration. Laboratory safety guidance Washington (DC): U.S. Department of Labor; 2011.
5. Vesley D, Lauer J, Hawley R. Decontamination, sterilization, disinfection, and antisepsis. In: Fleming DO, Hunt DL, editors. Biological Safety: Principles and Practices. 3rd ed. Washington (DC): ASM Press; 2000. p. 383–402.
6. Byers KB, Harding AL. Laboratory-associated infections. In: Wooley DP, Byers KB, editors. Biological Safety: Principles and Practices. 5th ed. Washington (DC): ASM Press; 2017. p. 59–92.
7. Greene VW. Microbiological contamination control in hospitals. 1. Perspectives. Hospitals. 1969;43(20):78–88.
8. Boyce JM. The inanimate environment. In: Jarvis WR, editor. Bennett & Brachman's Hospital Infections. 4th ed. Philadelphia (PA): Lippincott Williams & Wilkins; 2014.
9. Lin CS, Fuller J, Mayhall ES. Federal Regulation of Liquid Chemical Germicides by the U.S. Food and Drug Administration. In: Block SS, editor. Disinfection, Sterilization, and Preservation. 5th ed. Philadelphia (PA): Lippincott Williams & Wilkins; 2001. p. 1293–1301.
10. Occupational Safety and Health Administration. Occupational Exposure to Bloodborne Pathogens; Needlestick and Other Sharps Injuries; Final Rule (29 C.F.R. 1910.1030). Fed Regist. 2001;66(12):5318–25.
11. Environmental Protection Agency [Internet]. Washington (DC): Pesticide registration; c2017 [cited 2018 Oct 16]. Selected EPA-registered Disinfectants. Available from: <https://www.epa.gov/pesticide-registration/selected-epa-registered-disinfectants>
12. Centers for Disease Control and Prevention [Internet]. Atlanta (GA): Disinfection and Sterilization; revised 2017 Feb 15 [cited 2018 Oct 16]. Guideline for disinfection and sterilization in healthcare facilities, 2008. Available from: <https://www.cdc.gov/infectioncontrol/pdf/guidelines/disinfection-guidelines.pdf>

13. Favero MS. Sterility assurance: concepts for patient safety. In: Rutala WA, editor. *Disinfection, sterilization and antisepsis: principles and practices in healthcare facilities*. Washington (DC): Association for Professionals in Infection Control and Epidemiology, Inc; 2001. p. 110–9.
14. Favero MS, Bond WW. The use of liquid chemical germicides. In: Morrissey RF, Phillips GB, editors. *Sterilization technology: A practical guide for manufacturers and users of health care products*. New York: Van Nostrand Reinhold; 1993. p. 309–34.
15. Royalty-Hann W. Solutions for biological indicator problems from a quality assurance viewpoint. *Biocontrol Sci*. 2007;12(2):77–81.
16. Lemieux P, Sieber R, Osborne A, Woodard A. Destruction of spores on building decontamination residue in a commercial autoclave. *Appl Environ Microbiol*. 2006;72(12):7687–93.
17. Lauer JL, Battles DR, Vesley D. Decontaminating infectious laboratory waste by autoclaving. *Appl Environ Microbiol*. 1982;44(3):690–4.
18. Rutala WA, Stiegel MM, Sarubbi FA Jr. Decontamination of laboratory microbiological waste by steam sterilization. *Appl Environ Microbiol*. 1982;43(6):1311–6.
19. Tearle P. Decontamination by fumigation. *Commun Dis Public Health*. 2003;6(2):166–8.
20. Girouard DJ, Czarneski MA. Room, suite scale, class III biological safety cabinet, and sensitive equipment decontamination and validation using gaseous chlorine dioxide. *Applied Biosafety*. 2016;21(1):34–44.
21. Kaspari O, Lemmer K, Becker S, Lochau P, Howaldt S, Nattermann H, et al. Decontamination of a BSL3 laboratory by hydrogen peroxide fumigation using three different surrogates for *Bacillus anthracis* spores. *J Appl Microbiol*. 2014;117(4):1095–103.
22. Krishnan J, Fey G, Stansfield C, Landry L, Nguy H, Klassen S, et al. Evaluation of a Dry Fogging System for Laboratory Decontamination. *Applied Biosafety*. 2012;17(3):132–41.
23. Gordon D, Carruthers B-A, Theriault S. Gaseous decontamination methods in high-containment laboratories. *Applied Biosafety*. 2012;17(1):31–9.
24. Czarneski MA, Lorcheim K. A discussion of biological safety cabinet decontamination methods: formaldehyde, chlorine dioxide, and vapor phase hydrogen peroxide. *Applied Biosafety*. 2011;16(1):26–33.
25. Ackland NR, Hinton MR, Denmeade KR. Controlled formaldehyde fumigation system. *Appl Environ Microbiol*. 1980;39(3):480–7.

26. Newsom SW, Walsingham BM. Sterilization of the biological safety cabinet. *J Clin Pathol.* 1974;27(11):921–4.
27. Cheney JE, Collins CH. Formaldehyde disinfection in laboratories: limitations and hazards. *Br J Biomed Sci.* 1995;52(3):195–201. Erratum in: *Br J Biomed Sci.* 1995 Dec;52(4):332.
28. Fox JM, Shuttleworth G, Martin F. Methodology to reduce formaldehyde exposure during laboratory fumigation. *Int J Environ Health Res.* 2013;23(5):400–6.
29. Formaldehyde, 29 C.F.R. Sect. 1910.1048 (2013).
30. National Toxicology Program [Internet]. Research Triangle Park (NC): Department of Health and Human Services; c2016 [cited 2018 Oct 17]. Report on Carcinogens, Fourteenth Edition. Formaldehyde. CAS No. 50-00-0. Available from: <https://ntp.niehs.nih.gov/ntp/roc/content/profiles/formaldehyde.pdf>
31. Luftman HS. Neutralization of formaldehyde gas by ammonium bicarbonate and ammonium carbonate. *Applied Biosafety.* 2005;10(2):101–6.
32. Centers for Disease Control and Prevention [Internet]. Atlanta (GA): The National Institute for Occupational Safety and Health (NIOSH); c2014 [cited 2018 Oct 16]. Formaldehyde. Available from: <https://www.cdc.gov/niosh/idlh/50000.html>
33. Klapes NA, Vesley D. Vapor-phase hydrogen peroxide as a surface decontaminant and sterilant. *Appl Environ Microbiol.* 1990;56(2):503–6.
34. Johnson JW, Arnold JF, Nail SL, Renzi E. Vaporized hydrogen peroxide sterilization of freeze dryers. *J Parenter Sci Technol.* 1992;46(6):215–25.
35. Krause J, McDonnell G, Riedesel H. Biodecontamination of animal rooms and heat-sensitive equipment with vaporized hydrogen peroxide. *Contemp Top Lab Anim Sci.* 2001;40(6):18–21.
36. Graham GS, Rickloff JR. Development of VHP sterilization technology. *J Healthc Mater Manage.* 1992;10(8):54, 56–8.
37. Czarneski MA. Microbial decontamination of a 65-room new pharmaceutical research facility. *Applied Biosafety.* 2009;14(2):81–8.
38. Lorcheim K, Lorcheim P. Mold remediation of a research facility in a hospital. *Applied Biosafety.* 2013;18(4):191–6.
39. Luftman HS, Regits MA, Lorcheim P, Czarneski MA, Boyle T, Aceto H, et al. Chlorine dioxide gas decontamination of large animal hospital intensive and neonatal care units. *Applied Biosafety.* 2006;11(3):144–54.
40. Knapp JE, Battisti DL. Chloride dioxide. In: Block SS, editor. *Disinfection, sterilization, and preservation.* 5th ed. Philadelphia (PA): Lippincott Williams & Wilkins; 2001. p. 215–27.

41. Favero MS, Bond WW. Chemical disinfection of medical and surgical materials. In: Block SS, editor. *Disinfection, sterilization, and preservation*. 5th ed. Philadelphia (PA): Lippincott Williams & Wilkins; 2001. p. 881–917.
42. World Health Organization. WHO Infection Control Guidelines for Transmissible Spongiform Encephalopathies: Report of a WHO consultation Geneva, Switzerland, 23–26 March 1999. Report presented at: WHO Consultation; 1999 Mar 23–26; Geneva, Switzerland.
43. World Health Organization [Internet]. Geneva: Blood Safety and Clinical Technology Department Health Technology and Pharmaceutical Cluster; c2003 [cited 2018 Oct 16]. WHO Guidelines on Transmissible Spongiform Encephalopathies in relation to Biological and Pharmaceutical Products Available from: https://www.who.int/bloodproducts/publications/en/WHO_TSE_2003.pdf?ua=1
44. World Health Organization [Internet]. Geneva: WHO Tables on Tissue Infectivity Distribution in Transmissible Spongiform Encephalopathies; c2010 [cited 2018 Oct 16]. Available from: <https://www.who.int/bloodproducts/tablestissueinfectivity.pdf?ua=1>
45. Department of Defense [Internet]. Washington (DC): Committee for Comprehensive Review of DoD Laboratory Procedures, Processes, and Protocols Associated with Inactivating *Bacillus anthracis* Spores; c2015 [cited 2018 Oct 16]. Review committee report: inadvertent shipment of live *Bacillus anthracis* spores by DoD. Available from: https://dod.defense.gov/Portals/1/features/2015/0615_lab-stats/Review-Committee-Report-Final.pdf
46. Casey ML, Hawley B, Edwards N, Cox-Ganser JM, Cummings KJ. Health problems and disinfectant product exposure among staff at a large multispecialty hospital. *Am J Infect Control*. 2017;45(10):1133–8. Erratum in: 2018;46(5):599.
47. Weber DJ, Rutala WA. Occupational risks associated with the use of selected disinfectants and sterilants. In: Rutala WA, editor. *Disinfection, Sterilization and Antisepsis in Healthcare*. Washington (DC): The Association for Professionals in Infection Control and Epidemiology, Inc.; 1998. p. 211–26.
48. World Health Organization. *Laboratory Biosafety Manual*. 3rd ed. Geneva (Switzerland): World Health Organization; 2004.
49. World Health Organization. *WHO Guidelines on Hand Hygiene in Health Care*. Geneva (Switzerland): WHO Press; 2009.

50. Boyce JM, Pittet D; Healthcare Infection Control Practices Advisory Committee; HICPAC/SHEA/APIC/IDSA Hand Hygiene Task Force. Guideline for hand hygiene in health-care settings. Recommendations of the Healthcare Infection Control Practices Advisory Committee and the HICPAC/SHEA/APIC/IDSA Hand Hygiene Task Force. Society for Healthcare Epidemiology of America/Association for Professionals in Infection Control/Infectious Diseases Society of America. *MMWR Recomm Rep.* 2002;51(RR-16):1–45, quiz CE1–4.

Appendix C—Transportation of Infectious Substances

An infectious substance is a material known to contain or reasonably expected to contain a pathogen. A pathogen is a microorganism (i.e., bacteria, viruses, rickettsiae, parasites, fungi) or other agent (e.g., proteinaceous infectious particle [prion]) that can cause disease in humans or animals. Infectious substances may exist as purified and concentrated cultures but may also be present in a variety of materials or physical states, such as body fluids or tissues or lyophilized materials. Infectious substances and materials that are known or suspected to contain them are regulated as hazardous materials by the United States Department of Transportation (DOT), when transported in commerce in, to, or through the United States and by the International Civil Aviation Organization (ICAO) when transported internationally.

International Harmonization of Shipping and Transport Regulations

The United States works to assure the compatibility of its hazardous materials regulations with those of other bodies such as the United Nations, which issues Recommendations on the Transport of Dangerous Goods. Specialized organizations within the United Nations, such as ICAO, issue detailed instructions based on these recommendations that national governments, including the United States, agree to comply with in full or in part. ICAO references, including the International Air Transport Association (IATA) Dangerous Goods Regulations, establish international standards for the air transport of infectious or toxic materials.^{1,2} The United States prescribes how to comply with these international instructions in 49 CFR Part 171, Subpart C.

Transportation Regulations

International and domestic transport regulations for infectious substances are designed to prevent the release of these materials in transit and to protect the public, workers, property, and the environment from the harmful effects that may occur from exposure to these materials. Protection is achieved through packaging requirements and multiple types of hazard communication. Packages must be designed to withstand rough handling and other forces experienced in transportation, such as vibration, stacking, moisture, and changes in air pressure and temperature. Hazard communication includes shipping papers, labels, markings on the outside of packages, and other information necessary to enable transport workers and emergency response personnel to correctly identify the material and respond efficiently in an emergency situation. Packaging and hazard communication exceptions exist to avoid duplication with other governmental regulations or to appropriately transport infectious substances with fewer risks. In addition, shippers and carriers must be trained on these regulations so that they can properly prepare shipments and recognize and respond to the risks posed by these materials.

Select Agents

Select Agents and Toxins are a subset of biological agents and toxins that the Departments of Health and Human Services (HHS) and Agriculture (USDA) have determined to have the potential to pose a severe threat to public health and safety, to animal or plant health, or to animal or plant products. Persons or organizations who either offer for transportation or transport Select Agents and Toxins in commerce into or throughout the United States must comply with the Select Agent regulations (42 CFR Part 73, 9 CFR Part 121, and 7 CFR Part 331), including requesting prior authorization to transfer or import the agents and toxins. The APHIS/CDC Form 2, Request to Transfer Select Agents and Toxins, is used by persons or organizations to request prior authorization of a transfer of Select Agent(s) or Toxin(s) from the Federal Select Agent Program as required by regulations (7 CFR Part 331, 9 CFR Part 121, and 42 CFR Part 73). Importation and domestic movement permits are no longer required for public health or animal health Select Agent pathogens. More information regarding Select Agents and Toxins is available at <https://www.selectagents.gov>.

Persons who offer for transportation or transport Select Agents in commerce in, to, or through the United States must develop and implement security plans for such transportation. A security plan must include an assessment of the possible transportation security risks for materials covered by the security plan and specific measures to reduce or eliminate the assessed risks. At a minimum, a security plan must include measures to address those risks associated with personnel security, en route security, and unauthorized access.

Regulations

United States Department of Transportation. 49 CFR Parts 171–180, Hazardous Materials Regulations. Applies to the shipment of infectious substances in commercial transportation in, to, or through the United States. Information on these regulations is available at <https://www.phmsa.dot.gov/hazmat>.

United States Postal Service (USPS). 39 CFR Part 20, International Postal Service (International Mail Manual), and Part 111, General Information on Postal Service (Domestic Mail Manual). Regulations on transporting infectious substances through the USPS are codified in Section 601.10.17 of the Domestic Mail Manual and Section 135 of the International Mail Manual. A copy of the Domestic and International Mail Manuals may be obtained from the USPS Postal Explorer website at <https://pe.usps.com/DMM300/Index>.

Occupational Health and Safety Administration (OSHA). 29 CFR Section 1910.1030, Occupational Exposure to Bloodborne Pathogens. These regulations provide minimal packaging and labeling for blood and body fluid when transported within a laboratory or outside of it. Information may be obtained from your local OSHA office or at <https://www.osha.gov>.

Technical Instructions for the Safe Transport of Dangerous Goods by Air (Technical Instructions). International Civil Aviation Organization (ICAO). These regulations apply to the shipment of infectious substances by air and are recognized in the United States and by most countries worldwide. A copy of these regulations may be purchased from the ICAO Document Sales Unit on the ICAO website at <https://store.icao.int/> or by email to sales@icao.int.

Dangerous Goods Regulations. International Air Transport Association (IATA). Global standards are detailed in this widely recognized publication on requirements for the transport of biological and chemical hazards. They are issued by IATA, an airline association, based on the ICAO Technical Instructions, and followed by most airline carriers. A copy of these regulations may be purchased from IATA at <https://www.iata.org/publications/dgr/Pages/index.aspx> or by email to custserv@iata.org.

Importation and Transfers

Regulations governing the transfer of biological agents are designed to ensure that possession of these agents is in the best interest of the public and the nation. These regulations require documentation of personnel and facilities, justification of need, and pre-approval of the transfer by a federal authority. The following regulations apply to this category:

Biological Agent or Vectors of Human Disease Import Permit. 42 CFR Section 71.54. Unless the material meets one of the regulatory exclusions, this regulation requires a permit from the CDC Import Permit Program to import infectious biological agents, infectious substances, and vectors of human disease into the United States. More information is available at the CDC Import Permit Program website at <https://www.cdc.gov/cpr/ipp/index.htm>.

Transfer of any Select Agents or Toxins requires the intended recipient to be registered with the Select Agent Program and submit an APHIS/CDC Form 2 as required to obtain approval to import the Select Agent or Toxin prior to each importation event (see 42 CFR Part 73, 9 CFR Part 12, and/or 7 CFR Part 330).

Importation of Pathogenic Agents of Livestock, Poultry and Other Animal Diseases and Other Materials Derived from Livestock, Poultry or Other Animals. 9 CFR Part 122. Organisms and Vectors. The USDA, APHIS, Veterinary Services (VS) requires that a permit be issued prior to the importation or domestic transfer (interstate movement) of pathogenic disease agents of livestock, poultry, or other animals. Information may be obtained at 301-851-3300 or from the USDA website at <https://www.aphis.usda.gov/aphis/ourfocus/animalhealth>. Completed permit applications may be submitted electronically at https://www.aphis.usda.gov/permits/learn_epermits.shtml.

Importation of Plant Pests. 7 CFR Part 330. Federal Plant Pest Regulations; General; Plant Pests; Soil, Stone, and Quarry Products; Garbage. This regulation requires a permit to move into or through the United States or by interstate any plant pest or a regulated product, article, or means of conveyance in accordance with this part. Information can be obtained by calling 301-851-2357 or at the USDA APHIS website at <https://www.aphis.usda.gov/aphis/ourfocus/planthealth/import-information>.

Transfer of USDA Plant Pests

The movement of Plant Pests is regulated under two distinct and separate regulations: (1) 7 CFR Part 331—Possession, Use, and Transfer of Select Agents and Toxins; and (2) 7 CFR Part 330—Federal Plant Pest Regulations; General; Plant Pests; Soil; Stone and Quarry Products; Garbage. The regulation found at 7 CFR Part 331 requires an approved Transfer Form (APHIS/CDC Form 2) prior to importation, interstate, or intrastate movement of a Select Agent Plant Pest. In addition, under 7 CFR Part 330, the movement of a Plant Pest also requires a PPQ Form 526 permit for movement in, to, or through the United States, or interstate any plant pest or a regulated product, article, or means of conveyance in accordance with this part. Information can be obtained by calling 301-851-2357 or at the Select Agent Program website at <https://www.selectagents.gov>.

Export of Human, Animal, and Plant Pathogens and Related Materials; Department of Commerce (DoC); 15 CFR Parts 730–799. This regulation requires that exporters of a wide variety of etiologic agents of human, plant, and animal diseases, including genetic material, and products that might be used for culture of large amounts of agents, will require an export license. Information may be obtained by calling the DoC Bureau of Industry and Security (BIS) at 202-482-4811 or at the DoC BIS website at <https://www.bis.doc.gov>. Additional web resources include:

1. <https://www.bis.doc.gov/index.php/regulations/export-administration-regulations-ear>
2. <https://classic.ntis.gov/products/export-regs/>

DOT Packaging of Infectious Substances

General DOT Packaging Requirements for Transport of Infectious Substances by Aircraft

DOT-compliant packaging is required by domestic and international air carriers for transport of infectious substances. DOT packaging regulations are also the basis for infectious substance packaging designed for motor vehicle, railcar, and vessel transport. The following is a summary of each packaging type and related transportation requirements.

Category A Infectious Substance (UN 2814 and UN 2900): Figure 1. A Category A material is an infectious substance that is transported in a form that is capable of causing permanent disability or life-threatening or fatal disease to otherwise healthy humans or animals when exposure to it occurs. An exposure occurs when an infectious substance is released outside of its protective packaging, resulting in physical contact with humans or animals. Category A infectious substances are assigned to identification number “UN 2814” for substances that cause disease in humans or in both humans and animals, or “UN 2900” for substances that cause disease in animals only.

Figure 1 shows an example of the UN standard triple packaging system for materials known or suspected of being a Category A infectious substance as outlined in the Packaging Instruction of the IATA Dangerous Goods Regulations.³ The package consists of a watertight primary receptacle or receptacles; a watertight secondary packaging; and a rigid outer packaging of adequate strength for its capacity, mass, and intended use. Note that for liquid materials, the secondary packaging must contain absorbent material in sufficient quantities to absorb the entire contents of all primary receptacles. A list of contents must be located on or near the secondary packaging. Each surface of the external dimension of the packaging must be 100 mm (3.9 inches) or more. The completed package must pass specific performance tests, including a drop test and a water-spray test, and must be capable of withstanding, without leakage, an internal pressure producing a pressure differential of not less than 95 kPa (0.95 bar, 14 psi). The completed package must also be capable of withstanding, without leakage, temperatures in the range of -40°C to +55°C (-40°F to 131°F). The completed package must be marked “UN 2814, Infectious substance, affecting humans,” or “UN 2900, Infectious substance, affecting animals,” and labeled with a Division 6.2 (infectious substance) label. In addition, the package must be accompanied by appropriate shipping documentation, including a shipping paper and emergency response information.

Figure 1. A Category A UN Standard Triple Packaging

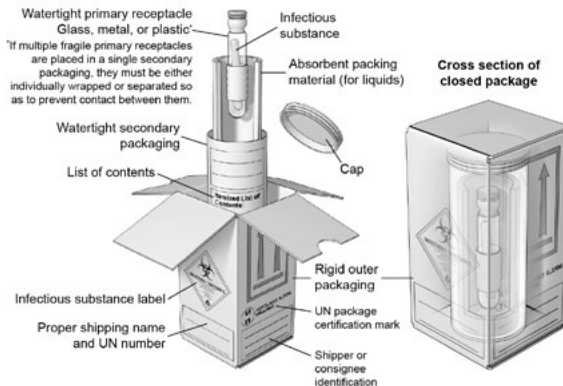

Category B Biological specimen (UN 3373): Figure 2. A Category B infectious substance is one that does not meet the criteria for inclusion in Category A. A Category B infectious substance does not cause permanent disability or life-threatening or fatal disease in otherwise healthy humans or animals when exposure to it occurs. The proper shipping name for a Category B infectious substance is “UN3373, Biological substance, Category B.”

Figure 2 shows an example of the triple packaging system for materials known or suspected of containing a Category B infectious substance. A Category B infectious substance must be placed in a packaging consisting of a leak-proof primary receptacle, leak-proof secondary packaging, and rigid outer packaging. At least one surface of the outer packaging must have a minimum dimension of 100 mm by 100 mm (3.9 inches). The packaging must be of good quality and strong enough to withstand the shocks and loadings normally encountered during transportation. For liquid materials, the secondary packaging must contain absorbent material in sufficient quantities to absorb the entire contents of all primary receptacles. For aircraft, the primary or secondary packaging must be capable of withstanding, without leakage, an internal pressure producing a pressure differential of 95 kPa (0.95 bar, 14 psi). The package must be constructed and closed to prevent any loss of contents that might be caused under normal transportation conditions by vibration or changes in temperature, humidity, or pressure. The completed package must be capable of passing a 1.2 meter (3.9 feet) drop test. The package must be marked with a diamond-shaped marking containing the identification number “UN 3373” and labeled with the proper shipping name “Biological substance, Category B.” In addition, the name, address, and telephone number of a person knowledgeable about the material must be provided on a written document, such as an air waybill, or on the package itself.

Figure 2. A Category B Non-specification Triple Packaging

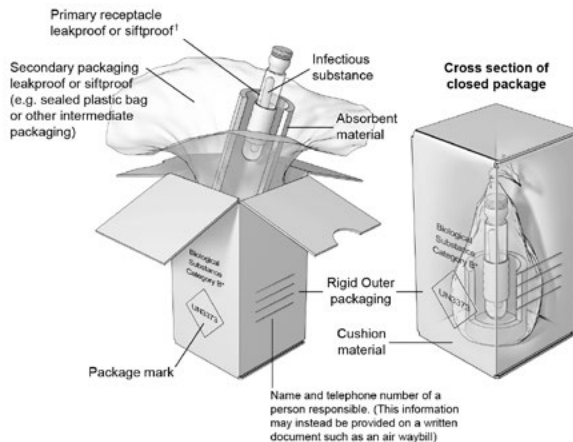

Intrafacility Specimen and Sample Transfers

Any movement of a pathogen between parts of an institution, which would require transport in a motor vehicle, on public roads, would require compliance with the requirements given previously in this Appendix. However, movement of a pathogen on private roads within the confines of a contiguous facility boundary (e.g., a campus) where public access is restricted is not commercial transportation and, therefore, is not subject to these requirements. If movement of a pathogen is on or crosses a public road, it also is not subject to these requirements if access to the public road is restricted by signals, lights, gates, or similar controls.^{4–8}

It is also common to need to move samples or cultures between laboratories, between floors in a building, or by walking samples between buildings. When a sample needs to be moved, care should be taken to minimize the transport through public and office areas. Avoid passenger elevators when possible, using stairs and freight elevators instead. It is recommended that the sample(s) be placed in a sealable bag or container to provide primary leak-proof containment. Place absorbent in the bag or container to absorb any spilled material in the event of a loss. Place the sealed bag or container in a durable, rigid outer container for transport. Disinfect the exterior of the outer container as appropriate depending on the risk posed by the material to be transported. PPE to be worn during transit is based on the institution's risk assessment.

Transfer of specific, high-risk pathogens, even within an organization, may need approval from USDA, CDC, or the Federal Select Agent Program.

References

1. International Civil Aviation Organization [Internet]. Montreal (Quebec): Safety; c2017–2018 [cited 2018 Dec 4]. Technical Instructions for the Safe Transport of Dangerous Goods by Air (Doc 9284). Available from: <https://www.icao.int/safety/dangerousgoods/pages/technical-instructions.aspx>
2. 3.6.2 Division 6.2—Infectious Substances. In: International Air Transport Association. IATA Dangerous Goods Regulations. 60th ed. Montreal: IATA; 2019. p. 177–81.
3. Packaging Instruction 650. In: International Air Transport Association. IATA Dangerous Goods Regulations. 60th ed. Montreal: IATA; 2019. p. 557–9.
4. United States Department of Transportation [Internet]. Washington (DC): Pipeline and Hazardous Materials Safety Administration; c2017 [cited 2018 Dec 4]. Interpretation Response #16-0134. Available from: <https://www.phmsa.dot.gov/regulations/title49/interp/16-0134>

5. United States Department of Transportation [Internet]. Washington (DC): Pipeline and Hazardous Materials Safety Administration; c2009 [cited 2018 Dec 4]. Interpretation Response #08-0244. Available from: <https://www.phmsa.dot.gov/regulations/title49/interp/08-0244>
6. United States Department of Transportation [Internet]. Washington (DC): Pipeline and Hazardous Materials Safety Administration; c2006 [cited 2018 Dec 4]. Interpretation Response #06-0113. Available from: <https://www.phmsa.dot.gov/regulations/title49/interp/06-0113>
7. United States Department of Transportation [Internet]. Washington (DC): Pipeline and Hazardous Materials Safety Administration; c2006 [cited 2018 Dec 4]. Interpretation Response #06-0088. Available from: <https://www.phmsa.dot.gov/regulations/title49/interp/06-0088>
8. United States Department of Transportation [Internet]. Washington (DC): Pipeline and Hazardous Materials Safety Administration; c2004 [cited 2018 Dec 4]. Interpretation Response #04-0116. Available from: <https://www.phmsa.dot.gov/regulations/title49/interp/04-0116>

Appendix D—Biosafety and Biocontainment for Pathogens Affecting Agricultural Animals and Animals that are Loose-Housed or in Open Penning

Questions regarding this information should be directed to USDA/Agricultural Research Service (ARS) Office of National Programs, Animal Production & Protection, which is responsible for the content of this appendix.

Introduction

Appendix D focuses primarily on *in vitro* and *in vivo* research and diagnostic activities involving pathogens that primarily affect agricultural animals and other animal species that cannot be housed in primary containment isolators or an equivalent means of primary containment following challenge. Basic biocontainment principles used for human pathogen studies provide the foundation for biosafety and biocontainment practices that reduce the risk of inadvertent release of agriculture-specific agents into the environment or native animal populations; see [Sections IV](#) and [V](#) for additional information. However, enhancements may be necessary to address specific conditions and requirements essential for research involving agriculture-specific pathogens. This is particularly important when agricultural animals and wildlife used in research must be loose-housed or maintained in open penning where the room or facility serves as the primary biocontainment barrier.

The host range of these veterinary pathogens may be limited to animals, although some may also have zoonotic potential and could pose a risk to both animals and humans. The wide spectrum of animal species routinely used for agricultural research includes those found in commercial agricultural production facilities; commercial aquaculture; wildlife; and traditional laboratory animals. The potential for accidental biohazard release due to research activities could lead to significant regional and national economic consequences from animal morbidity, animal mortality, and international trade restrictions that may be imposed. These additional economic and environmental risks must be considered when developing biosafety and biocontainment risk assessments for working with pathogens that infect agricultural animals. The implementation of biocontainment guidelines and risk mitigation strategies for working with agriculturally important pathogens should also be driven by protocols that clearly distinguish between these pathogens and pathogens that are solely a real or potential threat to human health. Additional emphasis is placed upon biocontainment measures in assessing the risk of work with agricultural pathogens to reduce or eliminate the risk of agent release into the environment.

Due to their size and disposition, agricultural animals can cause injuries and/or physical trauma to workers outside those expected with smaller laboratory animals, and these incidents fall outside the scope generally considered in biosafety oversight. All staff who work with large animals should at a minimum receive species-specific training in animal behavior, effective handling practices, and other physical safety precautions. Whenever possible, experienced staff should be assigned to train and supervise new employees until skill and competency have been verified.

This appendix includes a section titled *Potential Enhancements for Work with Pathogens Affecting Agricultural Animals*. This section describes enhancements that exceed standard practices, procedures, containment equipment, and facility design features common to traditional Biosafety Level 2 (BSL-2), Animal Biosafety Level 2 (ABSL-2), BSL-3, ABSL-3, BSL-4, and ABSL-4 laboratories and facilities. These enhancements should be considered for work with pathogens that affect agricultural animals. The USDA's Animal and Plant Health Inspection Service-Veterinary Services (USDA APHIS VS), other regulatory entities, or local policies and procedures may have additional requirements for working with agricultural pathogens in an *in vitro* laboratory or with animals maintained inside primary containment isolators.

This appendix also includes sections on ABSL-2-Agriculture (ABSL-2Ag), ABSL-3Ag, and ABSL-4Ag for work with animals infected with high consequence or otherwise regulated livestock pathogens (as defined in 9 CFR Section 122.2) that are loose-housed or in open penning. These sections describe special practices, procedures, containment equipment, and/or facility design features needed for pathogen/agent studies requiring agricultural or wildlife species that cannot be housed in a primary containment isolator. When animals are loose-housed or in open penning, the room or facility serves as the primary barrier for pathogen containment, so construction and operational design features are critical biosafety components. For instance, biological safety cabinets (BSCs) cannot be used for whole animal manipulations, and the volume of waste generated often exceeds the capacity of typical laboratory-scale programs for the disposal of animal waste, bedding, and carcasses.

Developing safe work practices, facility design requirements, and engineering features needed to maintain optimal containment levels must also include risk assessments for specific procedures that will be performed. These assessments must include risks associated with agents to be studied, the selection of animal models, and proposed work activities. Some agent characteristics that should be considered include host range, infectious dose, mode of transmission, treatment and immunization availability, environmental stability, and whether the agent is indigenous or exotic to the location where it will be used. Factors that should be considered during animal model selection include proposed species; breed or

strain (if applicable); age, size, and gender; animal source or vendor; inherent susceptibility to infection; the effect stress may have on shedding of the agent; ease of handling vs. animal behavior and responses to stress; and health and immunization status of the animals. Elements of study design and proposed work activities that should be evaluated include agent quantity, concentration, and culture requirements (i.e., agar vs. broth); aerosol-generating procedures (e.g., high-pressure pen wash-downs during normal animal care); ability to use primary containment equipment for manipulations and housing; exposure or challenge methods; and decontamination methods. Identifying necessary personnel training and experience in animal handling and general biosafety and biocontainment practices are also critical to the health and safety of both workers and animals.

Although this appendix focuses on planned research involving known animal pathogens, the information and concepts can also be applied to animal diagnostic laboratories where work involves “unknown” or suspect diagnostic specimens. These diagnostic laboratories receive a wide range of samples that often contain pathogens, both specific to animals and zoonotic. The virulence of isolated agents can vary greatly and can cause diseases in animals and humans that range in significance from low to high consequence. Carefully analyzing clinical histories and other background information that accompanies diagnostic samples is critical for determining an appropriate mitigation strategy to help to control disease spread and minimize its impact on human and agricultural health. Information in this appendix should be augmented with the recommendations of the Biosafety Blue Ribbon Panel convened by the U.S. Centers for Disease Control and Prevention (CDC)¹ for developing and implementing safety practices and procedures for animal diagnostic laboratories, as well as taking into account standard veterinary medical and husbandry best practices that protect veterinary medical workers in the field, such as on-farm management practices that prevent disease introduction and cross-contamination of farms.

This appendix provides guidance for performing robust risk assessments and determining optimal biosafety practices and containment features that should be implemented to address those risks. It is not intended as a regulatory document. USDA APHIS regulates all cultures or collections of organisms and their derivatives (e.g., DNA, RNA) that may introduce or disseminate contagious or infectious diseases of livestock and poultry, as well as plants. Institutions that receive and work with these controlled materials must be approved for the work and issued a permit before work begins, as well as adhering to the specific conditions and requirements in the permit, other relevant regulatory requirements, and/or applicable local rules, policies, and guidelines. The results of site-specific risk assessments may inform the specific implementation of biocontainment procedures necessary to meet regulatory requirements, but they do not supersede them. In addition to the conduct of a robust local risk assessment, institutions should consult with appropriate regulatory agencies before planning

new construction or renovating existing facilities to ensure the completed project is fully functional for all planned uses.

Tables 1–6 and Table Keys 1–3 provide information and guidance regarding the potential hosts, routes of infection, environmental stability, and recommended containment levels for *in vitro* research (BSL), *in vivo* research with small animals (ABSL), and *in vivo* research with large animals (Ag requirements) for a number of different agents and toxins. These tables can assist in the development of a risk assessment and must be modified by a specific analysis of the work to be performed and the specific agent used. Note that the agents listed are representative of the genus and containment information provided and should not be considered the definitive list of agents.

Potential Enhancements for BSL-2 and ABSL-2 Facilities for Conducting Work with Pathogens Affecting Agricultural Animals

USDA APHIS VS, other regulatory authorities, or local policies may require additional enhancements that exceed standard BSL-2 and ABSL-2 requirements before approving the possession or study of certain controlled organisms and their derivatives (e.g., DNA, RNA) that affect agricultural animals. These agents may be zoonotic or primary animal pathogens; pose low to moderate economic risk to the agricultural sector; and are generally classified as Risk Group 1 (RG-1) or RG-2 human pathogens.

Specific enhancements that may be prescribed by regulatory authorities during the permitting process are mandatory. Institutions may choose to supplement the required features with additional enhancements based on a site-specific risk assessment described in the introduction of this appendix and appropriate for the proposed laboratory and vivarium procedures. The following is a partial list of actions that may be appropriate:

1. Personnel may be required to use additional personal protective equipment (PPE).
2. Agent and/or infected animal manipulations are performed exclusively inside a BSC (if possible due to size limitations) or other primary containment device.
3. Contaminated effluent is collected for disinfection and validated for inactivation before discharge into facility drainage system or drains to a dedicated Drain Waste Vent system feeding an effluent decontamination system prior to sanitary sewer.
4. Administrative controls and policies are developed to limit contact between containment staff and susceptible animals outside the BSL-2 or ABSL-2 enhanced containment space (i.e., off-premises personally recognizable quarantine policy that is based on agent and species factors).

Potential Enhancements for BSL-3 and ABSL-3 Facilities for Conducting Work with Pathogens Affecting Agricultural Animals

Baseline laboratory techniques, safety procedures, containment equipment, and facility design features are commensurate with those found in standard BSL-3 and/or ABSL-3 facilities. In addition, supplemental administrative and engineering controls that mitigate potential risks these agents pose to surrounding animal populations and the environment may be necessary. The agents considered here include pathogens of agricultural and wildlife species that pose moderate- to high-risk to agricultural production and may also be zoonotic pathogens. Specific control measures are strategically implemented based on a rigorous risk assessment process.

USDA APHIS VS, other regulatory authorities, or local policies may specify additional enhancements that exceed standard BSL-3 and ABSL-3 requirements before approving the possession or study of certain controlled organisms and their derivatives (e.g., DNA, RNA) that affect agricultural animals.

Additional restrictions apply to certain agents that are not indigenous to the United States. Approval for possession and experimental use of these pathogens is contingent on minimum physical containment and security requirements. In some cases, a permit is required to import or otherwise acquire live organisms.

Potential enhancements, based on a risk assessment, to increase the safety and biocontainment of BSL-3 and ABSL-3 containment facilities designed for *in vitro* procedures and/or *in vivo* work with animals housed and manipulated within primary containment are listed below:

1. Potential Facility Enhancements
 - a. Personnel enter through a series of barriers that provide complete separation of potentially contaminated animals, materials, and equipment in BSL-3 or ABSL-3 containment space from other areas of the building. This can be accomplished through a combination of procedures and basic facility design.
 - b. Mechanically interlocked entry/exit vestibule doors or an equivalent mechanism or process (e.g., work practices) are used to prevent opening both doors simultaneously.
 - c. Emergency exit doors are configured to allow safe egress but cannot be used to gain unauthorized access to the facility. It is recommended that emergency exits have vestibules to store emergency decontamination materials.

- d. HEPA filtration of exhaust air. If necessary:
 - i. Exhaust HEPA filters outside of the BSL-3 or ABSL-3 containment barrier should be located as close to the containment space as possible to minimize the length of potentially contaminated air ducts.
 - ii. Construction of exhaust HEPA filter housings must allow independent certification testing of each filter in place after installation and either in-place decontamination or features that permit the filter to be bagged-out for removal and decontamination or disposal.²
 - iii. The installation of redundant parallel exhaust HEPA filter units, which accommodate filter changes without disrupting laboratory activities, should be considered.
 - iv. Pre-filters should be installed at the room level before the exhaust HEPA filter and changed frequently to improve effectiveness and extend HEPA filter life.
- e. Engineering features that protect supply air against airflow reversals, if necessary. These could include:
 - i. A dedicated fresh air supply, which has not been previously circulated, is preferred; appropriate enhancements should especially be considered if the air supply for the containment space is drawn from contiguous non-containment space rather than a dedicated outside supply.
 - ii. HEPA filtration of air supply and/or installation of fast-acting bioseal dampers.
- f. Installation of an effluent decontamination system (EDS). If needed:
 - i. Construction should allow for cycle validation with biological indicators or another equivalent efficacy verification method.
 - ii. The EDS should be installed in a containable space that is designed to prevent contamination of adjacent space in the event of a leak and be able to be adequately sealed to facilitate space decontamination, if necessary. A site-specific risk assessment should be performed to identify design features needed in the containable space, including airlocks, exit showers, special PPE, containment basins or diking of EDS tanks, or exhaust air filtration.

- iii. Plumbing should pass through piping tunnels that allow visual line inspections; alternatively, double-walled piping with annular leak detection should be installed in areas that do not allow visual inspection and cannot be readily accessed for maintenance and repair.
 - iv. Floor drains may be capped and sealed if an EDS is not present.
2. Potential Practice Enhancements
- a. Personnel may be required to use additional PPE based upon site-specific risk assessment.
 - b. Administrative controls and policies that limit contact between containment staff and susceptible animals outside the BSL-3 or ABSL-3 enhanced containment space (i.e., personally recognizant quarantine policy).

BSL-4 and ABSL-4 Facilities that Work with Pathogens Affecting Agricultural Animals

Standard BSL-4 and ABSL-4 practices, procedures, containment equipment, and facility design features ([Sections IV](#) and [V](#) of BMBL) are generally adequate for *in vitro* procedures involving Risk Group 4 agents in a BSL-4 laboratory or *in vivo* work involving animals housed inside primary containment isolators in an ABSL-4 facility.

Potential Enhancements for Animal Biosafety Level 2-Agriculture (ABSL-2Ag) Facilities for Conducting Work with Animals that are Loose-Housed or in Open Penning

ABSL-2Ag is recommended for *in vivo* work involving agents requiring ABSL-2 containment/practices and that includes large livestock and wildlife species that cannot be housed in primary containment isolators. The animals are maintained in open penning or loosely housed within a pen/enclosure that may be a single room, an area within a larger building (e.g., a suite of rooms), or an entire building. Agents may be primary animal pathogens or zoonotic, are classified as RG-1 or RG-2, and pose low to moderate economic risks to the agricultural sector. An example could be a potentially serious agricultural pathogen that is endemic in the location where the laboratory is situated.

ABSL-2Ag includes the standard practices, procedures, containment equipment, and facility design features required for ABSL-2. The perimeter of the primary containment zone is defined by the physical room and an outer containment zone by the physical facility, making its construction and design features critically important for risk mitigation and pathogen containment. Appropriate supplemental enhancements should be selected after a robust risk assessment and should

address specific conditions or requirements stipulated by USDA APHIS VS (9 CFR Section 122.2), other relevant regulatory entities, or local policies and procedures.

Potential enhancements to increase the safety of ABSL-2Ag containment facilities designed for *in vivo* work with large livestock and wildlife species are listed below:

1. Potential Facility Enhancements
 - a. Entrance into the facility should be through a series of barriers and/or procedures that provide a distinct separation between containment and non-containment areas. Provisions should be included for removing, disinfecting, and/or disposing of contaminated PPE, footwear, uniforms, and/or equipment before exiting the ABSL-2Ag containment area.
 - b. A boot wash should be installed at the entry/exit of the animal room or ABSL-2Ag containment barrier. The disinfectant solution should be changed as needed to maintain efficacy.
 - c. A site-specific risk assessment should be performed to determine if personal showers are needed for personnel exiting the ABSL-2Ag containment space—at either the room level, the facility level, or both.
 - d. Penning, gating, and/or animal restraint systems must be appropriate for the species being housed and must be selected/selected as part of a comprehensive risk assessment process performed in consultation with the veterinary staff. Critical factors that should be considered include animal size, proposed procedures, and safe handling strategies. The equipment should be free of pinch points and sharp edges that could injure animals or individuals working in the ABSL-2Ag space and should be sealed or coated with a finish that is resistant to disinfectants and water pressures used for routine cleaning. Rooms equipped with modular or changeable units may be advantageous since they can be used to house a wider range of species.
 - e. A site-specific risk assessment should be performed to determine the need for a ventilation system that is capable of maintaining directional airflow from low hazard areas to higher hazard areas, which exhausts directly to the outside. Ventilation system options can include natural ventilation or forced air systems that may include a dedicated, ducted supply and exhaust system that discharges to the outside.

- i. Air handling systems serving areas where large animals are housed or manipulated should be designed to maintain environmental conditions that are consistent with relevant animal welfare requirements in addition to the needs of minimizing emissions (to include particulates).
 - ii. If an exhaust system is provided, the exhaust air cannot be recirculated to non-animal room/barn areas and may only be recirculated to other equivalent containment animal rooms within the animal facility/barn (i.e., not to non-animal areas or non-containment animal rooms). If exhaust air is recirculated, the possibility of cross-contamination in the event of system failure must be addressed in locally developed, site-specific incident response plans.
 - iii. The site-specific risk assessment should determine the need to provide particulate filtration for supply and/or exhaust air systems that service ABSL-2Ag areas to prevent cross-contamination between animals on study and other animals housed in or near the facility, including wildlife.
- f. Equipment and supplies must be available for cold storage and decontamination of large animal carcasses, and adequate decontamination of solid and/or liquid waste.
- i. Examples of typical decontamination systems used in ABSL-2Ag facilities include autoclaves, tissue digesters, incinerators, and renderers.
 - ii. Alternate or redundant decontamination systems and procedures should be available for when the primary system requires maintenance or repairs.
 - iii. Composting or other nonconventional disposal methods may be considered if their use is supported by a risk assessment that specifically considers the location, long-term stability, and proximity of the disposal site relative to other susceptible animals maintained outside the ABSL-2Ag facility.
 - iv. The effectiveness of all decontamination methods in use must be validated.
 - v. A local risk assessment should be conducted to determine if effluent in animal room drainage systems can be safely discharged to the sanitary sewer or if it must be collected for disinfection before disposal.

- g. Cleaning supplies and equipment must be available to decontaminate penning, gates, transport crates, and other large devices in direct contact with animals. Surfaces and design features of these items should permit thorough cleaning and sanitation. Some articles may need to be disassembled for complete decontamination.
- h. Floors, ceilings, and walls in animal rooms must be constructed of monolithic materials that are durable and resistant to damage from animal impact and pressurized sprays, chemical disinfectants, hot water, or steam that is used for sanitation. Electrical wiring (e.g., outlets) and equipment (e.g., light fixtures) installed in wet or otherwise hazardous locations must be properly sealed and grounded. Animal welfare issues (e.g., footing) must be considered in material selection, application, and use.

2. Potential Practice Enhancements

- a. A site-specific risk assessment should be conducted to identify local practices, equipment, and facility design features that are needed to protect workers, animals, and the environment.
 - i. The use of supplemental PPE (e.g., face shields, shin guards, respirators) and/or facility equipment with advanced safety features (e.g., quick release latches, self-closing gates) should be considered to protect workers and animals from hazards encountered while working with agricultural animals in close quarters and to protect animals from accidental entrapment or escape.
 - ii. Special exit procedures and/or facility features (e.g., anterooms for PPE or clothing changes, boot-washing stations, shower facilities) may be needed for workers to exit the containment area safely.
- b. Administrative controls and policies should be established that limit contact between containment staff and susceptible animals outside the ABSL-2Ag containment space (i.e., personally recognizable quarantine policy).
- c. It is recommended that administrative controls and policies be established for a minimum of two workers to be present in the containment area at all times (i.e., a “buddy system”) or other means of monitoring worker safety in containment. Operational protocols should also require all staff to be trained on appropriate response procedures for time-sensitive emergencies involving workers pinned or otherwise entangled by equipment or animals.

Animal Biosafety Level 3-Agriculture (ABSL-3Ag) Facilities required for activities involving the use of hazardous biological agents designated as High-Consequence Foreign Animal Diseases and Pests by USDA APHIS in animals that are loose-housed or in open penning

ABSL-3Ag containment incorporates standard practices, procedures, containment equipment, and facility design features common to ABSL-3 and ABSL-2Ag facilities (see preceding sections) but also incorporates many of the facility features usually reserved for ABSL-4 facilities as enhancements. This level of containment is required for animals that must be housed in open cages or pens and that have been infected with specific transboundary livestock or wildlife pathogens defined by USDA APHIS VS. The agents involved may either be animal pathogens that pose significant economic risk to the agricultural sector or agents with zoonotic potential that are classified as RG-1, RG-2, or RG-3 pathogens. Many of the agents listed in Tables 1–6 that require ABSL-3Ag are veterinary pathogens and typically do not pose a severe or high-likelihood risk to human health. Specific enhancements for research involving these agents can be found in the USDA Agricultural Research Services Facilities Design Standards 242.1M-ARS^{3–8} available at <https://www.afm.ars.usda.gov/>; however, USDA APHIS VS Select Agent Regulations (9 CFR Part 121) will specify required facility enhancements that exceed standard ABSL-3 requirements for research involving agricultural pathogens that pose significant economic risk to local, regional, or national agricultural sectors.

Because large animals and wildlife species involved in research and diagnostic activities cannot be housed in primary containment isolators, the room perimeter serves as the primary containment barrier. The containment zone may consist of a single room, a suite of rooms within a larger facility, or may occupy an entire building. The area of containment functions as a “box within a box” and is completely isolated from non-containment areas. Access is strictly controlled and is limited to personnel who have been properly trained and cleared. Special physical security features often associated with ABSL-4 facilities may be incorporated to safeguard against unauthorized entries.

A site-specific risk assessment should be completed that documents the various ABSL-3 and ABSL-2Ag enhancements (see preceding sections) considered for implementation. Supplemental enhancements should be based on the results of this risk assessment and on any specific conditions or requirements stipulated by USDA APHIS VS, other relevant regulatory entities, or local policies and procedures.

At minimum, ABSL-3Ag containment facilities must meet requirements associated with ABSL-3 and ABSL-2Ag containment; and incorporate some enhancements usually found in ABSL-4 facilities. Potential enhancements to increase the safety of ABSL-3Ag containment facilities designed for *in vivo* work with large animals

are listed below. USDA APHIS VS, other relevant regulatory entities, or local policies and procedures will determine which enhancements are required based on the specific details of the proposed work.

1. Potential Facility Enhancements

- a. Access to containment areas should be restricted to authorized personnel. All entry and exit points should be secured with locks or equivalent electronic access systems and protected by alarms that will alert authorities of unauthorized movement into or out of the facility.
- b. The entrance to the ABSL-3Ag containment facility should have a double door vestibule that separates containment areas from non-containment areas; the doors should be mechanically interlocked to prevent simultaneous opening.
 - i. When two doors are interlocked, at least one of the doors must meet air pressure resistant (APR) specifications, preferably the door that opens into non-containment space (i.e., the door from the facility shower to non-containment space).
 - ii. Personnel must be trained to close the APR doors completely without damaging them when entering or exiting.
 - iii. A site-specific risk assessment should be performed to assess the benefits of installing a second APR door between the animal room exit and the door used to exit the biocontainment facility to maintain correct air pressure differentials. Unless specifically identified as a permitting or regulatory requirement, a room-level APR door may not be needed if the containment area is maintained under negative pressure such that when the facility-level APR door is opened, air is inward-directional and contains any pathogens that may have escaped the animal room.
 - iv. APR doors may be equipped with pneumatic or mechanical compression seals. A risk assessment must be conducted to determine if pneumatic doors should be equipped with redundant seals (i.e., two-layer or separate seals that are not linked but rather are filled independently to ensure a defect in one does not cause the second to fail) to ensure the system's integrity. Mechanical compression seals should be checked and adjusted at regular intervals to ensure full contact when the seal is engaged.

- v. Pneumatic lines that inflate the gaskets on APR doors should be equipped with HEPA filters and check valves, as air from the containment space can enter the lines if a hole occurs in the gasket.
 - vi. Integral features of all APR doors (e.g., hinges, latches, knobs, locking mechanisms, viewing panels) must be sealed and verified airtight through pressure decay testing. Airtight verification is defined in Appendix 9B of the USDA ARS Facilities Design Standards 242.1M-ARS.8 Pressure decay testing must be completed (1) before occupying the facility, (2) following any structural modifications to the facility, and (3) at regular intervals determined through a site-specific risk assessment while the facility is in use.
 - vii. APR doors may require reinforcements or structural enhancements to ensure the integrity of the door seal if they are at risk of being physically damaged by large animals. A factory acceptance test that simulates anticipated impact load is recommended to ensure the door unit will meet minimum load requirements.
 - viii. The facility may include separate dedicated receiving bays or vestibules equipped with interlocked APR doors that are separate from the main entrance and/or equivalent transport systems (e.g., pass-through dunk tanks, gaseous fumigation chambers, autoclaves). These separate facilities can be used as dedicated storage areas (e.g., feed and bedding) or to move equipment and supplies into and out of the ABSL-3Ag containment space. A local risk assessment may identify acceptable operational alternatives that provide an equivalent level of containment, such as combining inward-directional airflow with a single APR door between the contained corridor and the vestibule, rather than two interlocked doors.
- c. Decontamination of personnel exiting the containment zone should involve two separate transitions to ensure maximum environmental protection: the first transition involves exiting the animal room and entering the change room, and the second transition involves exiting the change room and then the containment zone or facility. While various design and procedural options are available for incorporating these transition zones, selection should be based on the results of a local risk assessment and relevant regulatory

and permit requirements. From a design perspective, ABSL-3Ag facilities must have a personal shower at the containment-non-containment boundary even if alternate exit strategies are implemented that do not always require a second shower by personnel. Some strategies include:

- i. A comprehensive solution where two separate personal shower facilities are utilized. Personnel shower two times: (1) before entering the change room from the animal room (i.e., a room-level shower), and (2) after exiting the animal room shower and before leaving the facility (i.e., a facility-level shower).
 - ii. Personnel are required to have a complete clothing change before entering each animal room or suite (i.e., experimental unit) to ensure clothing worn inside the animal room is separate and distinct from that worn in spaces outside the animal room (e.g., hallways, laboratories). This facilitates a transition between containment zones (i.e., ABSL-3Ag to a containment corridor that accesses other containment spaces [BSL-3 or other ABSL-3Ag animal rooms]) and should be paired with a facility-level shower to ensure a contained to non-containment space personal decontamination step.
 - iii. Decontamination of outer PPE within the animal containment room or suite, followed by PPE removal as the worker steps into a transition area located between containment and lower containment or non-containment zones. The process must be carefully documented to ensure the procedures can be performed easily and consistently by personnel working in these areas and must be paired with an animal room level exit shower to ensure adequate personal decontamination and environmental protection step.
 - iv. Provisions for disinfecting and changing contaminated boots before moving between or exiting containment units (i.e., animal rooms) should be employed.
- d. Penning, gating, and/or animal restraint systems must be appropriate for the species housed, and these systems should be selected/ designed as part of a comprehensive risk assessment performed in consultation with the veterinary staff. Critical factors to consider include animal size, proposed procedures, and safe handling strategies. The equipment should be free of pinch points and sharp edges

that could injure animals or individuals working in the ABSL-3Ag space and sealed or coated with a finish that is resistant to disinfectants and water pressures used for routine cleaning. Rooms equipped with modular or changeable units may be advantageous since they can be used to house a wider range of species.

- e. Appropriate equipment and supplies should be available inside the ABSL-3Ag facility to decontaminate large animal waste, carcasses, and other contaminated refuse and articles that need to be removed from the containment area. This equipment should include design features that ensure the same level of containment as the primary barrier.
 - i. Examples of typical decontamination systems used in ABSL-3Ag facilities include autoclaves, tissue digesters, incinerators, renderers, gaseous decontamination chambers, liquid disinfectant dunk tanks, and similar equipment. Autoclaves, tissue digesters, renderers, and incinerators should be designed or programmed to prevent opening of the outer door until the decontamination cycle is completed and verified to have met program parameters.
 - ii. The installation of equipment designed with pass-through features that permit contaminated articles to be loaded into an autoclave or sterilizer inside the containment zone and decontaminated before removal on the non-containment side. This equipment should be installed with mechanical elements located or accessible outside the ABSL-3Ag facility to facilitate routine maintenance and repairs.
 - iii. A site-specific risk assessment should be performed to determine the need for filtration or decontamination of the condensate and/or exhaust from decontamination equipment (e.g., autoclaves).
- f. Liquid effluents from ABSL-3Ag containment areas must be collected and decontaminated before disposal into a sanitary sewer. Collection and decontamination methods should be selected after a site-specific risk assessment.
 - i. Installation of a central liquid effluent waste collection and decontamination system is the preferred method.
 - ii. Heat decontamination systems must be designed so that the contaminated effluent can be held at specified temperatures, pressures, and times to ensure complete inactivation of all

hazardous materials. Systems should operate at a range of temperatures and holding times to economically and efficiently process a wide range of effluents.

- iii. At minimum, effluents from laboratory sinks, BSCs, and floor drains should be directed into the waste collection system for decontamination before discharge. A site-specific risk assessment should be performed to (1) determine if effluent from autoclave chambers, shower rooms, and toilets should be collected and decontaminated, and (2) identify the optimal decontamination method that is required (i.e., validated chemical treatment system or heated liquid waste decontamination system).
 - iv. Facilities should be designed with basement access or piping tunnels that allow the facility waste plumbing systems to be inspected. Double containment piping systems with annular leak detection capability should be used for plumbing that is buried, concealed, or located outside the containment facility.
- g. Waste handling procedures must adhere to the results of a site-specific risk assessment and applicable regulations and local policies and procedures.
- i. Decontamination systems and procedures must be validated using biological indicators, culture of treated waste, or another equivalent process to ensure the selected cycle and operating parameters are appropriate for the agents as well as the types and volumes of waste generated.
 - ii. Operating parameters should be validated for each load type that is treated, and periodically verified using an appropriate method.
 - iii. In some cases, a two-step waste treatment process may be indicated. For example, waste can first be autoclaved for removal from the containment facility and then destroyed through incineration (i.e., locally at the facility or through a commercial service). Regulations pertaining to the transport of potentially infectious waste must be considered in this process.
 - iv. Disposal methods such as composting or spreading manure on fields are not allowed.
- h. ABSL-3Ag facilities are required to have dedicated, single-pass ventilation systems that create and maintain an appropriate inward-directional pressure gradient.

- i. The air supply and exhaust system must be independent or isolatable, and it must provide graded pressure differentials such that inward directional airflow is maintained in containment spaces relative to adjacent non-containment areas in the event of a breach (e.g., opening doors). Pressure differentials must be designed such that air moves continuously from low hazard areas to higher hazard areas in the event of a breach.
- ii. A visual indicator that displays real-time pressure differentials should be available outside the containment facility to confirm that personnel can enter safely.
- iii. Audible or visual alarms are needed that can be heard and/or seen both inside and outside of the containment space to alert staff when pressure differentials are outside the pre-set range. The alarm system should be compatible with worker safety and animal welfare (i.e., audible without being so loud that animals are startled or stressed, or just visual). Intercom systems should limit the type and number of overhead announcements that can be disruptive and contribute to excessive noise levels.
- iv. Ventilation system performance must be validated (1) before the facility becomes operational, (2) at least annually while the facility is operational, and (3) following any significant modifications to the ventilation system. Guidelines for standards to be used in risk assessments and the development of site-specific validation protocols can be found in the following:
 1. USDA ARS Facilities Design Standards 242.1M-ARS3–8
 2. ANSI/ASSE Z9.14 Testing and Performance Verification Methodologies for Ventilation Systems for Biological Safety Level 3 (BSL-3) and Animal Biological Safety Level 3 (ABSL-3) Facilities²
- i. HVAC system pressure differentials should be designed after a site-specific risk assessment to incorporate engineering features that protect against sustained reversal of directional airflow in the event of a breach of containment (e.g., opening doors).
 - i. Air supply and exhaust systems should be interlocked to prevent sustained reversal of directional airflow during HVAC failures or emergencies that can lead to positive pressurization of containment spaces.

- ii. Supply air must pass through ductwork with either a HEPA filter and/or a fast-acting bioseal (i.e., bubble-tight) damper that fails in the closed position to prevent the reverse flow of contaminated air through supply ducts into other containment zones or non-containment areas outside the facility.
 - iii. In the absence of a supply HEPA filter(s), a robust preventative maintenance program that includes an annual validation process must be implemented to ensure the fast-acting bioseal damper operates as designed to prevent airflow reversal.
 - iv. Bioseal dampers must consistently fail in the closed position and continue to function properly during power failures (e.g., electrically held open, mechanically and automatically closed in a power failure). Gaskets should be constructed of materials that will seal properly, regardless of scheduled applications of lubricants and/or sealants. The seal must be capable of withstanding the air pressures applied as fans spin down in a power failure.
- j. The exhaust air from ABSL-3Ag facilities should pass through ductwork with two HEPA filters installed in series prior to being exhausted to the outside.
- i. HEPA filters should be located outside of the containment zone to facilitate routine maintenance and validation procedures. They should also be located as close to the ABSL-3Ag facility as possible to minimize the overall length of potentially contaminated ductwork outside the containment zone.
 - ii. Pressure decay testing must be used to confirm that HEPA filter frames, housing, and the ductwork between the ABSL-3Ag facility and the HEPA filter are airtight. This testing is described in the USDA ARS Facilities Design Standards 242.1M-ARS.3–8
 - iii. Methods for effectively decontaminating sections of potentially contaminated ductwork that extends outside the ABSL-3Ag facility should be identified and validated.
 - iv. HEPA filter housings must be fabricated to allow the filters to be scan-tested after installation and decontaminated in place before removal. Parallel HEPA filter units that allow filter changes and scan testing without disrupting facility operation should be considered for maximum flexibility and efficiency. Configuration and operation of parallel units should be carefully evaluated to ensure continuous operation.

- v. Redundant exhaust fans must be installed to ensure containment parameters are maintained continuously during equipment maintenance, and redundant supply fans are highly recommended. Precautions should be taken if fast-acting dampers are used in closed rooms instead of redundant supply fans because extreme negative pressures can develop that can injure personnel and animals or cause structural damage.
- vi. Pre-filters (at least 80–90% efficiency) should be installed in air supply and exhaust ductwork to extend the functional life of HEPA filters. Pre-filters should be installed inside the biocontainment room or facility to facilitate frequent changes that can be completed without decontaminating the exhaust system. Used pre-filters should be regarded as contaminated and disinfected or decontaminated by a validated method before they are removed from the ABSL-3Ag facility for disposal.
- vii. Air handling systems must be able to regulate the temperature and humidity in areas where animals are housed or manipulated, and the exhaust air cannot be recirculated to supply non-animal areas.
- k. Plumbing traps must be kept filled with liquid disinfectant or capped, and the atmospheric vents associated with these traps must have HEPA filters or their equivalent installed. Whenever possible, deep-seal plumbing traps should be used to prevent potential cross-contamination due to loss of seal, back pressure, or trap siphonage.
- l. HEPA filters must be installed on return lines of pneumatic systems (e.g., plumbing vents, pneumatic lines for inflatable door seals, vacuum systems).
 - i. In general, central vacuum systems are discouraged. When a vacuum source is needed, a HEPA filter should be installed near the service cock or point of use.
 - ii. Installation should allow in-place filter decontamination and/or replacement without exposing the local environment to potential contamination.
- m. Construction materials used in an ABSL-3Ag facility should be appropriate for the intended end use. Walls must be constructed slab-to-slab and must be contiguous with the floor and ceiling.

- i. All penetrations in the floors, walls, and ceilings must be sealed and verified to be airtight to prevent cross-contamination and to allow gaseous or vapor phase fumigation within the containment facility without affecting adjacent non-containment space (see specifications in the USDA ARS Facilities Design Standards 242.1M-ARS).³⁻⁸ This includes openings around ductwork; plumbing fixtures; doorframes; door hardware and gaskets; electrical boxes; and vents.
 - ii. When required, exterior windows and vision panels must be sealed and constructed of breakage-resistant materials sufficient to withstand animal kicks or bites.
 - iii. The room envelope must meet the minimum criteria for a primary containment barrier that is equivalent to performance standards established for secondary barriers in ABSL-3 spaces. Each ABSL-3Ag primary containment unit (i.e., room, suite) must be verified as airtight.
- n. Necropsy rooms must be equipped and large enough to safely accommodate work on research animals housed in the containment unit. Equipment (i.e., ceiling hoists, wall-mounted drag systems, mobile tilt tables) and strategies to assist with the humane transport of moribund animals and the carcasses of dead animals that are too large for facility staff to move manually should be incorporated into facility design and operations.
 - o. If BSCs are installed, they must be selected, located, installed, operated, and maintained according to the manufacturer's instructions and standards found in NSF/ANSI 49-2018 and [Appendix A](#). Due to the high rate of air exchange and room pressure fluctuations that occur with APR door operation in ABSL-3Ag facilities, all ventilated equipment should undergo extensive functional testing during installation and at an increased frequency while in operation to ensure proper placement and operation.
2. Potential Practice Enhancements
- a. Access to containment areas should be controlled, monitored, and limited to personnel who are adequately trained, cleared, and authorized to work in this area. A trained escort must be provided for other individuals who enter the facility, such as inexperienced workers, visitors, and service providers.
 - b. Personnel should follow a redundant, two-step decontamination

process when exiting the ABSL-3Ag facility to prevent accidental contamination of non-containment space. Workers may be required to shower or wear extra PPE that can be surface-decontaminated upon exiting a primary containment room, followed by an additional shower before exiting the containment facility. However, a wide range of options are available to meet this requirement, and a site-specific risk assessment that incorporates relevant regulatory and permit requirements should be performed to determine appropriate decontamination protocols.

- c. Administrative controls and policies should limit contact between containment staff and susceptible animals outside the ABSL-3Ag containment space (i.e., personally recognizable quarantine policy based on site-specific risk assessment and regulatory requirements).
- d. Administrative controls and policies should recommend a minimum of two workers to be present in the containment area at all times (i.e., a “buddy system”) or other means of monitoring worker safety in containment. All staff working in biocontainment areas should be trained on appropriate response procedures for time-sensitive emergencies involving workers pinned or entrapped by equipment or animals.

Animal Biosafety Level 4-Agriculture (ABSL-4Ag) Facilities for Conducting Work with Animals that are Loose-Housed or in Open Penning

ABSL-4Ag containment incorporates standard practices, procedures, containment equipment, and facility design features common to ABSL-4 and ABSL-3Ag facilities (see previous sections). This level of containment is required for animals infected with zoonotic pathogens that would ordinarily require (1) facilities and procedures commensurate with ABSL-4 containment as determined by relevant regulatory authorities, or (2) a comprehensive local risk assessment, which also assesses the cross-contamination risk, for animals that cannot be housed in primary containment isolators (e.g., open caging units inside flexible film isolators with inward-directional airflow that is separate from the facility’s HVAC system). Personnel working in the ABSL-4Ag containment zone must wear positive-pressure suits.

Agents studied in ABSL-4Ag containment can pose a significant economic risk to the agricultural sector and are also zoonotic pathogens consistent with RG-3 or RG-4 classification, for which effective treatments and/or preventative measures are not available for humans. Animals used in this research are housed loosely

or in open penning, so the room perimeter serves as the primary containment barrier. The containment zone may consist of a single room, a suite of rooms within a larger facility, or an entire building. The area of containment functions as a “box within a box” and is completely isolated from non-containment areas. Access is strictly controlled and limited to personnel who have been properly trained and cleared. Special physical security features that are required for standard ABSL-4 facilities must be incorporated to safeguard against unauthorized entries.

A site-specific risk assessment should be completed that documents the various ABSL-4 and ABSL-3Ag enhancements that were considered. Supplemental enhancements should be based on the results of this risk assessment and should be implemented with specific conditions or requirements stipulated by USDA APHIS VS, other relevant regulatory entities, or local policies and procedures.

At minimum, ABSL-4Ag containment facilities must meet requirements associated with ABSL-4 and ABSL-3Ag containment. Potential enhancements to increase the safety of ABSL-4Ag containment facilities designed for *in vitro* procedures and/or *in vivo* work with animals are listed below:

1. Potential Facility Enhancements

- a. APR doors must be equipped with pneumatic or mechanical compression seals. A risk assessment should be conducted to determine if pneumatic doors need redundant seals (i.e., two-layer or separate seals that are not linked and are filled independently to ensure a defect in one does not cause the second to fail) to ensure the system’s integrity. Mechanical compression seals must be checked and adjusted at regular intervals to ensure full contact when the seal is engaged.
 - i. Pneumatic lines that inflate the gaskets on APR doors must be equipped with HEPA filters and check valves when there is any possibility that air from the containment space is entering the lines.
 - ii. Doors may be self-closing and may require reinforcements or structural enhancements to ensure the integrity of door seals if they are at risk from physical damage by large animals. A factory acceptance test that simulates anticipated impact load is recommended to ensure door units will meet minimum load requirements.
 - iii. Pressure decay testing must be used to ensure integral features of all doors (e.g., hinges, latches, knobs, locking mechanisms, viewing panels) are verified to be sealed and airtight.

- b. The ABSL-4Ag room includes a separate dedicated vestibule equipped with interlocked APR doors that are separate from the main entrance and/or equivalent transport systems (e.g., pass-through dunk tanks, gaseous fumigation chambers, autoclaves) that can be used as dedicated storage areas (e.g., feed and bedding) or to move equipment and supplies into and out of the ABSL-4Ag containment space. Construction of the vestibule and APR doors must be compatible with chemicals used to decontaminate or fumigate contaminated equipment, waste, and supplies before removal from the containment facility.
- c. A chemical decontamination shower will generally be required before exiting the primary ABSL-4Ag containment zone (large animal room). However, a simple physical decontamination step/shower of the positive-pressure suit (e.g., water wash down shower) may be sufficient if moving between rooms of similarly treated animals (i.e., infected with the same experimental agent).
 - i. To prevent cross-contamination of different experimental groups, full PPE decontamination is generally required before movement into a new containment zone (e.g., separate BSL-4, ABSL-4, or other ABSL-4Ag areas) from an ABSL-4 Ag room/zone. However, if you are employing a low- to high-risk movement strategy (e.g., working with uninfected controls before experimentally infected animals), a chemical decontamination shower may not be required to move between specific rooms. A project-specific risk assessment must be conducted to address these issues, but a full chemical decontamination shower is required before exiting the maximum containment facility.
 - ii. Location and operational parameters of a decontamination vestibule or chemical shower at the containment barrier should be determined through a site-specific risk assessment that includes factors such as containment requirements, research needs, and experimental workflow.
 - iii. Installation of boot washes and boot storage is recommended adjacent to animal room exits and the decontamination shower.
 - iv. A risk assessment to determine selection of encapsulating suits with or without integral boots will need to occur. In some cases, it may be advantageous to utilize suits that do not have integral boots to allow boot changes between rooms, where personnel

will use a boot wash and maintain a set of boots in each ABSL-4Ag animal room.

- d. Ventilation system performance must be validated (1) before the facility becomes operational, (2) at least annually while the facility is operational, and (3) following any significant modifications to the ventilation system. Local risk assessment processes and the development of site-specific validation protocols should be conducted using standards and guidelines found in the following:
 - i. USDA ARS Facilities Design Standards 242.1M-ARS3–8
 - ii. ANSI/ASSE Z9.14 Testing and Performance-Verification Methodologies for Ventilation Systems for Biological Safety Level 3 (BSL-3) and Animal Biological Safety Level 3 (ABSL-3) Facilities²
- e. Ceiling-mounted self-coiling air lines or tension tethers to suspend air lines away from animals and equipment must be used to prevent entanglement and damage to the lines. The system design should accommodate the need for personnel to safely enter and exit pens with animals, but work practices should minimize such contact as much as possible with the use of chutes, isolation gates, and/or free pens to facilitate movement of animals away from personnel unless contact is absolutely required.

2. Potential Practice Enhancements

- a. Personnel must wear a positive-pressure ventilated protective suit with a safe breathing air source.
 - i. Pressurized suits should not have integral foot covers or boots; separate work boots are recommended.
 - ii. The durability of pressurized suits should be evaluated to confirm they are suitable for anticipated work conditions involving agricultural animals that are housed loosely or in open penning.
- b. Personnel working in pressurized suits should be trained in the strategic use of penning, gating, and animal restraint equipment to minimize potential contact with animals, animal waste, and sharp surfaces.
- c. Administrative controls and policies should recommend a minimum of two workers to be present in the containment area at all times (i.e., a “buddy system”) or other means of monitoring worker safety

in containment. All staff should be trained on appropriate response procedures for time-sensitive emergencies involving workers who are pinned or otherwise trapped by equipment or animals.

Table 1. Bacteria

Genus	Agent(s)	Hosts ¹	Routes ²	Stability ³	<i>In vitro</i> Cont.	<i>In vivo</i> Cont.	<i>In vivo</i> Ag Cont.	Other Reqs
<i>Actinobacillus</i> spp.	<i>A. pleuropneumoniae</i>	3	3, 4, 5	2	2	2	2Ag–3Ag	N/A
<i>Aeromonas</i> spp.	<i>A. hydrophila</i> , <i>A. salmonicida</i>	5	3, 8	2	2	2	2Ag	N/A
<i>Anaplasma</i> spp.	<i>A. centrale</i> , <i>A. marginale</i> , <i>A. phagocytophilum</i>	1a	2, 4	2	2	2	2Ag	N/A
<i>Arcobacter</i> spp.	<i>A. butzleri</i> , <i>A. cryaerophilus</i> , <i>A. skirrowii</i>	1, 2, 3, 10b	1, 8	2	2	2	2Ag	N/A
<i>Bacillus</i> spp.	<i>B. anthracis</i> , <i>B. cereus</i>	1–10	2, 3, 8	1–3	2–3	2–3	2Ag–3Ag	Y
<i>Bartonella</i> spp.	<i>B. henselae</i>	7b, 9	2, 4	2	2	2	2Ag	N/A
<i>Bibersteinia</i> spp.	<i>B. trehalosi</i>	1	9	2	2	2	2Ag	N/A
<i>Borrelia</i> spp.	<i>B. burgdorferi</i>	2, 4, 7, 10b	2	2	2	2	2Ag	N/A
<i>Brucella</i> spp.	<i>B. abortus</i> , <i>B. canis</i> , <i>B. melitensis</i> , <i>B. ovis</i> , <i>B. suis</i>	1, 2, 3, 6, 7a, 10b	1, 3, 4, 5, 7, 8	2	2–3	2–3	2Ag–3Ag	Y
<i>Burkholderia</i> spp.	<i>B. mallei</i> (<i>Pseudomonas mallei</i>), <i>B. pseudomallei</i>	1, 2, 3, 7, 10b	1, 3, 4, 5	2	3	3	2Ag–3Ag	Y
<i>Campylobacter</i> spp.	<i>C. coli</i> , <i>C. fetus fetus</i> , <i>C. fetus venerealis</i> , <i>C. jejuni</i>	1, 3, 4a	1, 8	1	2	2	2Ag	N/A
<i>Chlamydia</i> spp.	<i>C. caviae</i> , <i>C. felis</i> , <i>C. muridarum</i> , <i>C. pecorum</i> , <i>C. pneumoniae</i> , <i>C. psittaci</i> , <i>C. suis</i> , <i>C. trachomatis</i>	1, 2, 3, 4, 5, 6, 7, 8, 10	3, 4, 5	2	2–3	2–3	2Ag–3Ag	N/A
<i>Chlamydomphilus</i> spp.	<i>C. abortus</i>	1c	3, 4, 5	2	2	2	2Ag–3Ag	N/A
<i>Clostridium</i> spp.	<i>C. botulinum</i> , <i>C. difficile</i> , <i>C. perfringens</i> , Types A, B, C, and D	1–10	1, 8	2–3	2–3	2–3	2Ag–3Ag	Y
<i>Coxiella</i> spp.	<i>C. burnetii</i>	1	3, 4, 5	3	3	3	2Ag–3Ag	Y
<i>Cronobacter</i> spp.	<i>C. sakazakii</i> (<i>Enterobacter sakazakii</i>)	10b	4	2	2	2	2Ag	N/A
<i>Ehrlichia</i> spp.	<i>E. canis</i> , <i>E. chaffeensis</i> , <i>E. ewingii</i> , <i>E. ondiri</i> , <i>E. ruminantium</i>	1, 6a, 7, 10b	2	1–2	2	2	2Ag	N/A
Environmental Mastitis	<i>E. coli</i> , <i>Streptococcus uberis</i> , <i>Klebsiella</i> , <i>Proteus</i> , <i>Pseudomonas</i> , <i>Serratia</i> spp.	1a	9	2	2	2	2Ag	N/A
<i>Erysipelothrix</i> spp.	<i>E. rhusiopathiae</i>	1c, 3, 4, 5, 6d, 7c, 10b	4, 8	3	2	2	3Ag	N/A

Continued on next page ►

Genus	Agent(s)	Hosts ¹	Routes ²	Stability ³	<i>In vitro</i> Cont.	<i>In vivo</i> Cont.	<i>In vivo</i> Ag Cont.	Other Reqs
<i>Escherichia</i> spp.	<i>E. coli</i>	1, 2, 3, 4, 6, 7, 8, 10	1, 4, 8	2	2	2	2Ag–3Ag	N/A
<i>Flavobacteria</i> spp.	<i>F. branchiophilum</i> , <i>F. columnare</i> , <i>F. psychrophilum</i>	5	3, 7	1	2	2	2Ag	N/A
<i>Francisella</i> spp.	<i>F. tularensis</i>	1, 2, 3, 4, 5, 6, 7, 10	2, 3, 4	2	3	3–4	2Ag–3Ag	Y
<i>Histophilus</i> spp.	<i>H. somni</i> (<i>Haemophilus somnus</i>)	1a	9	2	2	2	2Ag	N/A
<i>Leptospira</i> spp.	<i>L. bratislava</i> , <i>L. canicola</i> , <i>L. grippityphosa</i> , <i>L. hardjo</i> , <i>L. icterohaemorrhagiae</i> , <i>L. interrogans</i> , <i>L. pomona</i>	1, 2, 3, 6, 7, 8, 10	9	2	2	2	2Ag	N/A
<i>Listeria</i> spp.	<i>L. monocytogenes</i>	1, 3, 4, 6, 7, 8, 10	1	2	2	2	2Ag	N/A
<i>Mannheimia</i> spp.	<i>M. haemolytica</i>	1a	9	2	2	2	2Ag	N/A
<i>Melissococcus</i> spp.	<i>M. plutonius</i>	9	2, 8	2	2	2	2Ag	N/A
<i>Moraxella</i> spp.	<i>M. bovis</i>	1a	2, 3, 4	2	2	2	2Ag	N/A
<i>Mycobacterium</i> spp.	<i>M. avium</i> subsp <i>paratuberculosis</i> , <i>M. bovis</i> , <i>M. chelonae</i> , <i>M. fortuitum</i> , <i>M. marinum</i> , <i>M. neoaurum</i> , <i>M. scrofulaceum</i> , <i>M. simiae</i>	1, 5, 6a, 10b	1, 3, 4, 5	2	2–3	2–3	2Ag–3Ag	Y
<i>Mycoplasma</i> spp.	<i>M. agalactiae</i> , <i>M. bovis</i> , <i>M. capricolum</i> <i>capripneumoniae</i> (F 38), <i>M. gallisepticum</i> , <i>M. hyopneumoniae</i> , <i>M. mycoides capri</i> (PG 3), <i>M. mycoides</i> (large colony type), <i>M. mycoides mycoides</i> (small colony type), <i>M. synoviae</i>	1, 2, 4	1, 3, 4, 5, 7, 9	2	2	2–3	2Ag–3Ag	Y
<i>Paenibacillus</i> sp.	<i>P. larvae larvae</i>	9	4, 7	2	2	2	2Ag	N/A
<i>Pasteurella</i> spp.	<i>P. multocida</i>	1a	9	2	2	2	2Ag	N/A
<i>Pleisomonas</i> spp.	<i>P. shigelloides</i>	1, 3, 4, 5, 6, 7, 10	1, 8	2	2	2	2Ag	N/A
<i>Pseudomonas</i> spp.	<i>P. aeruginosa</i>	10b	4	2	2	2–3	2Ag	N/A
<i>Renibacterium</i> spp.	<i>R. salmoninarum</i>	5a	4, 7	2	2	2	2Ag	N/A
<i>Rhodococcus</i> spp.	<i>R. equi</i>	1, 2, 3, 7b, 10b	2	2	2	2	2Ag	N/A
<i>Rickettsia</i> spp.	<i>R. felis</i> , <i>R. prowazekii</i> , <i>R. rickettsii</i> , <i>R. typhi</i> , <i>Orientia tsutsugamushi</i>	6, 7a, 8, 9, 10b	2, 3, 4	3	2	2–3	2Ag–3Ag	Y
<i>Salmonella</i> spp.	<i>S. enterica</i> (including serovars Abortusovis, Choleraesuis, Dublin, Enteritidis, Gallinarum, and Typhimurium) <i>S. bongori</i>	1a, 3, 4, 5, 6c	3, 4, 5, 7, 8	2	2	2	2Ag	N/A
<i>Shigella</i> spp.	<i>S. boydii</i> , <i>S. dysenteriae</i> , <i>S. flexneri</i> , <i>S. sonnei</i>	1a, 4a, 10b	1, 8	2	2	2	2Ag	N/A

Continued on next page ►

Genus	Agent(s)	Hosts ¹	Routes ²	Stability ³	<i>In vitro</i> Cont.	<i>In vivo</i> Cont.	<i>In vivo</i> Ag Cont.	Other Regs
<i>Spirillum</i> spp.	<i>S. minus</i>	8, 10b	4, 8	2	2	2	2Ag	N/A
<i>Staphylococcus</i> spp.	<i>S. aureus</i> (mastitis)	1, 2, 3, 6, 7, 8, 10	8	2	2	2–3	2Ag	N/A
<i>Streptobacillus</i> spp.	<i>S. moniliformis</i>	8, 10b	4, 8	2	2	2	2Ag	N/A
<i>Streptococcus</i> spp.	<i>S. canis</i> , <i>S. equi equi</i> , <i>S. equi zooepidemicus</i> , <i>S. iniae</i> , <i>S. pyogenes</i> , <i>S. suis</i>	1–10	1, 3, 4, 5, 8	2	2	2	2Ag	Y
<i>Taylorella</i> spp.	<i>T. equigenitalis</i>	2	4, 5	2	2	2	2Ag	Y
<i>Vibrio</i> spp.	<i>V. cholerae</i> , <i>V. parahaemolyticus</i> , <i>V. vulnificus</i>	5	8	2	2	2	2Ag	N/A
<i>Xenohaliotis</i> spp.	<i>X. californiensis</i>	5d	1	2	2	2	2Ag	Y
<i>Yersinia</i> spp.	<i>Y. enterocolitica</i> , <i>Y. pestis</i> , <i>Y. pseudotuberculosis</i> , <i>Y. ruckeri</i>	1, 2, 3, 5, 7, 8, 10b	3, 4, 8	1–2	2–3	3–4	2Ag–3Ag	Y

Table 2. Fungi and Molds

Genus	Agent(s)	Hosts ¹	Routes ²	Stability ³	<i>In vitro</i> Cont.	<i>In vivo</i> Cont.	<i>In vivo</i> Ag Cont.	Other Regs
<i>Aphanomyces</i> spp.	<i>A. astaci</i> , <i>A. invadans</i>	5	1, 3, 4	2	2	2	2Ag–3Ag	Y
<i>Batrachochytrium</i> spp.	<i>B. dendrobatidis</i>	6e	3, 4	2	2	2	2Ag	N/A
<i>Coccidioides</i> spp.	<i>C. immitis</i> , <i>C. posadasii</i>	1a, 2, 3, 7, 10b	3, 5	2	3	3	2Ag–3Ag	N/A
<i>Cryptococcus</i> spp.	<i>C. neoformans</i>	1, 2, 4, 6, 7, 10b	3	2	2	2	2Ag	N/A
<i>Epidermophyton</i> spp.	<i>E. floccosum</i>	1, 2, 3, 7, 10b	4	2	2	2	2Ag	N/A
<i>Histoplasma</i> spp.	<i>H. capsulatum farciminosum</i>	2	2, 3, 4	2	3	3	2Ag–3Ag	N/A
<i>Microsporium</i> spp.	<i>M. canis</i> , <i>M. gypseum</i> , <i>M. nanum</i>	1, 2, 3, 7	4	2	2	2	2Ag	N/A
<i>Nosema</i> spp.	<i>N. apis</i> , <i>N. ceranae</i>	9	3, 4	3	2	2	3Ag	N/A
<i>Pseudogymnoascus</i> spp.	<i>P. destructans</i>	6g	4	2	2	2	2Ag	N/A
<i>Saprolegnia</i> spp.	<i>S. parasitica</i>	5	3	2	2	2	2Ag	N/A
<i>Sporothrix</i> spp.	<i>S. schenckii</i>	1, 2, 3, 4, 5, 6, 7, 8, 10b	1, 4	2	2	2	2Ag	N/A
<i>Trichophyton</i> spp.	<i>T. equinum</i> , <i>T. mentagrophytes</i> , <i>T. verrucosum</i>	1, 2, 3, 7	4	2	2	2	2Ag	N/A

Table 3. Nematodes, Trematodes, Cestodes, Protozoa, and Ectoparasites

Genus	Agent(s)	Hosts ¹	Routes ²	Stability ³	<i>In vitro</i> Cont.	<i>In vivo</i> Cont.	<i>In vivo</i> Ag Cont.	Other Regs
<i>Acarapis</i> spp.	<i>A. woodi</i>	9	4	2	2	2	2Ag	N/A
<i>Aethina</i> spp.	<i>A. tumida</i>	9	4	2	2	2	2Ag	N/A
<i>Alaria</i> spp.	<i>A. americana</i>	6d, 7	6	1	2	2	2Ag	N/A
<i>Amblyomma</i> spp.	<i>A. americanum</i> , <i>A. maculatum</i>	1, 2, 3, 4, 6, 7, 8, 10	4	2	2	2	2Ag	N/A
<i>Amphimerus</i> spp.	<i>A. pseudofelineus</i>	5, 6b, 7, 10b	6, 8	2	2	2	2Ag	N/A
<i>Ancylostoma</i> spp.	<i>A. braziliense</i> , <i>A. caninum</i> , <i>A. duodenale</i>	7, 10b	4	2	2	2	2Ag	N/A
<i>Anisakis</i> spp.	<i>A. pegreffii</i> , <i>A. simplex</i>	5	8	2	2	2	2Ag	N/A
<i>Babesia</i> spp.	<i>B. bovis</i> , <i>B. bigemina</i> , <i>B. divergens</i> , <i>B. major</i> , <i>B. ovata</i> , <i>B. occultans</i> , <i>B. jakimovi</i>	1, 2, 6a, 10b	2, 6	2	2	2	2Ag	Y
<i>Baylisascaris</i> spp.	<i>B. columnaris</i> , <i>B. melis</i> , <i>B. procyonis</i>	1, 2, 3, 4, 6, 7, 10	1, 6	2	2	2	2Ag	N/A
<i>Besnoitia</i> spp.	<i>B. besnoiti</i>	1a	6	2	2	2	2Ag	N/A
<i>Bonamia</i> spp.	<i>B. ostreae</i> , <i>B. exitiosa</i>	5d	4	2	2	2	2Ag	Y
<i>Bunostomum</i> spp.	<i>B. phlebotomum</i>	1	1, 6	2	2	2	2Ag	N/A
<i>Ceratonova</i> spp.	<i>C. shasta</i>	5a	3	2	2	2	2Ag	N/A
<i>Chrysomya</i> spp.	<i>C. bezziana</i>	1, 2, 3, 4, 6, 7, 8, 10	4, 6	2	2	2	2Ag	Y
<i>Cochliomyia</i> spp.	<i>C. hominivorax</i>	1, 2, 3, 4, 6, 7, 8, 10	4, 6	2	2	2	2Ag	Y
<i>Cryptosporidium</i> spp.	<i>C. parvum</i>	1, 2, 3, 10b	1, 4	2	2	2	2Ag	N/A
<i>Dicrocoelium</i> spp.	<i>D. dendriticum</i>	1, 2, 6, 7, 10b	6	1	2	2	2Ag	N/A
<i>Diphyllobothrium</i> spp.	<i>D. dendriticum</i> , <i>D. latum</i>	10b	6, 8	2	2	2	2Ag	N/A
<i>Echinococcus</i> spp.	<i>E. granulosa</i> , <i>E. multilocularis</i> , <i>E. oligarthrus</i> , <i>E. shiquicus</i> , <i>E. vogeli</i>	1, 3, 7a, 10b	1	2	2	2	2Ag	N/A
<i>Echinostoma</i> spp.	<i>E. cinetorchis</i> , <i>E. hortense</i> , <i>E. liei</i> , <i>E. revolutum</i>	4, 5, 6, 7, 10b	1	2	2	2	2Ag	N/A
<i>Eimeria</i> spp.	<i>E. acervulina</i> , <i>E. brunetti</i> , <i>E. maxima</i> , <i>E. meleagridis</i> , <i>E. necatrix</i> , <i>E. tenella</i>	1, 2, 3, 4, 6d, 7	1	2	2	2	2Ag	N/A
<i>Entamoeba</i> spp.	<i>E. histolytica</i>	10	1, 5	3	2	2	2Ag	N/A
<i>Fasciola</i> spp.	<i>F. hepatica</i>	1, 6a	6	1	2	2	2Ag	N/A
<i>Fascioloides</i> spp.	<i>F. magna</i>	1, 6a	6	1	2	2	2Ag	N/A
<i>Giardia</i> spp.	<i>G. duodenalis</i> , <i>G. intestinalis</i> , <i>G. lambia</i>	1, 3, 6, 8, 7, 10	1, 5	2	2	2	2Ag	N/A
<i>Gyrodactylus</i> spp.	<i>G. salaris</i>	5a	4	2	2	2	2Ag	N/A

Continued on next page ►

Genus	Agent(s)	Hosts ¹	Routes ²	Stability ³	<i>In vitro</i> Cont.	<i>In vivo</i> Cont.	<i>In vivo</i> Ag Cont.	Other Regs
<i>Histomonas</i> spp.	<i>H. meleagridis</i>	4	1, 4	2	2	2	2Ag	N/A
<i>Ichthyobodo</i> spp.	<i>I. Necator</i>	5	3	1	2	2	2Ag	N/A
<i>Ichthyophthirius</i> spp.	<i>I. multifiliis</i>	5	3	2	2	2	2Ag	N/A
<i>Isoospora</i> spp.	<i>I. burrowsi</i> , <i>I. canis</i> , <i>I. felis</i> , <i>I. ohioensis</i> , <i>I. neorivolta</i>	3, 4, 6c, 7, 10b	1	2	2	2	2Ag	N/A
<i>Ixodes</i> spp.	<i>I. pacificus</i> , <i>I. ricinus</i> , <i>I. scapularis</i>	1, 2, 3, 4, 6, 7, 8, 10	4	2	2	2	2Ag	N/A
<i>Leishmania</i> spp.	<i>L. braziliensis</i> , <i>L. chagasi</i> , <i>L. infantum</i>	2, 7, 10b	2	2	2	2	2Ag	Y
<i>Martellia</i> spp.	<i>M. refringens</i>	5d	6	1	2	2	2Ag	Y
<i>Metagonimus</i> spp.	<i>M. yokogawai</i>	5, 6, 7, 10b	6, 8	2	2	2	2Ag	N/A
<i>Metorchis</i> spp.	<i>M. conjunctus</i>	5, 6, 7, 10b	6, 8	2	2	2	2Ag	N/A
<i>Mikrocytos</i> spp.	<i>M. mackini</i>	5d	3, 4, 8	2	2	2	2Ag–3Ag	N/A
<i>Myxobolus</i> spp.	<i>M. cerebri</i>	5a	6	2	2	2	2Ag	N/A
<i>Nanophyetus</i> spp.	<i>N. salmincola</i> (<i>Trogloremma salmincola</i>)	6b, 7a	6	1	2	2	2Ag	N/A
<i>Necator</i> spp.	<i>N. americanus</i>	10b	1	2	2	2	2Ag	N/A
<i>Oestrus</i> spp.	<i>O. ovis</i>	1, 6a	2	2	2	2	2Ag	N/A
<i>Opisthorchis</i> spp.	<i>O. felinus</i> , <i>O. viverrini</i>	5, 6, 7, 10b	6, 8	2	2	2	2Ag	N/A
<i>Parafilaria</i> spp.	<i>P. bovicola</i>	1a	1, 6	2	2	2	2Ag	N/A
<i>Paragonimus</i> spp.	<i>P. kellicotti</i> , <i>P. miyazakii</i> , <i>P. westermani</i>	5, 7, 10b	6, 8	2	2	2	2Ag	N/A
<i>Perkinsus</i> spp.	<i>P. marinus</i> , <i>P. olensi</i>	5d	1, 3, 9	2	2	2	2Ag	Y
<i>Psoroptes</i> spp.	<i>P. ovis</i>	1	4	2	2	2	2Ag	Y
<i>Rhipicephalus</i> spp.	<i>R. annulatus</i> , <i>R. sanguineus</i>	1, 2, 3, 4, 6, 7, 8, 10	4	2	2	2	2Ag	N/A
<i>Sarcocystis</i> spp.	<i>S. cruzi</i> , <i>S. hirsuta</i> , <i>S. hominis</i>	1, 2, 3, 4, 6, 8, 10b	8	2	2	2	2Ag	N/A
<i>Sarcoptes</i> spp.	<i>S. scabiei</i>	7, 10b	4	2	2	2	2Ag	Y
<i>Taenia</i> spp.	<i>T. multiceps</i> , <i>T. saginata</i> , <i>T. solium</i>	3, 10b	6, 8	2	2	2	2Ag	N/A
<i>Theileria</i> spp.	<i>T. annulata</i> , <i>T. buffei</i> , <i>T. lestoquardi</i> , <i>T. luwenshuni</i> , <i>T. mutans</i> , <i>T. orientalis</i> , <i>T. parva</i> , <i>T. sergenti</i> , <i>T. uilenbergi</i>	1, 6a	2	2	2	2	2Ag–3Ag	Y
<i>Toxocara</i> spp.	<i>T. canis</i> , <i>T. cati</i>	7, 10b	1, 7	2	2	2	2Ag	N/A
<i>Toxoplasma</i> spp.	<i>T. gondii</i>	7b	8	2	2	2	2Ag	N/A
<i>Trichinella</i> spp.	<i>T. spiralis</i>	3, 6, 10b	8	2	2	2	2Ag	N/A
<i>Trichodina</i> spp.	N/A	5	3	1	2	2	2Ag	N/A
<i>Trichomonas</i> spp.	<i>T. fetus</i> , <i>T. gallinae</i> , <i>T. stableri</i>	4	1, 5	2	2	2	2Ag	Y

Continued on next page ►

Genus	Agent(s)	Hosts ¹	Routes ²	Stability ³	<i>In vitro</i> Cont.	<i>In vivo</i> Cont.	<i>In vivo</i> Ag Cont.	Other Regs
<i>Trichuris</i> spp.	<i>T. suis</i> , <i>T. trichiura</i> , <i>T. vulpis</i>	10b	1, 8	2	2	2	2Ag	N/A
<i>Tropilaelaps</i> spp.	<i>T. clareae</i> , <i>T. mercedesae</i>	9	6	2	2	2	2Ag	N/A
<i>Trypanosoma</i> spp.	<i>T. brucei</i> , <i>T. congolense</i> , <i>T. cruzi</i> , <i>T. equiperdum</i> , <i>T. evansi</i> , <i>T. vivax</i>	1, 2, 3, 6, 7, 8, 10	2, 4, 7	2	2	2	2Ag–3Ag	Y
<i>Uncinaria</i> spp.	<i>U. stenocephala</i>	7	1	2	2	2	2Ag	N/A
<i>Varroa</i> spp.	<i>V. destructor</i>	9	6	2	2	2	2Ag	N/A

Table 4. Viruses

Genus	Agent(s)	Hosts ¹	Routes ²	Stability ³	<i>In vitro</i> Cont.	<i>In vivo</i> Cont.	<i>In vivo</i> Ag Cont.	Other Regs
Adenoviridae	N/A	1–10	1,3	3	1–3	1–3	2Ag–3Ag	N/A
Arenaviridae	Lymphocytic Choriomeningitis Virus, Viral Hemorrhagic Fever	7, 8, 10	1,3,4,5, 7,8	2	2–4	2–4	2Ag–4Ag	Y
Asfarviridae	African Swine Fever Virus	3	4,5,8	2	2	2–3	3Ag	Y
Arteriviridae	Equine Viral Arteritis Virus, Porcine Reproductive and Respiratory Syndrome Virus	2, 3	2,3,4,5,7	2	2	2–3	2Ag–3Ag	Y
Astroviridae	Astrovirus	1, 3, 4, 6a, 7, 8, 10b	1	2	2	2	2Ag	N/A
Baculoviridae	Baculovirus penaei (Crustaceans), Penaeus monodon-type baculovirus (Crustaceans)	5c	1,3,4,7,8	2	2	2	2Ag	N/A
Birnaviridae	Infectious Bursal Disease Virus, Infectious Pancreatic Necrosis (Fish)	4a, 5a	1,3,4,7,9	2–3	2	2–3	2Ag	N/A
Bornaviridae	Borna Disease Virus	1, 2, 3, 4, 6, 7, 10	1,3,4,5,8	2	2	2	2Ag	N/A
Bunyaviridae	Akabane Virus, Cache Valley Virus, Crimean-Congo Hemorrhagic Fever Virus, Hantavirus, Nairobi Sheep Disease Virus, Rift Valley Fever Virus	1, 2, 3, 6, 7, 8, 9, 10	1,2,3,4, 5,8	1–2	2–4	2–4	2Ag–4Ag	Y
Caliciviridae	European Brown Hare Syndrome Virus, Hepatitis E Virus, Noroviruses, Rabbit Calicivirus Disease, Sapovirus, Vesicular Exanthema Virus of Swine	3, 4a, 5a, 6, 7, 8, 10b	1,2,4,5,8	2	2	2–3	2Ag–3Ag	Y
Circoviridae	Porcine Circovirus II	3	2,3,4	2	2	2	2Ag	N/A
Coronaviridae	Avian Infectious Bronchitis, Porcine Delta Coronavirus, Porcine Epizootic Diarrhea, SARS-Associated Coronavirus, Transmissible Gastroenteritis	3, 4a, 6, 10b	1,3,4,8	2	2	2–3	2Ag–3Ag	Y
Filoviridae	Viral Hemorrhagic Fever	10	1,3,4,5	2	4	4	2Ag–4Ag	Y

Continued on next page ►

Genus	Agent(s)	Hosts ¹	Routes ²	Stability ³	<i>In vitro</i> Cont.	<i>In vivo</i> Cont.	<i>In vivo</i> Ag Cont.	Other Reqs
Flaviviridae	Bovine Viral Diarrhea Virus, Classical Swine Fever Virus, Japanese Encephalitis Virus, Louping Ill Virus, Wesselsbron Disease Virus, West Nile Fever Virus	1, 2, 3, 4, 6, 7a, 9, 10b	1,2,3,4, 5,7,8	2-3	2-3	2-4	2Ag-3Ag	Y
Herpesviridae	Bovine Herpes Virus 1, Equine Herpes Virus, Gallid Herpesvirus 1, Gallid Alpha herpesvirus 2, Koi Herpesvirus, Malignant Catarrhal Fever Virus, Pseudorabies Virus	1, 2, 3, 4, 5, 6a	1,3,4,5,7	1-2	2-3	2-3	2Ag-3Ag	Y
Iridoviridae	Red Sea Bream Iridoviral Disease	5	4	2	2	2	2Ag	N/A
Nimaviridae	White Spot Syndrome Virus (Crustaceans)	5c	4,7	2	2	2	2Ag	N/A
Orthomyxoviridae	Avian Influenza Virus (highly pathogenic), Infectious Salmon Anemia Virus, Swine Influenza Virus, Syncytial Hepatitis of Tilapia	3, 4, 5, 6c	1,3,4,5	1-2	2-3	2-3	2Ag-3Ag	Y
Paramyxoviridae	Bovine Respiratory Syncytial Virus, Hendra Virus, Menangle Virus, Newcastle Disease Virus (Vologenic Strain), Nipah Virus, Peste Des Petits Ruminants Virus, Rinderpest Virus, Turkey Rhinotracheitis	1, 2, 3, 4, 6, 7, 10	1,3,4,5	1-3	2-4	2-4	2Ag-4Ag	Y
Parvoviridae	Infectious Hypodermal and Hematopoietic Necrosis (Crustaceans), Aleutian Mink Disease	5c	7,8	2	2	2	2Ag	Y
Picornaviridae	Duck Hepatitis Virus, Foot and Mouth Disease, Hepatitis A Virus, Swine Vesicular Disease Virus, Taura Syndrome Virus (Crustaceans), Teschen Disease Virus	1, 3, 4b, 5c, 6, 10b	1,3,4,5,8	2	2	2-3	2Ag-3Ag	Y
Poxviridae	Camelpox Virus, Capripoxvirus, Contagious Ecthyma, Monkeypox Virus, Myxoma Virus	1, 6, 7c, 10	2,3,4,5,9	2-3	2-4	2-4	2Ag-3Ag	Y
Reoviridae	African Horse Sickness Virus, Bluetongue Virus, Epizootic Hemorrhagic Disease Virus, Equine Encephalosis Virus, Rotavirus	2, 4a, 5, 6, 7a, 8	2,4,8	2	2	2-3	2Ag-3Ag	Y
Retroviridae	Bovine Leukemia Virus (Enzootic), Caprine Arthritis Encephalitis Virus, Equine Infectious Anemia Virus, Jembrana Virus, Maedi-Visna	1, 2, 6a	2,3,4,5,7	1-3	2-3	2-3	2Ag-3Ag	Y
Rhabdoviridae	Bovine Ephemeral Fever Virus, Epizootic Hematopoietic Necrosis (Fish), Infectious Hematopoietic Necrosis Virus (Fish), Rabies, Spring Viremia of Carp Virus, Vesicular Stomatitis Virus (exotic), Viral Hemorrhagic Septicemia Virus (Fish)	1, 2, 3, 5, 6, 7, 8, 10	1,2,3,4, 5,7,8	1-2	2-3	2-3	2Ag-3Ag	Y

Continued on next page ►

Genus	Agent(s)	Hosts ¹	Routes ²	Stability ³	<i>In vitro</i> Cont.	<i>In vivo</i> Cont.	<i>In vivo</i> Ag Cont.	Other Regs
Roniviridae	Yellowhead Virus (Crustaceans)	5c	1,4	2	2	2	2Ag	N/A
Togaviridae	Eastern Equine Encephalitis Virus, Getah Virus, Venezuelan Equine Encephalitis Virus, Western Equine Encephalomyelitis Virus	2, 3, 8, 10	2,3	2	2-3	2-3	2Ag-3Ag	Y

Table 5. Toxins

Toxin(s)	Hosts ¹	Routes ²	Stability ³	<i>In vitro</i> Cont.	<i>In vivo</i> Cont.	<i>In vivo</i> Ag Cont.	Other Regs
Botulinum Neurotoxin	1a, 2, 4, 6c, 10b	8	2	2	2	2Ag	Y
<i>Clostridium perfringens</i> epsilon toxin	1, 3, 4a, 10b	3,8	2-3	2	2	2Ag	N/A
Shiga toxin	10b	8	3	2	2	3Ag	
Staphylococcal enterotoxin (B, C)	10b	8	3	2	2	3Ag	Y
T-2 Toxin	1, 3, 4, 5, 10b	8	2	2	2	2Ag	Y

Table 6. Prions

Disease(s)	Hosts ¹	Routes ²	Stability ³	<i>In vitro</i> Cont.	<i>In vivo</i> Cont.	<i>In vivo</i> Ag Cont.	Other Regs
Bovine Spongiform Encephalopathy	1,7b,10	8	3	2	2	2Ag-3Ag	Y
Scrapie	1b,1c	7	3	2	2	2Ag	Y
Chronic Wasting Disease	6a	1,5,7	2	2	2	2Ag	Y

Table Key 1. Natural Host Range

Designation	Meaning
1	Ruminant (multiple species)
1a	Bovine
1b	Caprine
1c	Ovine
1d	Camelids
2	Equine
3	Porcine (domestic and feral)
4	Domestic Fowl (multiple species)

Continued on next page ►

Designation	Meaning
4a	Chicken
4b	Duck
4c	Turkey
4d	Geese
4e	Ratites (e.g., ostriches, emus)
5	Aquatic (multiple species)
5a	Salmonids
5b	Catfish
5c	Crustaceans
5d	Mollusks
6	Wildlife (multiple species)
6a	Wild Ruminant (e.g., wildebeests, buffalo, cervids)
6b	Wild Carnivores (e.g., wolf, coyote, raccoon)
6c	Wild Fowl
6d	Wild Lagomorphs
6e	Wild and Captive Amphibians
6f	Wild and Captive Reptiles
6g	Bats
7	Domestic Companion Animals (multiple species, including hamsters, gerbils, guinea pigs, non-laboratory mice/rats)
7a	Canine
7b	Feline
7c	Domestic Lagomorphs
7d	Ferrets
8	Rodent (multiple species)
9	Insects (honeybees)
10	Primates (humans and non-human)

Continued on next page ►

Designation	Meaning
10a	Non-human Primates
10b	Humans

Table Key 2. Natural Routes of Transmission

Designation	Meaning
1	Fecal-Oral
2	Arthropod Vector (e.g., ticks, lice, fleas, crustaceans, mosquitos)
3	Aerosol Transmission (e.g., sneezing, coughing, nasal discharges, dust, particulates, water transmission in aquatic species)
4	Mechanical/Bloodborne (e.g., needles, palpation sleeves, injuries, direct contact, poxviruses)
5	Secretions (e.g., milk, saliva, semen, vaginal secretions)
6	Intermediate Host (e.g., snails, tissue cysts [required for transmission])
7	Vertical Transmission (e.g., transplacental, mother-to-offspring)
8	Ingestion (e.g., toxins, grazing, contaminated feed)
9	Varies or Highly Variable (i.e., when route is dependent on environmental or host factors)

Table Key 3. Environmental Stability

Designation	Meaning
1	Readily inactivated by desiccation, direct sunlight, composting, exposure to normal temperature fluctuations, and/or eliminate access to arthropod vectors and intermediate hosts.
2	Inactivation requires commercial disinfectants, detergents, temperature extremes (pasteurization), or steam. For tick-borne diseases, stability reflects tick persistence.
3	Inactivation requires specialized procedures (e.g., irradiation, incineration, bacteriophages, ultrasound, oxidation, mechanical stress, significant alterations of pH).

References

1. Miller JM, Astles R, Baszler T, Carey R, Garcia L, Gray L, et al. Guidelines for Safe Work Practices in Human and Animal Medical Diagnostic Laboratories. Recommendation of a CDC-Convened, Biosafety Blue Ribbon Panel. *MMWR Suppl.* 2012;61(1):1–102.

2. Testing and Performance-Verification Methodologies for Ventilation Systems for Biological Safety Level 3 (BSL-3) and Animal Biological Safety Level 3 (ABSL-3) Facilities, ANSI/ASSE Z9.14 (2014).
3. 9.1 General. In: United States Department of Agriculture. ARS Facilities Design Standards. Washington (DC): USDA ARS; 2012. p. 223–5.
4. 9.2 Hazard Classification and Choice of Containment. In: United States Department of Agriculture. ARS Facilities Design Standards. Washington (DC): USDA ARS; 2012. p. 226.
5. 9.3 Primary Barriers (Containment Equipment). In: United States Department of Agriculture. ARS Facilities Design Standards. Washington (DC): USDA ARS; 2012. p. 227.
6. 9.4 Secondary Barriers (Facility Design Features). In: United States Department of Agriculture. ARS Facilities Design Standards. Washington (DC): USDA ARS; 2012. p. 228–44.
7. 9.5 Special Design Issues. In: United States Department of Agriculture. ARS Facilities Design Standards. Washington (DC): USDA ARS; 2012. p. 245–53.
8. Appendix 9B: Testing and Certification Requirements for the Critical Components of Biological Containment Systems. In: United States Department of Agriculture. ARS Facilities Design Standards. Washington (DC): USDA ARS; 2012. p. 268–74.

Appendix E—Arthropod Containment Guidelines (ACG)

An ad hoc committee of concerned vector biologists including members of the American Committee of Medical Entomology (ACME), a subcommittee of the American Society of Tropical Medicine and Hygiene (ASTMH), and other interested persons drafted the original Arthropod Containment Guidelines (ACG) in 2003.¹ The guidelines provide principles and practices for risk assessment for research on arthropods of public health importance. The risk assessment and practices in the ACG are designed to be consistent with the *NIH Guidelines* for recombinant DNA research and the BMBL.

The ACG were published in hard copy in the March 2019 issue of *Vector-Borne Zoonotic Diseases*² and are freely downloadable from <https://www.liebertpub.com/doi/10.1089/vbz.2018.2431>.

The ACG recommend biosafety measures specific for arthropods of public health importance considering that:

- Arthropods present unique containment challenges not encountered with microbial pathogens; and
- Arthropod containment has not been covered specifically in BMBL or the *NIH Guidelines*.

The ACG contain two sections of significant interest to most researchers:

- The Principles of Risk Assessment that discusses arthropods in the usual context (e.g., those known to contain a pathogenic agent, those with uncertain pathogens, and those with no agent). Arthropod risk assessment is primarily a qualitative judgment that cannot be based on a prescribed algorithm. Several factors must be considered in combination: the agents transmitted, whether the arthropod is or may be infected, the mobility and longevity of the arthropod, its reproductive potential, biological containment, and epidemiological factors influencing transmission in the proposed location or region at risk.
- Factors considered in Arthropod Containment Level (ACL) classification include:
 - Biological containment is a significant factor that reduces the hazards associated with accidental escape of arthropods;
 - Epidemiological context alters the risks of an escape and its impact on the location or site in which the work is performed;
 - The phenotype of the vector, such as insecticide resistance; and
 - Genetically modified arthropods with an emphasis on phenotypic change.

Four Arthropod Containment Levels (ACL 1–4) add increasingly stringent measures and are similar to Biosafety Levels. The most flexible level is ACL-2, which covers most exotic and transgenic arthropods and those infected with pathogens requiring BSL-2 containment. Like the BMBL, each level has four components, with the following similar format:

- Standard practices;
- Special practices;
- Equipment (primary barriers); and
- Facilities (secondary barriers).

The ACG do not reflect a formal endorsement by ACME or ASTMH. The guidelines are subject to change based on further consideration of the requirements for containment of arthropods and vectors.

References

1. American Committee of Medical Entomology; American Society of Tropical Medicine and Hygiene. Arthropod containment guidelines. A project of the American Committee of Medical Entomology and American Society of Tropical Medicine and Hygiene. *Vector Borne Zoonotic Dis.* 2003;3:61–98.
2. American Committee of Medical Entomology; American Society of Tropical Medicine and Hygiene. *Vector-Borne and Zoonotic Diseases*. New Rochelle (NY): Mary Ann Liebert, Inc.; 2019.

Appendix F—Select Agents and Toxins

Following the anthrax attacks of 2001 that resulted in five deaths, Congress significantly strengthened federal oversight of biological agents and toxins that have the potential to pose a severe threat to public health; animal and plant health; and animal and plant products (Select Agents and Toxins). The Public Health Security and Bioterrorism Preparedness and Response Act of 2002 (Bioterrorism Response Act) required the Department of Health and Human Services (HHS) to regulate the possession, use, and transfer of select biological agents and toxins that have the potential to pose a severe threat to public health and safety. Subtitle B of Title II of the Bioterrorism Response Act (cited as the Agricultural Bioterrorism Protection Act of 2002) granted comparable regulatory authorities to the U.S. Department of Agriculture (USDA) over select biological agents and toxins that have the potential to pose a severe threat to animal and plant health or products. The Bioterrorism Response Act also requires HHS and USDA to coordinate activities regarding the zoonotic agents regulated by both Departments.

These activities are implemented through the Federal Select Agent Program (FSAP). FSAP is managed jointly by the Centers for Disease Control and Prevention's (CDC) Division of Select Agents and Toxins (DSAT) and the Animal and Plant Health Inspection Service's (APHIS) Agriculture Select Agent Services (AgSAS). FSAP regulates the acquisition, use, storage and transfer of Select Agents and Toxins through the development, implementation, and enforcement of the federal Select Agent regulations—7 CFR Part 331 (APHIS-PPQ), 9 CFR Part 121 (APHS-VS), and 42 CFR Part 73 (CDC).

FSAP provides national oversight of the safety and security of potentially dangerous biological Select Agents and Toxins. Key elements of the Select Agent regulations include:

- All entities that possess, use, or transfer Select Agents and Toxins must be registered with FSAP.
- All individuals who have access to Select Agents and Toxins must first be approved by FSAP after a security risk assessment (SRA) performed by the Federal Bureau of Investigation's (FBI) Criminal Justice Information Services Division (CJIS) to help guard against access to the agents and toxins by those who may wish to misuse them.
- Enforcement actions for regulatory violations may be taken to address present risks and increase future compliance through administrative actions and/or civil monetary penalties. An entity may be referred to the HHS Office of the Inspector General (OIG) or APHIS Investigative and Enforcement Services (IES), or the FBI may be notified of the incident for potential further investigation, as appropriate.

- An entity's registration may be denied, suspended, or revoked if it is determined that such action is necessary to protect human, animal, or plant health, or animal or plant products.
- Each registered entity must designate a Responsible Official (RO), an individual with the authority and responsibility to act on behalf of the entity and charged with ensuring compliance with the Select Agent regulations. The RO is able to respond to onsite incidents involving Select Agents in a timely manner, ensures annual inspections are conducted for each space where Select Agents are stored or used, reviews the entity's validated inactivation procedures and investigates any failures, and reports the identification and final disposal of any Select Agent or Toxin in a diagnostic specimen or proficiency test. Alternate Responsible Official(s) (ARO) may be designated to serve when the RO is not available; AROs have the same responsibilities as ROs.
- Each registered entity must develop and implement a written security plan sufficient to safeguard their Select Agents and/or Toxins against unauthorized access, theft, loss, or release.
- Each registered entity must develop and implement a written biosafety plan commensurate with the risk of their Select Agents and/or Toxins, given their intended use.
- A registered entity must receive pre-approval for *Restricted experiments* that pose heightened safety and security risks. See Section 13 of the Select Agents and Toxins regulations for additional information.
- Each registered entity must develop and implement a written incident response plan specific to the hazards associated with their Select Agents and/or Toxins.
- Each registered entity must provide information and training on biosafety, security, and incident response to individuals with access to Select Agents and Toxins.
- Any instances of the theft, loss, or release of a Select Agent or Toxin must be promptly reported to FSAP in accordance with the Select Agent and Toxin regulations.
- An entity may only transfer a Select Agent or Toxin to another entity registered to possess that agent or toxin, and the transfer must be preauthorized by FSAP.
- Each registered entity must maintain complete records and documentation including, but not limited to: inventories, exposures, lists of individuals with approved access, and entry into areas containing Select Agents or Toxins.
- FSAP may conduct inspections of an entity without prior notification and prior to issuing a certificate of registration.

- There are specific exemptions or exclusions to the regulations including specific attenuated strains or Select Toxins modified to be less potent or toxic.
- Entities must use validated inactivation procedures to inactivate Select Agents. Please refer to the appendix on Inactivation and Verification.

As of January 2017, FSAP regulates 66 Select Agents and Toxins. The list of Select Agents and Toxins is reviewed at least every two years to determine if agents or toxins need to be added to or deleted from the list.

For more information on the regulations and guidance documents for implementation of a Select Agent program, please visit <https://www.selectagents.gov>.

Appendix G—Integrated Pest Management (IPM)

Integrated Pest Management (IPM) is an important part of managing a research facility. Many pests, including flies and cockroaches, can mechanically transmit disease pathogens and compromise the research environment. Even the presence of innocuous insects can contribute to the perception of unsanitary conditions.

The most common approach to pest control has been the application of pesticides, either as a preventive or remedial measure. Pesticides can be effective and may be necessary as a corrective measure, but they have limited long-term effects when used alone. Pesticides also can contaminate the research environment through pesticide drift and volatilization.

To manage pests and minimize the use of pesticides, it is necessary to employ a comprehensive program approach that integrates housekeeping, maintenance, and pest control services. This method of pest control is often referred to as IPM. The primary goal of an IPM program is to prevent pest problems by managing the facility environment to make it less conducive to pest infestation. Along with limited applications of pesticides, pest control is achieved through proactive operational and administrative intervention strategies to correct conditions that promote pest problems.

Prior to developing any type of IPM program, it is important to define an operational framework process for IPM services that also helps promote collaboration between IPM specialists and facility personnel. This framework should incorporate facility restrictions as well as operational and procedural issues into the IPM program. An effective IPM program is an integral part of the facility's management. An IPM policy statement should be included in the facility's standard operating procedures to increase awareness of the program.

Training sources for the principles and practices of structural (indoor) IPM programs are available through university entomology departments, county extension offices, the Entomological Society of America, state departments of agriculture, state pest control associations, the National Pest Management Association (NPMA), suppliers of pest control equipment, and IPM consultants and firms. Several universities offer correspondence courses, short courses, and training conferences on structural pest management.

IPM is a strategy-based approach that considers not only the cost of the services but also the effectiveness of the program's components. Each IPM program is site-specific and tailored to the environment where applied.

Laboratory IPM services are different from those in an office building or an animal care facility. Interrelated components of environmental pest management follow.

Facility Design IPM issues and requirements should be addressed in a research facility's planning, design, construction, and retrofitting. This provides an opportunity to incorporate features that help exclude pests, minimize pest habitat, and promote proper sanitation in order to reduce future corrections that can disrupt research operations. Examples can be obtained from the National Institutes of Health Design Requirements Manual at <https://www.orf.od.nih.gov/TechnicalResources/Documents/DRM/DRM1.4042419.pdf>.

Monitoring Monitoring is the central activity of an IPM program and is used to minimize pesticide use. Traps, visual inspections, and staff interviews identify areas and conditions that may foster pest activity.

Sanitation and Facility Maintenance Many pest problems can be prevented or corrected by ensuring proper sanitation, reducing clutter and pest habitat, and by performing repairs that exclude pests. Records of structural deficiencies and housekeeping conditions should be maintained to track problems and determine if corrective actions were carried out and completed in a timely manner.

Communication A staff member should be designated to meet with IPM personnel to assist in resolving facility issues that impact pest management. Reports communicated verbally and in writing concerning pest activity and improvement recommendations for personnel, practices, and facility conditions should be provided to the designated personnel. Facility personnel should receive training on pest identification, biology, and sanitation, which can promote understanding and cooperation with the goals of the IPM program.

Recordkeeping A logbook should be used to record pest activity and conditions pertinent to the IPM program. It may contain protocols and procedures for IPM services in that facility, Safety Data Sheets on pesticides, pesticide labels, treatment records, floor plans, and survey reports.

Non-pesticide Pest Control Pest management methods such as trapping, exclusion, caulking, washing, heating, and freezing can be applied safely and effectively when used in conjunction with proper sanitation and structural repair.

Pest Management with Pesticides Preventive applications of pesticides should be discouraged, and treatments should be restricted to areas of known pest activity. When pesticides are applied, the least toxic product(s) available should be used and applied in the most effective and safe manner. Fogging should be avoided.

Program Evaluation and Quality Assurance Quality assurance and program review should be performed to provide an objective, ongoing evaluation of IPM activities and effectiveness to ensure that the program does, in fact, manage pests and meet the specific needs of the facility program(s) and its occupants. Based on this review, current IPM protocols can be modified and new procedures implemented.

Technical Expertise A qualified entomologist can provide helpful technical guidance to develop and implement an IPM program. Pest management personnel should be licensed and certified by the appropriate regulatory agency(s).

Safety IPM minimizes the potential of pesticide exposure to the research environment and the staff by limiting the scope of pesticide treatments.

References

1. Bennett GW, Owens JM, editors. *Advances in urban pest management*. New York: Van Nostrand Reinhold Company; 1986.
2. Biocontrol Network [homepage on the Internet]. Murfreesboro (TN): Biocontrol Network; c2018 [cited 2018 Sept 25]. Available from: <http://www.biconet.com>.
3. National Institutes of Health, Office of Management, Office of Research Facilities [Internet]. Bethesda (MD): Design Requirements Manual (DRM); c2018 [cited 2018 Sept 25]. Available from: <https://www.orf.od.nih.gov/TechnicalResources/Documents/DRM/DRM1.4042419.pdf>
4. National Pest Management Association [homepage on the Internet]. Fairfax (VA): NPMA Pestworld; c2018 [cited 2018 Sept 25]. Available from: <http://nmapestworld.org>.
5. Olkowski W, Daar S, Olkowski H. *Common-sense pest control: least-toxic solutions for your home, garden, pests and community*. Newton (CT): The Taunton Press, Inc.; 1991.
6. Robinson WH. *Urban entomology: insect and mite pests in the human environment*. New York: Chapman and Hall; 1996.
7. Robinson, WH. *Urban Insects and Arachnids: a handbook of urban entomology*. New York: Cambridge University Press; 2011.

Appendix H—Working with Human, Non-Human Primate (NHP), and Other Mammalian Cells and Tissues

As with any other type of laboratory activity, a risk assessment should preface work with eukaryotic cell cultures. Such work is generally considered low-risk, but risk increases when working with human and other primate cell lines and with primary cells from other mammalian species in the laboratory. This standard recognizes that employees in both research and clinical work settings face inherent risks working with human materials. Microbiological and biomedical researchers can minimize or eliminate these risks using a combination of engineering and work practice controls, personal protective clothing, safety equipment, training, medical surveillance, vaccination, signs and labels, and other provisions.

Bloodborne pathogens and risk assessment related to material source and type

Bloodborne pathogens are pathogenic microorganisms present in human blood and other potentially infectious materials (OPIM), which can infect and cause disease in persons who are exposed to blood containing these pathogens. Hepatitis B virus (HBV), hepatitis C virus (HCV), and human immunodeficiency virus (HIV) are the most common examples of such microorganisms. Work with blood and OPIM involves risk of exposure not only to these agents, but also other opportunistic pathogens transmitted primarily by other routes (e.g., contact, droplet, and airborne) that may be present in blood or the sample material at the time it is being handled. For example, *Mycobacterium tuberculosis* may be transmitted via the airborne route and primarily present in human lung tissues, while bacterial species such as Staphylococci may be contact transmitted but present in localized tissues or blood during acute infections. Prions, responsible for spongiform encephalopathies and other diseases, may be more concentrated in neural tissues rather than blood, whereas viral hemorrhagic fever-causing viruses can be considered bloodborne pathogens but are often present in other body fluids, such as urine.¹ Numerous pathogens can be present in human materials and each agent may have a number of different characteristics to consider pertaining to the process of infection. For this reason, a risk assessment must be performed that takes into account material source, type, characteristics, and the procedures being performed with the material.

Working with human, NHP, and other mammalian cell lines may present a risk of exposure to bloodborne pathogens, as widely recognized and documented in research and healthcare settings; guidance on how to respond to potential exposures is available.²⁻⁴ For institutions in the United States, the Occupational Safety and Health Administration (OSHA) has developed a bloodborne

pathogens standard that must be applied to all work with human blood and OPIM, including body fluids, tissues, and primary cell lines.⁵

Tissue Source Each institution should conduct a risk assessment, which can begin by appreciating the tissue source (species origin). The closer the relationship of the material is to humans, the higher the risk since pathogens usually have evolved species-specific requirements. Old World non-human primate (NHP) specimens (i.e., macaques) may contain Macacine herpesvirus (Herpes B) and Simian Immunodeficiency Virus (SIV). This material should always be considered potentially infected and should be handled with strict barrier precautions and with swift occupational responses for potential exposures. Herpes B virus infection in macaques is usually symptom-free, or causes only mild oral lesions, but in humans, the infection can be fatal.⁶ Also, consider that some pathogens can cross between species (e.g., influenzas, SARS Co-V, West Nile virus). Working with other (non-human and non-NHP) mammalian, avian, and invertebrate cell lines generally presents lower risks.

Cell or Tissue Type Another important consideration is cell or tissue type and whether there is a hazard associated with the capability of the cell to form tumors (e.g., oncogene expressing). Hematopoietic cells and lymphoid tissues can have tumorigenic potential and therefore have an increased risk for handling. Neural tissues and endothelial cells may be considered to have less risk, but an assessment must determine the probability of whether such cells contain other adventitious agents and take into account the tissue or cell source(s) and parameters related to the history of that source. Epithelial cells and fibroblasts present the lowest risk in terms of cell type and tumorigenic potential.⁷

Culture Type When working with cell lines, the culture type is another important consideration. Primary cell lines are derived by sampling directly from *in vivo* organ and tissue samples and have a higher risk of containing undetected pathogens. Therefore, these culture types have shorter lifespans of unknown characterization and present a higher potential risk while culturing. Continuous cell lines (i.e., cells immortalized with viral agents such as EBV, SV-40, or other viral agents) have been modified to grow for extended passages, perhaps even indefinitely. Continuous cultures can usually be more characterized with PCR and cytometric analyses; however, cells carrying viral genomic material still can pose increased risks in the event of inadvertent exposures, particularly for immune-compromised individuals.⁸ There has been a report of tumor development from an accidental needlestick injury.⁹ Permissive cell lines that support viral replication may have a heightened risk of contamination with viral pathogens. Well-established, and possibly even tested, cell lines are generally considered safer, but the possibility of adventitious contamination by an

unspecified pathogen during use must be considered during the risk assessment process, and measures must be taken to lower the risk of contamination.¹⁰

Additional Considerations When conducting a risk assessment, consider if endogenous pathogens are present in the specimen or if the pathogens have been added intentionally. Another key consideration is if agents may have been added as a result of passaging of the line in animal model systems. Experimentally infected cell lines should be handled following safety recommendations for both potential endogenous pathogens and known pathogens added in the course of research. Any cell line with known endogenous pathogens should be handled following the safety recommendations for those pathogens. Risk assessment should also consider if any recombinant materials are expressed by the cell line and whether the cell line is a type that supports viral replication. Consult with the Institutional Biosafety Committee, or equivalent resource, when working with recombinant or synthetic nucleic acids in cell lines.¹¹ Helpful guidelines exist to increase awareness of the problems encountered when working with cells in biomedical research and how to address them effectively.¹²

Risk Mitigation

At a minimum, human and other primate cells should be treated as potentially infectious and handled using BSL-2 practices, engineering controls, and facilities.¹³ The use of a biological safety cabinet (BSC) for culturing activities is the universally accepted best practice. Higher containment must be considered for cell lines harboring Risk Group 3 and 4 pathogens as indicated by the risk assessment; higher containment must be considered if the agents present become airborne when energy is imparted on the biological sample. Personal protective equipment (PPE) such as laboratory coats, gloves, and eye protection should be worn in tissue culture laboratories and additional PPE should be added as indicated by risk assessment. All waste culture material must be decontaminated before disposal. All laboratory staff working with human and NHP cells and tissues should be enrolled in an occupational medical program specific for bloodborne pathogens, and staff should work under the policies and guidelines established by their institution's Exposure Control Plan (ECP).

Please refer to [Section II](#) for additional information about the risk assessment process and risk mitigation.

References

1. Kuhn JH, Clawson AN, Radoshitzky SR, Wahl-Jensen V, Bavari S, Jahrling PB. Viral Hemorrhagic Fevers: History and Definitions. In: Singh SK, Ruzek D, editors. *Viral Hemorrhagic Fevers*. Boca Raton (FL): CRC Press; 2013. p. 3–13.

2. Siegel JD, Rhinehart E, Jackson M, Chiarello L; Healthcare Infection Control Practices Advisory Committee. 2007 Guideline for Isolation Precautions: Preventing Transmission of Infectious Agents in Health Care Settings. *Am J Infect Control*. 2007;35(10):S65–S164.
3. Kuhar DT, Henderson DK, Struble KA, Heneine W, Thomas V, Cheever LW, et al. Updated U.S. Public Health Service Guidelines for the Management of Occupational Exposures to Human Immunodeficiency Virus and Recommendations for Postexposure Prophylaxis. *Infect Control Hosp Epidemiol*. 2013;34(9):875–92. Erratum in: *Infect Control Hosp Epidemiol*. 2013;34(11):1238.
4. US Public Health Service. Updated U.S. Public Health Service Guidelines for the Management of Occupational Exposures to HBV, HCV, and HIV and Recommendations for Postexposure Prophylaxis. *MMWR Recomm Rep*. 2001;50(RR-11):1–52.
5. Bloodborne pathogens, 29 C.F.R. Part 1910.1030 (1992).
6. NASPHV; Centers for Disease Control and Prevention; Council of State and Territorial Epidemiologists; American Veterinary Medical Association. Compendium of measures to prevent disease associated with animals in public settings, 2009: National Association of State Public Health Veterinarians, Inc. (NASPHV). *MMWR Recomm Rep*. 2009;58(RR-5):1–21.
7. Pauwels K, Herman P, Van Vaerenbergh B, Dai Do Thi C, Berghmans L, Waeterloos G, et al. Animal Cell Cultures: Risk Assessment and Biosafety Recommendations. *Apple Biosaf*. 2007;12(1):26–38.
8. Caputo JL. Safety Procedures. In: Freshney RI, Freshney MG, editors. *Culture of Immortalized Cells*. New York: Wiley-Liss; 1996. p. 25–51.
9. Gugel EA, Sanders ME. Needle-stick transmission of human colonic adenocarcinoma [letter]. *N Engl J Med*. 1986;315(23):1487.
10. McGarrity GJ. Spread and control of mycoplasmal infection of cell culture. *In Vitro*. 1976;12(9):643–8.
11. National Institutes of Health. NIH Guidelines for Research Involving Recombinant or Synthetic Nucleic Acid Molecules (NIH Guidelines). Bethesda (MD): National Institutes of Health, Office of Science Policy; 2019.
12. Geraghty RJ, Capes-Davis A, Davis JM, Downward J, Freshney RI, Knezevic I, et al. Guidelines for the use of cell lines in biomedical research. *Br J Cancer*. 2014;111(6):1021–46.
13. United States Department of Labor [Internet]. Washington (DC): Occupational Safety and Health Administration; c1994 [cited 2019 April 10]. Applicability of 1910.1030 to establish human cell lines. Available from: https://www.osha.gov/pls/oshaweb/owadisp.show_document?p_table=INTERPRETATIONS&p_id=21519

Appendix I—Guidelines for Work with Toxins of Biological Origin

Biological toxins encompass a vast range of peptides, small molecules, and macromolecular proteins that cause disease by interfering with biological processes. As their name suggests, biological toxins reside between traditional definitions of biological and chemical agents. They are produced by living organisms, are unable to replicate, and do not result in communicable diseases. The production of novel or existing toxins by synthetic means is becoming increasingly accessible.^{1,2} Many biological toxins have been evolutionarily optimized to rapidly disrupt critical biological functions at low concentrations. Their extraordinary, highly specific toxicity is mediated through a diverse set of mechanisms, including enzymatic activity against critical cellular targets, blockade of membrane ion channels and receptors, and perturbation of essential cellular functions. The remarkable combination of specificity and potency has resulted in the widespread use of diverse biological toxins for clinical and research purposes, including botulinum neurotoxins, tetrodotoxin, conotoxins, scorpion toxins, snake venom toxins, and immunotoxins. Because laboratory workers in a wide range of medical and scientific disciplines are likely to encounter biological toxins at some point during their career, it is critically important that laboratory workers understand and are able to assess the risks associated with their use.

Laboratory workers can be exposed to biological toxins through a variety of routes, including inhalation of powders, aerosols, or volatile substances; ingestion; injection; and absorption through dermal, mucosal or ocular tissues. Many biological toxins are highly potent, and internalization of even relatively low doses may result in death or severe incapacitation. Consequently, it is critically important for those working with biological toxins to understand and implement appropriate laboratory safety principles. A number of principles for the safe use of many toxins commonly encountered in the clinical or research environment are summarized below, including for those biological toxins regulated by the Federal Select Agent Program as Select Toxins (see below).

General Considerations for Toxin Use

The primary risks during laboratory use of biological toxins result from accidental injection, absorption through skin or mucous membranes, inhalation, and ingestion. Laboratory work with most toxins in amounts routinely employed in the biomedical sciences can be performed safely with minimal risk to the worker and negligible risk to the surrounding community. Under most circumstances, toxins can be handled using established general guidelines for toxic or highly-toxic chemicals with the incorporation of additional safety and security measures

based upon a risk assessment for each specific toxin and laboratory operation.^{3,4} Additionally, the mixed hazard nature of toxins and their associated organisms should be considered in the risk assessment when determining appropriate facilities, practices, and equipment use for situations where both biological and chemical hazards are present. Standard use of engineering controls (e.g., Class II or Class III biosafety cabinets or open-front chemical fume hoods) and personnel protective equipment (e.g., safety glasses or goggles, mask, gloves, and lab coat) are generally sufficient to avoid accidental inhalation or topical exposure.

Training and Laboratory Planning

Each laboratory worker must be trained in the theory and practice of the toxins to be used, with special emphasis on the nature of the practical hazards associated with laboratory operations. These include risks associated with transfer of solubilized toxins; manipulation of waste solutions, contamination of materials and equipment; and decontamination after routine operations and spills. Workers must be well-trained and sufficiently adept at all laboratory procedures and safety practices before participating in toxin operations.

A risk assessment should be conducted to identify potential hazards and develop safe operating procedures before undertaking toxin operations. For example, the use of pre-operational checklists is highly recommended.⁴ For complex operations, newly approved toxin workers should undergo supervised practice runs in which the exact laboratory procedures to be undertaken are rehearsed using nontoxic simulants. Technical rehearsals are particularly important to mitigate the psychological stress of working with highly dangerous agents.

The inclusion of toxins can significantly complicate otherwise routine laboratory procedures. For example, equipment with potential to produce aerosols may need to be placed in primary containment, such as a biosafety cabinet (BSC) or fume hood, and decontaminated after each use. The use of personal protective equipment (PPE) can reduce dexterity, and operations may be more difficult when conducted in crowded hoods or BSCs. If toxins and infectious agents are used together, then both must be considered in the risk assessment when selecting containment equipment, developing safety procedures, and choosing decontamination and disposal methods. Early endpoints need to be designed to balance experimental objectives with safe and ethical application of toxins to animals. The medical consequences of an accidental needlestick during animal operations may be significantly increased when toxin is involved. Team leaders should be prepared to carefully review study procedures to identify how toxin use may interfere with experimental execution and develop effective mitigation strategies.

Each laboratory that uses toxins must develop toxin-specific chemical hygiene plans. The National Research Council has provided a review entitled “Prudent Practices in the Laboratory: Handling and Management of Chemical Hazards” with guidance on development of chemical hygiene plans and compliance with regulations governing occupational safety and health, hazard communication, and environmental protection. The 2011 edition of this review can be downloaded for free from <https://www.nap.edu/catalog/12654/prudent-practices-in-the-laboratory-handling-and-management-of-chemical>. These procedures are also summarized in the Occupational Safety and Health Administration’s Laboratory Standard (29 CFR Section 1910.1450, Appendix A).

A number of engineering and human controls are available to decrease the risk of accidental misuse of biological toxins. An inventory control system should be established and audited on a regular basis (e.g., monthly or quarterly) to account for toxin quantity, use, and disposition. While an inventory control system is required for users of non-exempt quantities of Select Toxins (see below for exempt quantity limits), it is also useful for ensuring that exempt quantity users do not accidentally exceed permissible toxin limits. For additional information select toxin exemption requirements, see the Federal Select Agent Program website (www.selectagents.gov). Toxins should be stored in storage containers with labels that clearly list the toxin contents, points of contact for trained, responsible laboratory staff, and emergency contact information. The use of locks on storage containers offers an additional level of oversight and control over toxin access. Laboratory work with toxins should only be done in designated rooms with controlled access and at pre-determined bench areas. When toxins are in use, the room should have clearly posted signage stating, for example, “Toxins in Use—Authorized Personnel Only.” Signage should provide a knowledgeable point of contact and delineate minimum requirements for PPE. Whenever possible, unrelated and nonessential work should be avoided in laboratory or clinical areas where concentrated solutions of toxins or of toxin-producing organisms are maintained. Laboratory visitors must be briefed and monitored to prevent them from inadvertently handling contaminated laboratory equipment or touching exposed surfaces without protection. Finally, treatment plans for accidental exposures should be prepared and available to emergency responders and, when possible, coordinated with primary care facilities. While there is no way to completely eliminate the dangers of biological toxin use, implementation of these controls can significantly reduce the risks associated with toxin storage and use.

Safety Equipment and Containment

Routine operations with dilute toxin solutions are conducted under BSL-2 conditions with the aid of PPE and a well-maintained BSC, chemical fume

hood, or comparable engineering controls.⁵ Engineering controls should be selected according to the risk assessment for each specific toxin operation. A certified BSC or chemical fume hood will suffice for routine operations with most solubilized protein toxins. Work involving toxin powders, volatile chemicals, or radionuclides combined with toxin solutions may require additional safeguards or barriers based on the risks associated with each toxin preparation.

Handling of solubilized toxins should be conducted within the operationally effective zone of a BSC or chemical fume hood. Before initiating work, each user should verify the hood or BSC is properly working according to manufacturer guidelines. When using a BSC or hood, workers should wear suitable laboratory PPE to protect the hands, arms, and eyes, such as laboratory coats with knit or elastic cuffs, smocks or coveralls, disposable gloves, and safety glasses. When working with toxins that pose direct percutaneous hazards, special care must be taken to select gloves that are impervious to the toxin and the diluents or solvents employed. When conducting large volume liquid transfers and other operations that pose a potential splash or droplet hazard in an open-front hood or BSC, workers should wear a disposable facemask or face shield.

Toxin(s) should be removed from the hood or BSC only after the exterior of the closed primary container has been decontaminated and placed in a clean secondary container. Toxin solutions, especially concentrated stock solutions, should be transported in leak/spill-proof secondary containers. The interior of the hood or BSC should be decontaminated periodically; for example, at the end of the day or after a spill. Until thoroughly decontaminated, the hood or BSC should remain posted to indicate that toxins are present, and access should be restricted to staff trained in toxin use and decontamination.

Selected operations with toxins may require modified BSL-3 practices and procedures. The determination to use BSL-3 is made in consultation with available biosafety staff and is based upon a risk assessment that considers the variables of each specific laboratory operation, especially the toxin under study, the physical state of the toxin (solution or dry form), the total quantity of toxin used relative to the estimated human median lethal dose, the volume of the material manipulated, the methodology, and any human or equipment performance limitations.

Inadvertent Toxin Aerosols

Many biological toxins are highly potent, and emphasis must be placed on evaluating and modifying experimental procedures to avoid inadvertent generation of toxin aerosols. Tubes containing solubilized toxin under pressure should be only be opened in a BSC, chemical fume hood, or other ventilated enclosure.

Operations that expose toxin solutions to vacuum or pressure should always be handled in this manner, and the operator should also use appropriate respiratory protection to minimize the accidental inhalation of aerosolized toxins or toxin powder. If vacuum lines are used with toxin, they should be protected with a HEPA filter to prevent entry of toxins into the line and include a vacuum flask with decontamination solution between the vacuum source and vacuum line. HEPA filters should be considered to be contaminated with toxin particles and disposed of as described below.

Centrifugation of cultures or materials potentially containing toxins should only be performed using sealed, thick-walled tubes in safety centrifuge cups or sealed rotors. The outside surfaces of containers, safety cups (if applicable), and rotors should be routinely cleaned before and after each use to prevent contamination that may generate an aerosol. The sealed centrifuge safety cups or sealed rotor should be taken from the centrifuge to a BSC prior to opening or it should be taken to other suitable containment prior to breaking the seal and removing centrifugation tubes.

Mechanical Injuries

Accidental needlesticks or mechanical injury from sharps (i.e., glass or metal implements) pose a well-known risk to laboratory workers. When these accidents occur during operations using biological toxins in amounts that approach a human lethal dose, the consequences may be catastrophic. Consequently, additional care must be taken prior to and during toxin operations to reduce the risks of exposure through mechanical injury.

Only workers trained, competent, and experienced in handling animals and toxin operations should be permitted to conduct operations involving animals, especially injection of toxin solutions using hollow-bore needles. Discarded needles/syringes and other sharps should never be recapped; instead, they should be placed directly into properly labeled, puncture-resistant sharps containers and decontaminated. Glassware should be replaced with plastic for handling toxin solutions to minimize the risk of cuts or abrasions from contaminated surfaces. Thin-walled glass equipment should be completely avoided. Glass Pasteur pipettes are particularly dangerous for transferring toxin solutions and should be replaced with disposable plastic pipettes. Glass chromatography columns under pressure must be enclosed within a plastic water jacket or other secondary container.

Additional Precautions

Experiments should be planned to eliminate or minimize work with dry toxin or toxin-containing formulations (e.g., lyophilized material or freeze-dried preparations). Unavoidable operations with dry toxin should only be undertaken with appropriate respiratory protection and engineering controls. Dry toxin can be manipulated using a Class II BSC or with the use of secondary containment such as a disposable glove bag or glove box within a hood. *Static-free disposable gloves* should be worn when working with dry forms of toxins that are subject to spread by electrostatic dispersal. If a Class II BSC is used, HEPA filters should be considered to be contaminated with toxin particles and disposed of as described below. Workers should wear respiratory protection suitable to prevent accidental inhalation of toxin particles.

In specialized laboratories, the intentional, controlled generation of aerosols from toxin solutions may be required to test antidotes or vaccines in experimental animals. These are extremely hazardous operations that should only be conducted after extensive validation of equipment and personnel using non-toxic simulants. Aerosol exposure of animals should be done in a certified Class III BSC or similar containment device. Workers should take additional precautions to avoid accidental exposure to biological toxins when removing exposed animals from the exposure area and for the subsequent 24 hours after exposure; additional precautions include wearing protective clothing (e.g., disposable Tyvek suit) and appropriate respiratory protection. To minimize the risk of dry toxin generating a secondary aerosol, areas of animal skin or fur exposed to aerosols should be gently wiped with a damp cloth containing water or buffered cleaning solution before the animals are returned to holding areas. Injections of toxin solutions into animals can be conducted outside of a BSC, but attention must be paid to avoiding needlesticks and ensuring that used syringes are stored and disposed of properly to avoid accidental contamination or loss of toxin.

For high-risk operations involving dry forms of toxins, intentional aerosol formation, or the use of hollow-bore needles in conjunction with amounts of toxin estimated to be lethal for humans, consideration should be given to requiring the presence of at least two knowledgeable individuals at all times in the laboratory.⁶ This is particularly important when using toxins that have acute effects. While the physicochemical properties of most toxins render interpersonal transmission highly unlikely, emergency care providers should be aware of the possibility of contamination in the environment or through direct transfer of bodily fluids (e.g., during mouth-to-mouth resuscitation). Laboratories using toxins that have acute effects on cardiopulmonary function should have emergency resuscitation training provided and equipment located in the near vicinity to sustain casualties

until the toxic effect passes and emergency caregivers are on-scene. Resuscitation equipment should include mask-bag or oxygen delivery systems to reduce the risk of exposure to emergency caregivers.

Vaccinations against some biological toxins are available and may be appropriate for laboratory workers, depending on the amount of toxin used, frequency of use, and risk of toxin exposure.

Decontamination and Spills

Decontamination of a biological toxin(s) means the toxin is rendered inactive and is no longer capable of exerting its toxic effect. Toxin stability varies considerably outside of physiological conditions depending upon the temperature, pH, ionic strength, presence of co-factors, and other characteristics of the surrounding matrix. Literature values for dry heat inactivation of toxins can be misleading due to variations in experimental conditions, matrix composition, and experimental criteria for assessing toxin activity. Inactivation is not always a linear function of heating time; some protein toxins possess a capacity to re-fold and partially reverse inactivation caused by heating. In addition, the conditions for denaturing toxins in aqueous solutions are not necessarily applicable for inactivating dry, powdered toxin preparations.

General guidelines for laboratory decontamination of selected toxins are summarized in Tables 1 and 2, but inactivation procedures should not be assumed to be 100% effective without validation using specific toxin bioassays. Most toxins are susceptible to steam inactivation (121°C for one hour) or to chemical inactivation with dilute sodium hydroxide (NaOH) at concentrations of 0.1–0.25N, and/or sodium hypochlorite (NaOCl) solutions at concentrations of 0.1–2.5% (w/v). Commercially available bleach solutions typically contain 3–6% (w/v) NaOCl. Bleach decontamination solutions should always be prepared *fresh* (i.e., <24 h).

Contaminated materials and toxin waste solutions can be inactivated by incineration, extensive autoclaving, or by soaking in a suitable decontamination solution, depending on the toxin (Table 2). Once decontaminated, liquid inactivated toxins can be absorbed onto a solid matrix (i.e., absorbent pad, filter paper, or paper towel) for incineration as hazardous waste. Alternatively, liquid inactivated toxins can be disposed of in the sink, depending on local regulations and policies. All disposable contaminated solid material should be placed in secondary containers and then autoclaved and/or disposed of as hazardous waste for incineration. Contaminated or potentially contaminated protective clothing and equipment (e.g., PPE) that is to be re-used should be decontaminated using suitable chemical methods or should be autoclaved after use, if the toxin is heat-labile, and before it is re-used or removed from the laboratory for cleaning or repair.

In the event of a liquid spill, avoid splashes or generating aerosols during clean-up by covering the spill with dry paper towels or other disposable, absorbent material. Ensure that appropriate PPE (at a minimum to include mask, gloves, safety glasses or goggles, and laboratory coat) is worn during the clean-up. Apply an appropriate decontamination solution to the spill, beginning at the perimeter and working towards the center. Allow sufficient contact time for the decontamination solution to completely inactivate the toxin (Table 2). Restrict access to the contaminated area until the decontamination is complete. Absorb the decontaminated toxin onto a solid matrix and discard as hazardous waste for incineration.

Spills involving toxin powder have an increased risk of inhalational exposure. PPE should include respiratory protection, gloves, safety glasses or goggles, and lab coat. If the spill occurs within the BSC, gently cover the powder spill with damp absorbent paper towels to avoid raising dust. Apply the appropriate chemical inactivating agent starting at the perimeter and working toward the center, allowing for sufficient contact time as specified in Table 2. Wipe the area with a paper towel soaked in bleach solution or a decontamination solution specific to the biological toxin; then, wash with soap and water. Dispose of the decontaminated physical waste by autoclaving or as hazardous waste for incineration. A powder spill outside the BSC should trigger the immediate evacuation of the area. The spill should be managed and decontaminated as above; however, access to the contaminated area should be carefully controlled in order to minimize the possibility of disturbing the powder and causing an inhalational exposure. Decontamination personnel should be equipped with respirators. Depending on the size of the spill, the area may have to be quarantined and the HVAC system turned off until the entire spill is contained and the area decontaminated. Filters in the HVAC system may need to be removed and discarded by trained personnel.

Decontamination of large areas, buildings, or offices containing sensitive equipment or documents poses special challenges. Large-scale decontamination is not covered explicitly here, but careful extrapolation from the basic principles may inform more extensive clean-up efforts.

Low molecular weight biological toxins tend to be highly stable and resistant to decontamination. Chemical decontamination with NaOCl is currently the most reliable method for inactivation.⁷ Alternative methods have not proven very effective. For example, 1 N sulfuric or hydrochloric acid does not inactivate T-2 mycotoxin and only partially inactivates microcystin-LR, saxitoxin, and brevetoxin (PbTx-2). Tetrodotoxin and palytoxin are inactivated by hydrochloric acid, but only at relatively high molar concentrations. T-2 is not inactivated by exposure to 18% formaldehyde plus methanol (16 hours), 90% freon-113 + 10% acetic

acid, calcium hypochlorite, sodium bisulfate, or mild oxidizing agents. Hydrogen peroxide is ineffective in inactivating T-2 mycotoxin. Hydrogen peroxide does cause some inactivation of saxitoxin and tetrodotoxin but requires a 16-hour contact time in the presence of ultraviolet light. The addition of 3% acetone after bleach treatment has been suggested to prevent reformation of mycotoxins after bleach treatment when decontaminating spills or glassware.⁸

Select Toxins

HHS and the USDA have identified a group of toxins that pose a severe threat to human, animal, and/or plant health as Select Toxins. The Federal Select Agent Program oversees the possession, use, and transfer of these toxins, to include botulinum neurotoxins (all serotypes and subtypes), abrin, paralytic alpha conotoxins, diacetoxyscirpenol, ricin, saxitoxin, staphylococcal enterotoxins (subtypes A–E), T-2 toxin, and tetrodotoxin. A current list of Select Toxins and exempt quantities can be found at <https://www.selectagents.gov/SelectAgentsandToxins.html>. Registration with the CDC or USDA is required for possession, use, modification, production, storage, and/or transfer of non-exempt quantities of Select Toxins, while exempt quantities should be carefully managed by the responsible organization to prevent loss or misuse. Most Select Toxins are highly potent, and corresponding antidotes are not clinically available; thus, extreme care must be taken when using these agents for clinical or research purposes. Risk assessments and emergency treatment plans should be formulated that are specific to the dangers of each Select Toxin, and responsible parties should undertake regular reviews of laboratory procedures to ensure that laboratory procedures are understood and carefully followed by technical personnel.

Table 1. Physical Inactivation of Toxins

Toxin	Steam Autoclave	Dry Heat (10 min)	Freeze-Thaw	Gamma Irradiation
Botulinum neurotoxin A–G	Yes ^a	≥ 100° C ^b	No ^c	Incomplete ^d
Staphylococcal enterotoxin	Yes ^e	≥ 100° C; refold ^f	No ^g	Incomplete ^h
Ricin	Yes ⁱ	≥ 100° C ⁱ	No ^j	Incomplete ^k
Microcystin	No ^l	≥ 260° C ^m	No ⁿ	ND
Saxitoxin	No ^l	≥ 260° C ^m	No ⁿ	ND
Palytoxin	No ^l	≥ 260° C ^m	No ⁿ	ND

Continued on next page ►

Toxin	Steam Autoclave	Dry Heat (10 min)	Freeze-Thaw	Gamma Irradiation
Tetrodotoxin	No ^l	≥ 260° C ^m	No ⁿ	ND
T-2 mycotoxin	No ^l	≥ 815° C ^m	No ⁿ	ND
Brevetoxin (PbTx-2)	No ^l	≥ 815° C ^m	No ⁿ	ND
Abrin	Yes ^o	ND	ND	ND
Shiga toxin	Yes ^p	ND	ND	ND

ND indicates “not determined” from available literature.

- a. Steam autoclaving should be at ≥121° C for 1 h For volumes larger than 1 liter, especially those containing *Clostridium botulinum* spores, autoclave at ≥121° C for 2 h to ensure that sufficient heat has penetrated to kill all spores. ^{9,10}
- b. Exposure to 100° C for 10 min inactivates BoNT. Heat denaturation of BoNT as a function of time is biphasic with most of the activity destroyed relatively rapidly, but with some residual toxin (e.g., 1–5%) inactivated much more slowly. ¹¹
- c. Measured using BoNT serotype A at -20° C in food matrices at pH 4.1–6.2 over a period of 180 days. ¹²
- d. Measured using BoNT serotypes A and B with gamma irradiation from a ⁶⁰Co source. ^{13,14}
- e. Protracted steam autoclaving, similar to that described for BoNT, followed by incineration is recommended for disposal of SE-contaminated materials.
- f. Inactivation may not be complete depending upon the extent of toxin re-folding after denaturation. Biological activity of SE can be retained despite heat and pressure treatment routinely used in canned food product processing. ¹⁵
- g. SE toxins are resistant to degradation from freezing, chilling or storage at ambient temperature. Active SEB in the freeze-dried state can be stored for years. ¹⁶
- h. References ^{16,17}
- i. Dry heat of >100° C for 60 min in an ashing oven or steam autoclave treatment at >121° C for 1 h reduced the activity of pure ricin by >99%. ⁷ Heat inactivation of impure toxin preparations (e.g., crude ricin plant extracts) may vary. Heat-denatured ricin can undergo limited refolding (<1%) to yield active toxin.
- j. Ricin holotoxin is not inactivated significantly by freezing, chilling, or storage at ambient temperature. In the liquid state with a preservative (sodium azide), ricin can be stored at 4° C for years with little loss in potency.
- k. Irradiation causes a dose-dependent loss of activity for aqueous solutions of ricin, but complete inactivation is difficult to achieve; 75 MRad reduced activity 90%, but complete inactivation was not achieved even at 100 MRad. ¹⁸ Gamma irradiation from a laboratory ⁶⁰Co source can be used to partially inactivate aqueous solutions of ricin, but dried ricin powders are significantly resistant to inactivation by this method.
- l. Autoclaving with 17 lb pressure (123° C) for 30 min failed to inactivate LMW toxins. ^{7,19} All burnable waste from LMW toxins should be incinerated at temperatures in excess of 815° C (1,500° F).
- m. Toxin solutions were dried at 150° C in a crucible, placed in an ashing oven at various temperatures for either 10 or 30 min, reconstituted, and tested for concentration and/or activity; tabulated values are temperatures exceeding those required to achieve 99% toxin inactivation. ⁷
- n. LMW toxins are generally very resistant to temperature fluctuations and can be stored in the freeze-dried state for years and retain toxicity.
- o. Reference ²⁰
- p. Reference ^{21,22}

Table 2. Chemical Inactivation of Toxins

Toxin	NaOCl (30 min)	NaOH	Freeze-Thaw	Gamma Irradiation
Botulinum neurotoxin A–G	≥ 0.1% ^a	≥ 0.25 N	ND	Yes ^b
Staphylococcal enterotoxin	≥ 0.5% ^c	≥ 0.25 N	ND	ND
Ricin	≥ 1.0% ^d	ND	> 0.1% + 0.25 N ^e	ND
Saxitoxin	≥ 0.1% ^e	ND	0.25% + 0.25 N ^e	ND
Palytoxin	≥ 0.1% ^e	ND	0.25% + 0.25 N ^e	ND
Microcystin	≥ 0.5% ^e	ND	0.25% + 0.25 N ^e	ND
Tetrodotoxin	≥ 0.5% ^e	ND	0.25% + 0.25 N ^e	ND
T-2 mycotoxin	≥ 2.5% ^{e,f}	ND	0.25% + 0.25 N ^e	ND
Brevetoxin (PbTx-2)	≥ 2.5% ^{e,f}	ND	0.25% + 0.25 N ^e	ND
Alpha conotoxins	≥ 0.5% ^g	10 N ^g	ND	No ^g
Abrin	≥ 0.7% ^h	ND	ND	ND
Shiga toxin	≥ 0.5%	ND	0.25% + 0.25 N ^e	ND

ND indicates “not determined” from available literature.

- Solutions of NaOCl (≥ 0.1% final concentration; typically a 1:50 dilution of commercial bleach into distilled water) or NaOH (> 0.25 N) for 30 min inactivate BoNT and are recommended for decontaminating work surfaces and spills of *C. botulinum* or BoNT. Chlorine at a concentration of 0.3–0.5 mg/L as a solution of hypochlorite rapidly inactivates BoNT (serotypes B or E tested) in water.²³ Chlorine dioxide inactivates BoNT, but chloramine is less effective.^{23,24} After decontamination, the solution is safe to discard in the sink as long as local ordinances are obeyed. Alternatively, BoNT can be absorbed onto a disposable napkin, dried, and disposed of in hazardous waste for incineration.
- Ozone (> 2 mg/L) or powdered activated charcoal treatment also completely inactivate BoNT (serotypes A, B tested) in water under defined conditions.^{24,25}
- SEB is inactivated with 0.5% hypochlorite for 10–15 min.²⁶
- Ricin is inactivated by a 30-min exposure to concentrations of NaOCl ranging from 0.1–2.5%, or by a mixture of 0.25% NaOCl plus 0.25 N NaOH.⁷ In general, solutions of 1.0% NaOCl are effective for decontamination of ricin from laboratory surfaces, equipment, animal cages, or small spills.
- The minimal effective concentration of NaOCl was dependent on toxin and contact time; all LMW toxins tested were inactivated at least 99% by treatment with 2.5% NaOCl, or with a combination of 0.25% NaOCl and 0.25 N NaOH.⁷
- For T-2 mycotoxin and brevetoxin, liquid samples, accidental spills, and nonburnable waste should be soaked in 2.5% NaOCl with 0.25 N NaOH for 4 h. Cages and bedding from animals exposed to T-2 mycotoxin or brevetoxin should be treated with 2.5% NaOCl and 0.25 N NaOH for 4 h. Exposure for 30 min to 1.0% NaOCl is an effective procedure for the laboratory (working solutions, equipment, animal cages, working area and spills) for the inactivation of saxitoxin or tetrodotoxin. Decontamination of equipment and waste contaminated with select brevetoxins has been reviewed.¹⁹
- Conotoxins can also be inactivated using reducing agents such as dithiothreitol β- mercaptoethanol, or tris (2-carboxyethyl) phosphine (100 mM) at 65–100° C for 15 min, followed by alkylation with 100 mM maleimide in isopropanol at 65° C for 15 min. Alternatively, alpha conotoxins can be inactivated by hydrolysis in 10 N NaOH or HCl at 100° C for 30 min.²⁷
- Exposure of crude abrin solution and dried abrin to 0.67% NaOCl eliminated over 90% of cytotoxicity within 5 min.²⁸

References

1. Franz DR. Defense Against Toxin Weapons. In: Sidell FR, Takafuji ET, Franz DR, editors. *Medical Aspects of Chemical and Biological Warfare. The TMM Series. Part 1: Warfare, Weaponry, and the Casualty.* Washington (DC): Office of the Surgeon General at TMM Publications; 1997. p. 603–19.
2. Millard CB. Biological weapons defense: infectious diseases and counterbioterrorism. Lindler LE, Lebeda FJ, Korch GW, editors. Totowa (NJ): Humana Press. 2005. Medical defense against protein toxin weapons: review and perspective; p. 255–84.
3. The biological defense safety program—technical safety requirements, 32 C.F.R. Part 627 (1993).
4. Johnson B, Mastnjak R, Resnick IG. Anthology of Biosafety II: Facility Design Considerations. Richmond J, editor. Mundelein (IL): American Biological Safety Association; 2000. Vol 2. Safety and Health Considerations for Conducting Work with Biological Toxins; p. 88–111.
5. Kruse RH, Puckett WH, Richardson JH. Biological safety cabinetry. *Clin Microbiol Rev.* 1991;4:207–41.
6. Kozlovac J, Hawley RJ. Biological toxins: safety and science. In: Wooley DP, Byers KB, editors. *Biological safety: principles and practice.* Washington (DC): ASM Press; 2017. p. 247–68.
7. Wannemacher RW, Bunner DL, Dinterman RE. Inactivation of low molecular weight agents of biological origin. In: US Army Chemical Research, Development & Engineering Center. *Proceedings for the Symposium on Agents of Biological Origins; 1989 Mar 21–23; Laurel (MD).* p. 115–22.
8. U.S. Food & Drug Administration. ORA Laboratory Manual. [Internet]. 2013 [cited 2018 Sept 28]; IV(7): [about 23 p.]. Available from: <https://www.fda.gov/ScienceResearch/FieldScience/LaboratoryManual/default.htm>
9. Balows A, Hausler WJ Jr, Ohashi M, Turano A, editors. *Laboratory Diagnosis of Infectious Diseases: Principles and Practice. Vol 1.* New York: Springer-Verlag; 1988.
10. Hatheway CL. Botulism. In: Balows A, Hausler WJ Jr, Ohashi M, Turano A, editors. *Laboratory Diagnosis of Infectious Diseases: Principles and Practice. Vol 1.* New York: Springer-Verlag; 1988. p. 111–33.
11. Siegel LS. Destruction of botulinum toxins in food and water. In: Hauschild AHW, Dodds KL, editors. *Clostridium botulinum: Ecology and Control in Foods.* New York: Marcel Dekker, Inc.; 1993. p. 323–41.
12. Woolford A, Schantz EJ, Woodburn M. Heat inactivation of botulinum toxin type A in some convenience foods after frozen storage. *J Food Sci.* 1978;43:622–4.

13. Dack GM. Effect of irradiation on *Clostridium botulinum* toxin subjected to ultracentrifugation. Natick (MA): Quartermaster Food and Container Institute for the Armed Forces; 1956. Report No.: 7.
14. Wagenaar RO, Dack GM. Effect in surface ripened cheese of irradiation on spores and toxin of *Clostridium botulinum* types A and B. Food Research Institute. 1956;21:226–34.
15. Bennett RW, Berry MR. Serological reactivity and in vivo toxicity of *Staphylococcus aureus* enterotoxin A and D in selected canned foods. J Food Sci. 1987;52:416–8.
16. Concon JM. Bacterial Food Contaminants: Bacterial Toxins. In: Concon JM, author. Food Toxicology (in two parts) Parts A and B. New York: Marcel Dekker, Inc.; 1988. p. 771–841.
17. Modi NK, Rose SA, Tranter HS. The effects of irradiation and temperature on the immunological activity of staphylococcal enterotoxin A. Int J Food Microbiol. 1990;11:85–92.
18. Haigler HT, Woodbury DJ, Kempner ES. Radiation inactivation of ricin occurs with transfer of destructive energy across a disulfide bridge. Proc Natl Acad Sci USA. 1985;82(16):5357–9.
19. Poli MA. Laboratory procedures for detoxification of equipment and waste contaminated with brevetoxins PbTx-2 and PbTx-3. J Assoc Off Anal Chem. 1988;71(5):1000–2.
20. Tam CC, Henderson TD, Stanker LH, He X, Cheng LW. Abrin Toxicity and Bioavailability after Temperature and pH Treatment. Toxins. 2017;9(10):320.
21. Rasooly R, Do PM. Shiga toxin Stx2 is heat-stable and not inactivated by pasteurization. Int J Food Microbiol. 2010;136(3):290–4.
22. Lumor SE, Fredrickson NR, Ronningen I, Deen BD, Smith K, Diez-Gonzalez F, et al. Comparison of the presence of Shiga toxin 1 in food matrices as determined by an enzyme-linked immunosorbent assay and a biological activity assay. J Food Prot. 2012;75(6):1036–42.
23. Notermans S, Havelaar AH. Removal and inactivation of botulinum toxins during production of drinking water from surface water. Antonie Van Leeuwenhoek. 1980;46:511–4.
24. Brazis AR, Bryant AR, Leslie JE, Woodward RL, Kabler PW. Effectiveness of halogens or halogen compounds in detoxifying *Clostridium botulinum* toxins. J Am Waterworks Assoc. 1959;51(7):902–12.
25. Graikoski JT, Blogoslowski WJ, Choromanski J. Ozone inactivation of botulinum type E toxin. Ozone: Sci Eng. 1985;6:229–34.
26. Robinson, JP. Annex 2—Toxins. In: Public Health Response to Biological and Chemical Weapons: WHO Guidance. 2nd ed. Geneva (Switzerland): World Health Organization; 2004. p. 214–28.

27. Liu D, editor. *Manual of Security Sensitive Microbes and Toxins*. 1st ed. Boca Raton (FL): CRC Press, Taylor & Francis Group; 2014.
28. Tolleson WH, Jackson LS, Triplett OA, Aluri B, Cappozzo J, Banaszewski K, et al. Chemical inactivation of protein toxins on food contact surfaces. *J Agric Food Chem*. 2012;60(26):6627–40.

Appendix J—NIH Oversight of Research Involving Recombinant Biosafety Issues

The locus for oversight of research subject to the *NIH Guidelines for Research Involving Recombinant or Synthetic Nucleic Acid Molecules (NIH Guidelines)* within NIH is the Office of Science Policy (OSP), which is located within the Office of the Director of the NIH, and is responsible for the oversight of research involving recombinant or synthetic nucleic acid molecules. The key elements in the biosafety oversight framework for such research are the *NIH Guidelines* and Institutional Biosafety Committees (IBCs) or equivalent resource. NIH OSP promotes the science, safety, and ethics of research subject to the *NIH Guidelines* with the primary goals of enabling the safe conduct of research and of helping to advance all fields of science that employ recombinant or synthetic nucleic acid molecules.

The *NIH Guidelines* specify appropriate biosafety practices and procedures for research involving the construction and handling of recombinant or synthetic nucleic acid molecules, as well as cells, organisms, and viruses that contain such molecules. Recombinant or synthetic nucleic acid molecules are defined in the *NIH Guidelines* as:

1. Molecules that a) are constructed by joining nucleic acid molecules and b) that can replicate in a living cell (i.e., recombinant nucleic acids);
2. Nucleic acid molecules that are chemically, or by other means, synthesized or amplified, including those that are chemically or otherwise modified but can base pair with naturally occurring nucleic acid molecules (i.e., synthetic nucleic acids); or
3. Molecules that result from the replication of those described in (1) or (2).

Compliance with the *NIH Guidelines* is a term and condition of NIH funding, and the *NIH Guidelines* are applicable to all research conducted at or sponsored by an institution that receives any funding from the NIH for recombinant or synthetic nucleic acid molecule research, regardless of the funding source of an individual project. The broad reach of the *NIH Guidelines* promotes the consistency of biosafety practices across the institution to better protect the safety of laboratory workers, the public, and the environment.

The *NIH Guidelines* were first published in 1976 and are revised as technological, scientific, and policy developments warrant. They outline the roles and responsibilities of various entities involved in the conduct or oversight of recombinant or synthetic nucleic acid molecule research, including institutions, investigators, IBCs, biosafety officers, and the NIH (Section IV of the *NIH Guidelines*). They classify agents into one of four Risk Groups (Appendix B of the *NIH Guidelines*) based on their potential to cause disease in a healthy adult human and describe four levels of physical containment practices (Appendix G of the *NIH Guidelines*)

that should be employed for research with the agents based on the potential risk. The *NIH Guidelines* establish different levels of review and approval for recombinant or synthetic nucleic acid molecule research, based on the nature of the activity. These levels are:

1. Approval from the NIH Director and the IBC before initiation of the research.
2. Approval from NIH OSP and the IBC before initiation of the research.
3. Approval from the IBC before initiation of human gene transfer research.
4. Approval from the IBC prior to initiation of the research.
5. Notification of the IBC simultaneous with initiation of the research with subsequent IBC review and approval.

See Section III of the *NIH Guidelines* for additional details. In all instances, it is important to note that review and approval by an IBC is required.

The roles and responsibilities of IBCs, as well as membership, procedures, and functions are outlined in Section IV-B-2 of the *NIH Guidelines*. Institutions that are ultimately responsible for the effectiveness of IBCs may define additional roles and responsibilities for these committees in addition to those specified in the *NIH Guidelines*. For example, some institutions may set a policy that their IBC will also review certain research that is not subject to the *NIH Guidelines* (e.g., research involving non-recombinant pathogens). The *NIH Guidelines* are available at <https://osp.od.nih.gov/biotechnology/nih-guidelines/>.

Additional information regarding NIH OSP, the *NIH Guidelines*, and the roles and responsibilities of IBCs can be found at <http://osp.od.nih.gov>.

Appendix K—Inactivation and Verification

This appendix describes inactivation methods that enable retention of characteristic(s) of interest in pathogens, viral nucleic acid sequences, or toxins in order to accommodate the intended future use(s) of the material and verification of inactivation procedures. Inactivation and verification of Select Agents and Toxins must be in compliance with current regulations from the Federal Select Agent Program.¹

Key Terminology discussed in this appendix is defined in the Glossary and includes inactivation, validated inactivation procedure, viability testing protocol, infectivity testing, toxicity testing, attenuation, process verification, institutional verification, and validation.¹

Background

When choosing an inactivation method, consider key characteristics, including the infectious agent (e.g., pathogen, viral nucleic acid sequences, or toxin), resistance to treatment, and ability to recover from the treatment.^{2,3} Environmental stability is high for some agents including spores, pathogens residing within biofilms, and prions.

Different types of inactivation procedures target different components and/or systems within the agent. Inactivation targets include: bacterial cell walls; lipid envelopes or cell membranes; nucleic acids; and regulatory systems involved in the agent's virulence, replication, and/or transmissibility. Types of inactivation methods may include:

- Physical (e.g., heat,^{4,5} ionizing irradiation,^{6,7} 254 nm ultraviolet [UV] light^{8–10});
- Chemical (e.g., chaotropic compounds such as guanidine hydrochloride,^{11–14} oxidizers such as chlorine and hydrogen peroxide,^{15–18} psoralen or titanium dioxide nanoparticles activated by UV-A^{10,19–23});
- Natural antimicrobial strategies (e.g., enzymes such as lysozymes and virolysins [bacteriophage-encoded lytic enzymes^{24–26}], antimicrobial peptides such as nisin,²⁷ and bacteriophages²⁸); or
- Combination (e.g., sublethal mild temperatures [<60 degrees Celsius] with various nonthermal treatments,² antimicrobial compounds with ionizing radiation,²⁹ and lysozyme with antimicrobial compounds³⁰).

Some traditional disinfection methods can also serve as inactivation treatments. For example, spores, vegetative bacteria, DNA viruses, and RNA viruses can be effectively inactivated with peracetic acid with minimal effects on the ability to do subsequent PCR and ELISA immunoassays.¹⁸ Alternatives to antibiotics for humans and animals, environmental decontamination methods, and food safety processes could potentially lead to the development of inactivation procedures.²⁵

Novel inactivation strategies include use of cell wall hydrolases, such as lysozyme,²⁴ and antimicrobial peptides such as nisin.²⁷

When choosing an inactivation method, several factors need to be considered including: specific controls; the balance between efficacy of inactivation vs. the retention of desired characteristics; and the appropriate safety margin (i.e., overkill amount). Additional advantages may include low cost and broad applicability to different types of agents.

Filtration and Centrifugation

Filtration is a common pathogen removal method; filtration is also used to supplement an inactivation method by removing or reducing the amount of active pathogen, viral nucleic acid sequences, or toxin from biological fluids, culture supernatant, and other materials. Filtration may result in the loss of a significant fraction of the material to be used and will require viability testing to ensure no agent passes through any defect in the filter. Centrifugation or centrifugation combined with filtration can be used to supplement inactivation methods by separating out and removing significant amounts of the pathogen, viral nucleic acid sequences, or toxin from the material that will be used for subsequent purposes. Centrifugation may result in adverse effects on the structural integrity of the residual material and requires additional time and processing steps to recover the material for further use.

An extract (e.g., nucleic acids, antigens, lysate) is derived from a two-step process with an initial step (e.g., lysis) where the agent is subjected to a treatment, followed by a second step (e.g., filtration) to remove any residual active agent.

Development of Inactivation Procedures

The starting point for development of an inactivation procedure is deciding which inactivation method(s) is appropriate, effective, and feasible to use for the specific set of circumstances. Inactivation procedures considered can be based on:

1. A procedure developed in-house;
2. A procedure published in a peer-reviewed journal; or
3. A commonly accepted method (e.g., heat, dry or wet).

Many variables need to be considered when developing inactivation procedures; these include the type and amount (i.e., volume and titer) of agent (e.g., pathogen, nucleic acid or toxin) to be inactivated; matrix/solvent surrounding the agent; concentration of starting matrix material; treatment time, temperature, pH, and dose of treatment; process controls; type of container being used for inactivation; and appropriate safety measures. The post-exposure environment may also play a role in the efficacy of the inactivation; therefore, the subsequent environmental conditions (e.g., temperature and nutrients in the matrix) should be controlled as well.

In cases where limited samples are available, it may be appropriate to use surrogate strains or agents to develop the inactivation procedures. If resistance information is known, the most resistant strain or agent should be used as the surrogate. Generally, suitable surrogates are bacteria from the same genus and viruses from the same family. Another type of surrogate that may be appropriate in some situations is a tissue surrogate. In this case, a sample of the tissue adjacent to the tissue of interest that has also undergone the inactivation may be used for confirmation of the inactivation procedure and verification that adequate efficacy has been achieved in the process.

Use of dose-response (e.g., survival of the pathogen, viral nucleic acids, or toxin vs. the inactivating treatment dose or time), spike-and-recovery experiments (i.e., bioburden reduction studies), and building an adequate safety margin are all important elements to incorporate into an inactivation procedure. Factors that should be considered include:

1. Testing method(s) for the specific set of circumstances involved (e.g., type, amount, and concentration of starting material);
2. Controls (process, negative, positive);
3. The limit of detection;
4. Interference of residual inactivation material and matrix materials with viability, infectivity, or toxicity testing; and
5. Appropriate safety margins.

Tables 1–8 outline the key advantages and disadvantages of four broad inactivation method categories—physical, chemical, chemical activated by physical, and natural and emerging. Tables 9 and 10 outline advantages and disadvantages of combination methods.

Physical inactivation includes heat (dry or wet),^{4,5} ionizing radiation,^{6,7} and ultraviolet light (UV-C radiation).^{8–10} Physical inactivation through heat involves hot-air (dry) or steam under pressure (wet), which is used to irreversibly destroy an agent's protein structure (denaturation). Ionizing radiation induces single- and double-strand breaks in nucleic acids. Ultraviolet light, especially at 254 nm, is an effective treatment for reduction of bacteria; UV-C causes photochemical damage to nucleic acids through formation of pyrimidine dimers, inhibiting DNA replication and transcription.

Table 1. Advantages of Physical Inactivation

Consideration	Heat	Ionizing radiation	Light (UV-C)
Efficacy	Broad	Broad	Inactivates viruses, Gram-positive and Gram-negative bacteria
Applicability	Broad	Broad	Broad
Residual toxicity	Low	None	None
Cost	N/A	N/A	Low cost
Structural maintenance	N/A	Proteins; 3-D structure preserved	Most proteins
Penetration	Complete, depending on length of treatment	Inactivation of denser materials	Surface
Resistance	N/A	None observed	None observed
Ease of use	Simple and convenient	N/A	Short exposure time

Table 2. Disadvantages of physical inactivation

Consideration	Heat	Ionizing radiation	Light (UV-C)
Acute Toxicity	Thermal burns possible	High toxicity	May damage exposed skin
Structural maintenance	Limited due to denaturation of proteins; may damage agent's ability to produce immune response	N/A	DNA intrastrand crosslinks limit use for PCR and transcription assays
Cost	N/A	High cost	N/A
Penetration	Limited by access of all material to steam or dry heat; trapped air may serve as insulation	N/A	Limited by capacity of light; impacted by opaqueness of liquid, proportion of suspended particles, soluble and insoluble materials, and distance from UV source
Ease of use	N/A	Regulatory, security constraints (irradiator); long exposure times	N/A

Chemical inactivation includes chaotropic agents^{11–14} and oxidizers.^{15–18} Chemical inactivation through chaotropic agents utilizes guanidine-based denaturing agents to disrupt cells and liberate nucleic acids; these agents have strong protein denaturant properties when used at high concentrations. Oxidizing agents oxidize cell membranes resulting in loss of structure leading to cell lysis and death. Examples of oxidizing agents include: hypochlorous acid (HOCl), chlorine, hydrogen peroxide, and peracetic acid.

Table 3. Advantages of chemical inactivation

Consideration	Chaotropic agents	Oxidizers
Efficacy	Inactivates viruses, Gram-positive and Gram-negative bacteria	Broad; HOCl effective against prions and spore-forming <i>Bacillus</i> spp., with rapid inactivation
Applicability	N/A	Broad
Residual toxicity	N/A	Low toxicity (weak acids safe for contact with skin, mucous membranes)
Cost	N/A	Low cost
Structural maintenance	Nucleic acids preserved	N/A
Ease of use	Non-volatile; effective at room temperature; kits with prepared reagents are available	N/A

Table 4. Disadvantages of chemical inactivation

Consideration	Chaotropic agents	Oxidizers
Efficacy	Incomplete inactivation of spores	N/A
Acute toxicity	Irritant, toxic, corrosive at high concentrations	Irritant, toxic, corrosive at high concentrations
Structural maintenance	N/A	May damage agent's ability to produce an immune response
Ease of use	Need to be removed or neutralized to assess inactivation	Limited storage stability; may need to be neutralized to assess inactivation

Inactivation may also be achieved via a chemical inactivation activated by physical treatment; examples include psoralen and UV-A radiation^{19–21} and titanium dioxide (TiO₂) and UV-A radiation.^{10,22,23} Psoralens, in the presence of

UV-A (320–400 nm) radiation, inactivate viral agents. TiO₂ is a stable and inert material that can continuously exhibit antimicrobial effects when illuminated. Photocatalysis increases cell permeability with efflux of intracellular contents leading to cell death.

Table 5. Advantages of chemical activated by physical treatment

Consideration	Psoralen + UV-A	TiO ₂ + UV-A
Efficacy	Affects a wide range of viruses	Wide range of agents, including lethal toxin of <i>Bacillus anthracis</i> ; Nanoparticles (titania) exhibit superior inactivation
Structural maintenance	Viral surface epitopes and nucleic acids preserved	N/A
Resistance	None observed	N/A
Ease of use	N/A	Chemically stable; energy source can be solar light

Table 6. Disadvantages of chemical activated by physical treatment

Consideration	Psoralen + UV-A	TiO ₂ + UV-A
Efficacy	Limited to viruses	Efficiency of technology needs improvement
Structural maintenance	N/A	Characteristics may be affected by cell wall damage
Ease of use	Amotosalen (AMT) needs to be removed or neutralized to assess efficacy of inactivation	Requires close contact between agent and TiO ₂

Inactivation may also be achieved through natural and emerging antimicrobial strategies including lysozyme,^{24–26} antimicrobial peptides (AMP),^{25,27} and bacteriophages.^{25,28} Bacterial killing by lysozyme occurs through hydrolysis of cell walls. It is effective against Gram-positive bacteria and is an important component in the prevention of microbial growth in foods. Bacteriocins (i.e., bacterial proteins or peptides) are AMPs widely used in food bio-preservation. Antimicrobial peptides are the cornerstone of innate immunity. AMPs have various intracellular and extracellular targets, but AMPs primarily bind to and form pores in cell membranes. Bacteriophages (phages) are viruses capable of infecting and killing bacteria. Phages are among the most abundant organisms in nature and are not known to infect eukaryotes. Use of multiple closely related phages (i.e., cocktail) has been shown to be more effective in killing microbial pathogens.

Table 7. Advantages of natural and emerging antimicrobial strategies

Consideration	Lysozyme	AMPs	Bacteriophages
Applicability	Broad	Broad	N/A
Efficacy	Broad; effective against Gram-positive bacteria (acts to kill bacteria immediately); food and waterborne viruses	Broad; wide spectrum of agents, particularly bacteria; non-immunogenic	Highly active with targeted, specific host range; particularly effective against several foodborne pathogens
Residual toxicity	Low toxicity	Low toxicity	Low toxicity
Cost	Low cost	N/A	Low cost
Recoverability	N/A	Low; AMPs with extracellular and intracellular targets provide a multi-pronged attack (lessening possibility of recovery)	Low; cocktail of related phages increases efficacy and limits recoverability
Ease of use	Lysozyme is generally heat stable and effective at low concentrations (~1%)	N/A	N/A

Table 8. Disadvantages of natural and emerging antimicrobial strategies

Consideration	Lysozyme	AMPs	Bacteriophages
Applicability	Not as effective on Gram-negative bacteria due to their complex cell wall composition	N/A	Narrow host range
Efficacy	N/A	N/A	Bacterial resistance to phages may lead to development of bacteriophage insensitive mutants; efficacy may be temperature-dependent
Structural maintenance	Potential for destruction of pathogen's cell wall may limit use of inactivated materials	Potential for destruction of pathogen's cell wall may limit use of inactivated materials; key intracellular structural proteins of pathogen important for use may be affected	Lysis by phage may limit recovery of cellular materials

Continued on next page ►

Consideration	Lysozyme	AMPs	Bacteriophages
Off-target effects	N/A	N/A	Phage-mediated transfer of genetic material to hosts; need for careful monitoring to ensure phage genome is free from toxin and virulence genes
Ease of use	Low stability (short half-life)	Low stability (AMPs inactivated by proteases)	N/A
Ease of use	Lysozyme is generally heat stable and effective at low concentrations (~1%)	N/A	N/A

Finally, inactivation may be achieved through combination methods including sub-lethal mild temperatures (<60°C) with non-thermal treatments,² antimicrobial compounds with ionizing radiation,²⁹ and antimicrobial compounds with lysozyme.³⁰ Some common non-thermal treatments include High Pressure Processing (HPP), Pulsed Electric Field (PEF), and ultrasound (US). The use of anti-microbial compounds, such as AMPs, can facilitate reduction of the dose of ionizing radiation treatment necessary for inactivation of pathogens. Synergistic effects of antimicrobial compounds, such as AMPs with lysozyme, effectively inactivate and/or kill Gram-positive bacteria. Antimicrobial compounds with lysozyme are effective against a broader spectrum of pathogens. Resistance mechanisms to antimicrobial compounds are well known and must be considered as a potential risk.³¹

Table 9. Advantages of combination methods

Consideration	Temperature + non-thermal	Antimicrobial + ionizing radiation	Antimicrobial + lysozyme
Applicability	Broad	Broad	Combination treatment results in higher efficacy for a broader spectrum of pathogens, including germinating spores
Efficacy	Broad; effective on a wide variety of agents; efficacy greatly enhanced by combined use of sub-lethal mild temperatures with non-thermal treatments	Broad; effective inactivation of agents including a wide variety of foodborne pathogenic bacteria	Effective inactivation of bacteria, particularly Gram-positive bacteria, and a wide variety of foodborne pathogenic bacteria

Continued on next page ►

Consideration	Temperature + non-thermal	Antimicrobial + ionizing radiation	Antimicrobial + lysozyme
Residual toxicity	Low Toxicity	Lowered by combination treatment since lower dose of ionizing radiation is effective	Low Toxicity
Structural maintenance	N/A	Lower dose of ionizing irradiation is key to retention of desirable qualities of animal and plant products.	N/A
Ease of use	Combination allows shorter processing times	N/A	N/A

Table 10. Disadvantages of combination methods

Consideration	Temperature + non-thermal	Antimicrobial + ionizing radiation	Antimicrobial + lysozyme
Applicability	Non-thermal techniques are less effective against spores	N/A	Generally ineffective against Gram-negative bacteria
Cost	N/A	High cost for some natural antimicrobial compounds	N/A
Recoverability	Not all pathogens present are inactivated at same time; potential for sublethal injury and possibility of recovery	N/A	N/A
Off-target effects	N/A	Need to consider broad-spectrum of effects by antimicrobials, including synthetic ones, on host	Need to consider broad-spectrum of effects by antimicrobials, including synthetic ones, on host
Resistance	N/A	Resistance to antimicrobial peptides await more in-depth investigation	Resistance to antimicrobial peptides await more in-depth investigation
Ease of use	Optimization of combination technologies to obtain highest efficacy needed	Low stability (some natural antimicrobial compounds have finite half-life)	Inactivation is not immediate

Validation of Inactivation Procedures

Conditions of an inactivation procedure must be optimized for efficacy and tailored to the specific materials and circumstances present in that setting. A validated inactivation procedure will designate a set of conditions that have been determined to adequately render:

1. A pathogen non-viable, with efficacy established by viability testing data;
2. The isolated viral nucleic acid incapable of producing infectious forms of virus, with efficacy established by infectivity testing data; or
3. A toxin no longer capable of exerting a toxic effect, with efficacy established by toxicity testing data.

Viability testing procedures may include cell viability assays, growth analysis, in vivo exposure, or a combination of these methods. A common viral infectivity testing procedure consists of introducing the positive (+) strand RNA into permissive cells to determine if that strand can produce an infectious virus. Toxicity testing may include functional activity assays and in vivo exposure assays.

The potential for incomplete inactivation, including errors that might result from exceeding the capacity of the inactivating process to kill the pathogen, lack of specificity, detection limits, and run-to-run variation should be considered when setting specifications for confirmed inactivation procedures. Sufficient replicates of the testing must be performed in order to determine the underlying variability within the procedure in the hands of the laboratorians performing it. In addition to the factors considered during development of an inactivation procedure, elements that should be evaluated when confirming an inactivation procedure include:

1. Any chemical inactivation treatments that need to be neutralized or diluted prior to the confirmation testing; and
2. The statistical probability of inactivation (i.e., was the sample subject to sufficient inactivating material/process to provide a statistically significant probability of complete inactivation).

Alternative Strategies

Alternative strategies, such as sampling and use of surrogates, may be considered when standard validation of an inactivation procedure is not a viable option. Sampling of a subset of inactivated material may be the strategy of choice for situations where materials are limited or when other conditions make full confirmation impractical. Depending on the type of inactivated material, sampling could involve either testing a subset of the total number of samples that are similar or testing a fraction of each of the samples.

The level of underlying variability is a key determinant of the level of confirmation that should be done; factors to consider include the frequency of testing, the

appropriate sampling strategy, the use of surrogates, and the percentage of the sample(s) tested. The underlying variability depends on multiple factors including the type of sample, the type of inactivation procedure, and the specific materials, equipment, and conditions used in the inactivation procedure. Laboratories should re-confirm inactivation procedures whenever changes (e.g., in reagents, equipment, or environmental conditions) are introduced into the existing validated inactivation methods. Inactivation procedures should also be re-assessed and re-validated periodically due to the agent itself changing over time, either through natural or deliberate means (e.g., mutation, recombination, reassortment of viral genomes, horizontal gene transfer, synthetic derivation of agents, and modifications resulting from gain-of-function studies).

The risk assessment is the basis for the institution setting a policy on a sampling strategy that it considers sufficient for future runs of the inactivation procedure. It may be appropriate for inactivation procedures with lower risk materials or ones that have minimal underlying variability to test only the process controls in subsequent inactivation runs while it may be appropriate to do confirmation for all subsequent inactivated samples for those inactivation procedures with higher risk materials and/or those that have greater underlying variability.

More stringent viability testing is warranted for materials that have only undergone agent removal (e.g., filtration) than for those materials that have been treated with both an inactivation method and a removal step to filter out any residual active agent. The risk for not doing infectivity testing for every viral nucleic acid extract is mitigated by confirmation of the inactivation procedure, inclusion of process controls, and an appropriate sampling strategy for subsequent inactivation by extraction.

Attenuation Methods

Attenuation is a method to minimize disease risk that involves using a weakened form of a pathogen, viral nucleic acid sequences, or a toxin. Attenuated pathogens generally have some combination of reduction in the agent's virulence, replication, and/or transmissibility (including host and tissue tropism). Attenuation methods, while lowering risks and potentially enabling work at a lower Biosafety Level, do not meet the criteria for classification as inactivation. A thorough risk assessment is needed to determine whether attenuation of an agent merits lowering of the Biosafety Level. Attenuation methods include anti-virulence compounds that target bacterial secretion systems, disarming rather than killing bacterial pathogens,^{25,32-34} and engineering of micro-RNA (miRNA) regulation systems to restrict viral tropism/host range.^{35,36} Reduction of containment level should never be considered for an attenuation system that results in only a temporary reduction of virulence.

Tables 11 and 12 outline the key advantages and disadvantages of two novel attenuation methods. First, natural and emerging antimicrobial strategies utilize anti-virulence compounds^{25,32–34} targeting bacterial secretion systems to disarm, rather than kill, bacterial pathogens. Bacterial secretion systems are capable of directly translocating key macromolecules directly into a host to modulate defense mechanisms, facilitating the survival of the agent. Anti-virulence compounds deprive bacteria of their virulence functions while preserving characteristics useful for research. Second, molecular biocontainment utilizes microRNA (miRNA) regulation and tropism^{35,36} to engineer miRNA (endogenous, small, non-protein coding RNAs; important regulators of gene expression) systems to limit a pathogen’s virulence, replication, and/or transmissibility, including tropism of viral agents (host range).

Table 11. Advantages of novel methods to attenuate pathogens

Consideration	Anti-virulence compounds	miRNA regulation
Applicability	N/A	Broad applicability through miRNA engineering
Efficacy	Broad-spectrum activity (especially Gram-negative)	Species-specific miRNA can attenuate while retaining replication and transmissibility in animal model(s)
Structural maintenance	N/A	Desired characteristics are relatively stable over long-term through engineered miRNA regulation
Residual toxicity	Low toxicity	Low toxicity
Resistance	Development of resistance delayed	N/A

Table 12. Disadvantages of novel methods to attenuate pathogens

Consideration	Anti-virulence compounds	miRNA regulation
Applicability	Limited to bacteria	N/A
Recoverability	N/A	Agent may regain infectivity; monitoring is required
Efficacy	Attenuation, not inactivation	Attenuation, not inactivation
Off-target effects	Unknown	Regulation of multiple genes may have unintended consequences

Continued on next page ►

Consideration	Anti-virulence compounds	miRNA regulation
Ease of use	Attenuation occurs at different times; diagnostic tests do not distinguish between pathogenic and non-pathogenic bacteria. Compound(s) that only suppress virulence while present should not be considered suitable for reduction in containment.	N/A

Process Verification

The validated inactivation procedure should be verified in the hands of the laboratorian performing the procedure while using the reagent sources and equipment intended for the routine process; verification occurs regardless of procedure source (i.e., commonly accepted, published, or in-house procedure). Run-to-run variability is due to the cumulative effect of variation, sometimes slight, in a number of factors including materials, equipment, pathogen concentration, environmental conditions, and the personnel performing that particular procedure. Verification of a validated inactivation procedure is necessary because run-to-run variations may result in somewhat different levels of efficacy.

Verification will need to be risk-based. For lower risk organisms, verification may be the printout from an autoclave that demonstrated adequate time and temperature for inactivation or results of a biological indicator. For higher risk organisms, verification involves testing for the absence of viability, infectivity, and toxicity; see Validation of Inactivation Procedures within this appendix. The purpose of process verification is to demonstrate that adequate efficacy is achieved despite these normal variations in run-to-run conditions.

Institutional Verification

While process verification applies to individual facilities at an institution, institutional verification refers to affirmation by the institution that the set of confirmed inactivation and separation/removal procedures used at that institution result in end-products that achieve adequate inactivation efficacy. It is the institution's responsibility to ensure that pathogens, viral nucleic acid sequences, and toxins handled at their institution are adequately inactivated (or decontaminated) in order to protect their workers, the public, and the environment and to ensure movement of the inactivated material to lower containment levels is appropriate.

Tracking of and Communication about Inactivated Samples

The institution should evaluate recordkeeping on the specifics of the inactivation protocol including its limitations; depending on the containment required for the live organism, one may need data on the risk assessment performed; data from

viability, infectivity, or toxicity testing; who performed the inactivation procedure; the date it was done; and where it was performed. Clear sample labeling is critical as it enables tracking of the identity of the material, inactivation status, inactivation date, and other relevant information. Should an inactivation failure occur, good recordkeeping will aid in informing any individuals who may have been exposed and could also prevent the samples from being moved to a lower containment level, if the failure is caught quickly, thus preventing potential occupational exposures. Internal and external recipients of any material that is not adequately inactivated must be notified promptly.

Good biosafety and laboratory biosecurity practices include communicating about any hazards that may be present in inactivated samples, information on the risk assessments performed for the inactivation and confirmation procedures, details of the institution's sampling strategy, appropriate labeling, robust training of the laboratorians, and retention of experimental data associated with inactivation verification. Thorough tracking of the inactivation and verification specifics is important for senders of shipments; internal recipients of the material and others at the institution who may be potentially exposed; individuals who may potentially be exposed during transport of the materials; and external recipients of shipments of inactivated biological materials. Use of the original level of containment for the intact pathogen may be merited if the inactivation status of incoming materials is uncertain.

Ongoing Review and Oversight of Inactivation and Verification Procedures

Inactivation procedures and methods to verify efficacy of inactivation procedures should be reviewed regularly (annually is recommended for high-risk agents, based on risk assessment for lower risk agents); when conditions (e.g., higher volumes or concentrations of material, temperature, matrix material) have differed from the pre-determined inactivation procedure conditions set by the confirmation study(ies); and when a previously verified inactivation procedure fails. The review of inactivation and verification procedures on a regular, ongoing basis is also essential in ensuring inactivation efficacy for evolving agents.

An investigation with a root cause analysis needs to be performed on failure of any previously verified inactivation procedure to determine what went wrong and how to prevent inactivation failures from happening in the future. Recurring issues with an inactivation or verification procedure warrant modification of the inactivation method or development of an alternative method(s) for future inactivation and verification procedures. An institution's sampling strategy should also be re-assessed periodically.

Other Important Considerations

Equipment and other components used in inactivation and verification procedures need to be regularly maintained in order to ensure consistent inactivation efficacy over time. Chemical and physical hazards of inactivation procedures should also be regularly assessed as part of the routine review of the procedures. OSHA's Laboratory Safety Guidance provides information on regulations and guidance for handling hazardous materials in the laboratory.³⁷

Training and evaluation of competency are key to achieving high levels of biosafety; consistency minimizes the risks of an incident occurring and limits negative consequences of an incident should one occur. Regular safety training should include information on current inactivation and verification procedures and information on any modified or new procedures; this information should be provided to all affected staff. Re-training after inactivation failure is appropriate to emphasize lessons learned from the root cause analysis of the inactivation failure. The effectiveness of a safety program is highly dependent on the safety culture at the institution—a strong safety culture with a proactive rather than a reactive approach is a key safeguard in prevention of laboratory incidents.

Conclusion

Inactivation and verification procedures need to be tailored to the specific procedural circumstances and based on a risk assessment. In-house testing is recommended for all methodologies due to the wide variability in conditions at different institutions; the inevitability of differences in assay conditions, equipment and/or reagent sources; and the varied conditions used for the different types of inactivation procedures. Gaps in knowledge of inactivation and verification methods mean there is often improvisation at the institutional level. One useful way to ensure that information on effective inactivation and verification methods is broadly shared with the scientific community is through inclusion of this important data in the "Materials and Methods" sections of publications.

Novel inactivation methods that enable retention of desired agent characteristic(s) are an area of active research in the field of biosafety, but additional work is needed. Advances in inactivation and verification procedures can improve safety and security, enable reduction of the Biosafety Level used and the costs, and allow forward movement in some valuable research projects that might otherwise face obstacles.

References

1. Federal Select Agent Program [Internet]. Atlanta and Riverdale: Centers for Disease Control and Prevention, Division of Select Agents and Toxins and Animal and Plant Health Inspection Services, Agriculture Select Agent Services; c2017 [cited 2018 Dec 26]. Guidance on the Inactivation or Removal of Select Agents and Toxins for Future Use. Available from: https://www.selectagents.gov/resources/Inactivation_Guidance.pdf
2. Van Impe J, Smet C, Tiwari B, Greiner R, Ojha S, Stulić V, et al. State of the art of nonthermal and thermal processing for inactivation of micro-organisms. *J Appl Microbiol*. 2018;125(1):16–35.
3. Mbonimpa EG, Blatchley ER 3rd, Applegate B, Harper WF Jr. Ultraviolet A and B wavelength-dependent inactivation of viruses and bacteria in the water. *J Water Health*. 2018;16(5):796–806.
4. Farcet MR, Kreil TR. Zika virus is not thermostable: very effective virus inactivation during heat treatment (pasteurization) of human serum albumin. *Transfusion*. 2017;57(3pt2):797–801.
5. Spotts Whitney EA, Beatty ME, Taylor TH Jr, Weyant R, Sobel J, Arduino MJ, et al. Inactivation of *Bacillus anthracis* spores. *Emerg Infect Dis*. 2003;9(6):623–7.
6. Cote CK, Buhr T, Bernhards CB, Bohmke MD, Calm AM, Esteban-Trexler JS, et al. A Standard Method to Inactivate *Bacillus anthracis* Spores to Sterility Using γ -Irradiation. *Appl Environ Microbiol*. 2018.
7. Elliott LH, McCormick JB, Johnson KM. Inactivation of Lassa, Marburg, and Ebola viruses by gamma irradiation. *J Clin Microbiol*. 1982;16(4):704–8.
8. Vaidya V, Dhare R, Agnihotri S, Muley R, Patil S, Pawar A. Ultraviolet-C irradiation for inactivation of viruses in foetal bovine serum. *Vaccine*. 2018;36(29):4215–21.
9. Blázquez E, Rodríguez C, Ródenas J, Pérez de Rozas A, Segalés J, Pujols J, et al. Ultraviolet (UV-C) inactivation of *Enterococcus faecium*, *Salmonella choleraesuis* and *Salmonella Typhimurium* in porcine plasma. *PLoS One*. 2017;12(4):e0175289.
10. Vatansever F, Ferraresi C, de Sousa MV, Yin R, Rineh A, Sharma SK, et al. Can biowarfare agents be defeated with light?. *Virulence*. 2013;4(8):796–825.
11. Blow JA, Dohm DJ, Negley DL, Mores CN. Virus inactivation by nucleic acid extraction reagents. *J Virol Methods*. 2004;119(2):195–8.
12. Haddock E, Feldmann F, Feldmann H. Effective Chemical Inactivation of Ebola Virus. *Emerg Infect Dis*. 2016;22(7):1292–4.
13. Rosenstierne MW, Karlberg H, Bragstad K, Lindegren G, Stoltz ML, Salata C, et al. Rapid Bedside Inactivation of Ebola Virus for Safe Nucleic Acid Tests. *J Clin Microbiol*. 2016;54(10):2521–9.

14. Roberts PL, Lloyd D. Virus inactivation by protein denaturants used in affinity chromatography. *Biologicals*. 2007;35(4):343–7.
15. Hughson AG, Race B, Kraus A, Sangaré LR, Robins L, Groveman BR, et al. Inactivation of Prions and Amyloid Seeds with Hypochlorous Acid. *PLoS Pathog*: 2016;12(9):e1005914.
16. Rose LJ, Rice EW, Jensen B, Murga R, Peterson A, Donlan RM, et al. Chlorine inactivation of bacterial bioterrorism agents. *Appl Environ Microbiol*. 2005;71(1):566–8.
17. Dembinski JL, Hungnes O, Hauge AG, Kristoffersen AC, Haneberg B, Mjaaland S. Hydrogen peroxide inactivation of influenza virus preserves antigenic structure and immunogenicity. *J Virol Methods*. 2014;207:232–7.
18. Sagripanti JL, Hülseweh B, Grote G, Voss L, Böhring K, Marschall HJ. Microbial inactivation for safe and rapid diagnostics of infectious samples. *Appl Environ Microbiol*. 2011;77(20):7289–95.
19. Schneider K, Wronka-Edwards L, Leggett-Embrey M, Walker E, Sun P, Ondov B, et al. Psoralen Inactivation of Viruses: A Process for the Safe Manipulation of Viral Antigen and Nucleic Acid. *Viruses*. 2015;7(11):5875–88.
20. Laughhunn A, Huang YS, Vanlandingham DL, Lanteri MC, Stassinopoulos A. Inactivation of chikungunya virus in blood components treated with amotosalen/ultraviolet A light or amustaline/glutathione. *Transfusion*. 2018;58(3):748–57.
21. Santa Maria F, Laughhunn A, Lanteri MC, Aubry M, Musso D, Stassinopoulos A. Inactivation of Zika virus in platelet components using amotosalen and ultraviolet A illumination. *Transfusion*. 2017;57(8):2016–25.
22. Nakano R, Ishiguro H, Yao Y, Kajioaka J, Fujishima A, Sunada K, et al. Photocatalytic inactivation of influenza virus by titanium dioxide thin film. *Photochem Photobiol Sci*. 2012;11(8):1293–8.
23. Kashef N, Huang YY, Hamblin MR. Advances in antimicrobial photodynamic inactivation at the nanoscale. *Nanophotonics*. 2017;6(5):853–79.
24. Takahashi H, Tsuchiya T, Takahashi M, Nakazawa M, Watanabe T, Takeuchi A, et al. Viability of murine norovirus in salads and dressings and its inactivation using heat-denatured lysozyme. *Int J Food Microbiol*. 2016;233:29–33.
25. Lambert MS. An update on alternatives to antibiotics—old and new strategies. *Appl Biosaf*. 2011;16(3):184–7.
26. Takahashi M, Okakura Y, Takahashi H, Imamura M, Takeuchi A, Shidara H, et al. Heat-denatured lysozyme could be a novel disinfectant for reducing hepatitis A virus and murine norovirus on berry fruit. *Int J Food Microbiol*. 2018;266:104–8.

27. Singh VP. Recent approaches in food bio-preservation—a review. *Open Vet J.* 2018;8(1):104–11.
28. Tomat D, Casabonne C, Aquili V, Balagué C, Quiberoni A. Evaluation of a novel cocktail of six lytic bacteriophages against Shiga toxin-producing *Escherichia coli* in broth, milk and meat. *Food Microbiol.* 2018;76:434–42.
29. Gomes C, Moreira RG, Castell-Perez E. Microencapsulated antimicrobial compounds as a means to enhance electron beam irradiation treatment for inactivation of pathogens on fresh spinach leaves. *J Food Sci.* 2011;76(6):E479–88.
30. Chai C, Lee KS, Imm GS, Kim YS, Oh SW. Inactivation of *Clostridium difficile* spore outgrowth by synergistic effects of nisin and lysozyme. *Can J Microbiol.* 2017;63(7):638–43.
31. Joo HS, Fu CI, Otto M. Bacterial strategies of resistance to antimicrobial peptides. *Philos Trans R Soc Lond B Biol Sci.* 2016;371(1695).
32. Baron C. Antivirulence drugs to target bacterial secretion systems. *Curr Opin Microbiol.* 2010;13(1):100–5.
33. Paschos A, den Hartigh A, Smith MA, Atluri VL, Sivanesan D, Tsois RM, et al. An in vivo high-throughput screening approach targeting the type IV secretion system component VirB8 identified inhibitors of *Brucella abortus* 2308 proliferation. *Infect Immun.* 2011;79(3):1033–43.
34. Sharifahmadian M, Arya T, Bessette B, Lecoq L, Ruediger E, Omichinski JG, et al. Monomer-to-dimer transition of *Brucella suis* type IV secretion system component VirB8 induces conformational changes. *FEBS J.* 2017;284(8):1218–32.
35. Langlois RA, Albrecht RA, Kimble B, Sutton T, Shapiro JS, Finch C, et al. MicroRNA-based strategy to mitigate the risk of gain-of-function influenza studies. *Nat Biotechnol.* 2013;31(9):844–7.
36. Lambert MS. Safety overview of techniques involving miRNAs, siRNAs, and other small regulatory RNAs. *Appl Biosaf.* 2009;14(3):150–2.
37. United States Department of Labor [Internet]. Washington (DC): Occupational Safety and Health Administration; c2011 [cited 2018 Dec 27]. Laboratory Safety Guidance. Available from: <https://www.osha.gov/Publications/laboratory/OSHA3404laboratory-safety-guidance.pdf>

Appendix L—Sustainability

Introduction and Issues

Sustainability is the ability to satisfy current needs without depleting resources needed for the future. The phrase “triple bottom line” (e.g., “people-planet-profit”) is often associated with sustainability to explain the benefits of balancing the financial bottom line with environmental and social goals in order to find effective solutions that can stand the test of time without compromising human health.

While safety remains of utmost importance in design and/or operation of a laboratory, minimizing waste and safeguarding long-term human health through protection of the environment is a high priority. Design, construction, and operation of sustainable laboratories requires a holistic approach that considers the interconnectedness of building systems. The project delivery process can be optimized with an integrated design approach and by establishing multi-disciplinary evaluation of issues regarding both the current uses and the potential future uses of a building.

Laboratories consume more resources and energy per square foot than other commercial buildings. Factors influencing laboratory energy consumption include: continuous operation, ventilation needs at exhaust devices, energy-intensive and heat-generating equipment, and use of water for steam sterilization and other processes. Furthermore, critical research and containment requirements in laboratories often require electrical power system redundancy to remain fail-safe.

This appendix outlines potential opportunities to increase the efficiency of the laboratory portion of buildings to achieve energy and cost savings, decrease pollution, and optimize material resource use. The appendix also highlights strategies to improve indoor air quality and lighting in order to increase productivity, improve worker comfort and well-being, and reduce maintenance issues related to occupant comfort.

Strategies for Existing Laboratories and Operations

Sustainability approaches within laboratories usually focus on design and construction of new facilities. However, improvements to operational and management practices of existing laboratories can yield meaningful savings and conserve material resources.

Commissioning

Commissioning, a process to verify systems are working as intended, has demonstrated median savings of 15% in existing buildings; laboratories have shown an average payback of retro-commissioning costs of one year or less.¹ Facility Managers might consider retro-commissioning, starting with an audit to assess energy and water consumed in the laboratory. When auditing, include

retro-commissioning of equipment when possible. Systematic evaluation of equipment can identify problems that developed as equipment aged or as building uses changed. For example, recalibrating a temperature sensor is inexpensive but improves diagnostics and/or monitoring. Correcting a variable-frequency drive motor controller that operates at an unnecessarily high-speed saves energy and money over time without incurring significant first-cost.

Water and Energy Efficiency

Evaluate measures to improve energy and water efficiency in response to findings from the audit. Simple measures, such as upgrading to energy-efficient lighting or implementing after-hours airflow reduction (i.e., setbacks), can be taken. Conserve water by adding shut-off sensors and clearly labeling fixtures with instructional signage for occupants.

Evaluating Energy Efficiencies Using Audits

Develop a strategic approach prior to implementing the audit. Expand the audit process to evaluate material waste and to determine the effectiveness of any waste management strategies already in place. Follow the guidance in an approved or appropriate document such as Document 203, Health Care Waste Management Audit Procedures—Guidance, which was developed with the support of the CDC.²

1. Compare the percentage by weight of recyclable and non-recyclable items to total waste to evaluate effectiveness of recycling strategies.
2. Identify and focus strategies to reduce major contributors to the waste stream.
3. Donate unneeded, but functional, equipment instead of sending it to a landfill. Properly decommission and disinfect any potentially contaminated items prior to donating.
4. Evaluate recycling potential in terms of procurement goals. For example:
 - a. An audit in a non-containment laboratory showing an abundance of PPE gloves could lead to a procurement preference for nitrile gloves since nitrile gloves not used with infectious materials are potentially recyclable.
 - b. Establish purchasing guidelines to define minimum or recommended amounts of recycled plastic in conical centrifuge tubes.
 - c. Purchase reusable autoclavable reagent reservoirs, where feasible, to reduce plastic waste.
5. Include vivaria in waste inventories. Consider the following where appropriate:
 - a. Compost non-infectious bedding and discarded feed instead of landfilling or incinerating it.
 - b. Change cage bedding based on use or ammonia level vs. on a schedule.

Energy Use in Laboratories and Potential Initiatives

Plug-in equipment such as autoclaves, centrifuges, and freezers account for up to half of the energy used in a typical laboratory. In addition to generating heat during operation, freezers consume a significant portion of that energy demand. Consider creating an internal competition or participating in the International Laboratory Freezer Challenge, a competition designed to promote sample integrity and reduce costs and energy.³ Implement the best practices outlined in the Challenge's protocol: clean refrigerant coils to optimize performance; create searchable inventories to shorten the time freezer doors are open and reduce time spent locating samples; and reset Ultra-Low Temperature (ULT) Freezers from -80°C to -70°C to reduce energy consumption without having a discernible impact on temperature stability.⁴ If equipment needs replacement, opt for more efficient models. See 3. Strategies for New and Renovated Laboratories, below, for recommendations.

Identify areas of potential inefficiencies related to occupant behavior in laboratory areas. For example:

1. Explore the impact of shutting chemical fume hoods using variable air volume controls when not in use. Harvard University implemented a “Shut the Sash” Program, which calculated utility savings of \$200,000–\$250,000 per year in the Department of Chemistry and Chemical Biology (houses 278 chemical fume hoods).⁵
2. Turn off autoclaves (except for constant-bleed autoclaves or those that are equipped with a sleep mode) at night and over weekends.
3. Forgo the drying stage in tunnel washers for Vivarium cages and allow cleaned cages to air-dry.

Good practices emphasize laboratory-specific operations and control strategies while better practices improve the ventilation design process with advanced computer or physical modeling techniques.⁶

Most energy use in laboratories is related to ventilation. Use tracer gas tests following the ASHRAE Laboratory Design Guide to calculate the air-changes per hour in an existing laboratory. Conduct airflow simulations to evaluate scenarios regarding spills or aerosols to reveal opportunities for improvement in ventilation component efficiency. Introduce neutrally buoyant helium-filled soap bubbles to a space to provide a visual evaluation of laboratory airflow. As the bubbles reach room temperature, they follow tiny air currents.

Develop “Green Chemistry” initiatives and protocols to reduce chemical waste at the source. Reduce or eliminate the use of hazardous chemical reagents, solvents, and products to save space and water while reducing hazardous waste and carbon dioxide releases. Understand the toxicology of chemicals in use as well as the principles of Green Chemistry outlined by the EPA.⁷ Conduct an

inventory of hazardous chemicals in use and develop a systematic process to reduce or eliminate those chemicals using alternate methods or replacing them. Explore databases regarding alternative methods and alternative chemicals such as the “Green” Alternatives Wizard, which is a searchable online database developed by the Massachusetts Institute of Technology (MIT).⁸ Try to use chemicals that are less toxic, biodegradable after use, do not deplete ozone, and/or do not form smog. Consider less hazardous chemical alternatives, such as the use of fluoruous solvents instead of chlorinated ones.

Eliminate chemicals when feasible. Allow glass to dry instead of using acetone. Avoid use of reaction solvents if crushing solids together will suffice.

In addition to the strategies above, consider use of general operational and maintenance guidance provided in well-established green building rating systems.^{9–13}

Strategies for New and Renovated Laboratories

A sustainable design approach should result in a project with improved utility of spaces, enhanced occupant comfort and well-being, right-sizing of equipment, and protection of the environment.

Pre-Design

In terms of sustainability, the most critical activity in laboratory planning begins before the design phase. The goal of pre-design activities is to provide information necessary for a design team to develop a robust programming document, which is the cornerstone of a sustainable, high-performance building.

Define design intent by developing an Owner’s Project Requirements (OPR) document. Identify performance requirements from the perspective of stakeholders including the researchers, directors, technicians, operators, community, and any other parties that will be affected by the outcome of the laboratory design. Carefully outline the stakeholders’ specific requirements for the proposed use of each space. Differentiate between an actual requirement and a wish-list.

In addition to addressing aspects of safety requirements, define the requirements and base assumptions about the use of the laboratories and other spaces. Include the hours and conditions when a space is likely to be occupied, partially occupied, or unoccupied. Identify areas where worker schedules are most predictable. This will allow coordination to evaluate lighting or other system controls that may be shut off or adjusted automatically to save energy. Comment on the acceptable time-period for system start-ups during unanticipated or emergency use. Include considerations for potential changes in laboratory uses or sizes over time. This enables a design team to explore the possible impact on support utilities such as supply and exhaust of air as well as various

configurations of laboratory benches/casework. Establish goals for energy and water efficiency. Include comments on how success in meeting those goals will be measured. Identify laboratories that do not need a narrow range of humidity and/or thermal control. *Laboratories for the 21st Century*¹⁴ estimates that too narrow a range of acceptable humidity can increase energy use by as much as 25%. Identify spaces where daylight is appropriate and does not hinder the proposed research. This enhances workers' well-being and reduces the need for artificial illumination during the daytime.

Design

Engage a design team with proven experience in designing sustainable laboratories. Require an "Integrative Process" meeting to be attended by key laboratory personnel, facility managers, and as many members of the design team as feasible. This meeting will support development of a formal program for use by the design team as they develop design and construction documents. At the meeting, collectively review the OPR described above. Have attendees discuss their concerns and strategies for all primary objectives stated in the OPR. Establish a protocol that requires consideration of multiple factors in addition to safety. This includes life-cycle cost, flexibility, site conditions, indoor environment, environmental impact, renewable energy, and the efficient use of water, energy, and materials. Determine how success of meeting the OPR will be measured at each subsequent phase of the project.

Sustainable Design Strategies

Renovation or construction of new laboratories should avoid automatic replication of solutions from other laboratories. Solutions should be customized but adaptable. Stakeholders may benefit by becoming generally familiar with laboratory construction recommendations that incorporate sustainability topics.^{15–18}

Acoustics Specific equipment and activities in each laboratory may impact communication and create noise that, if unaddressed, can increase occupant fatigue. A laboratory space with noisy equipment (e.g., fume hood) should not be designed with the same noise criterion (NC) as a dry, computational space or a classroom.^{19,20}

Artificial Lighting Efficiency and Quality Moderate levels of acceptable, ambient (i.e., general) lighting combined with task lighting (where specifically needed) are key components to efficient and effective lighting design. When looking to save energy, use automatic shut-off or dim ambient lighting in spaces or zones where schedules are predictable. The intensity and color of light as well as the contrast level between lit surfaces will impact the workers' visual comfort. Lighting built into a fume hood or biosafety cabinet can be coordinated with the color of ambient lighting to enhance that visual comfort.

Flexible laboratory bay configurations requiring workbench mobility require consideration regarding bench-mounted task lighting as well as the reduced lighting level that may result when a bench has been moved away. Consideration should be given to the chemicals in use near heat-generating, under-cabinet task lights.

Evaluate the lighting aspects of laboratory bench configuration mock-ups. Mock-ups should include the proposed color(s) for the work surface, a portion of proposed ceiling, and any major ceiling elements (such as an air diffuser) that may impact the perception of light levels or visual contrast.

For additional information on New Buildings Institute Advanced Lighting Guidelines (AGL Online), please visit <https://newbuildings.org/resource/advanced-lighting-guidelines>. For additional information on the Illuminating Engineering Society, please visit <https://www.ies.org/>, <https://www.ihs.com/products/iesna-standards.html> or refer to the NIH Design Requirements Manual.¹⁵

Automated Energy Monitoring and Control System (EMCS) Projects including an EMCS can track the details of energy consumption and performance through sub-meters that relay information to the EMCS. Loads for HVAC (heating, ventilation, and air-conditioning), lighting, and plug-in equipment should be monitored separately, as should large loads like those for chillers.

Dynamic or demand control may be useful when a laboratory's Biosafety Level classification is low and chemical hazards are also low, based on risk assessments. The control reduces air-change rates when sensors indicate good air quality. Air quality is typically determined by establishing maximum thresholds of total volatile organic compounds (TVOC) and small particulates.

Biophilia Biophilia suggests that humans have an instinctive affiliation with nature and other living systems. It can be used as a design strategy. Provide visual connections to symbolic foliage, organic forms, and sunlight to foster psychological well-being and cognitive function.²¹

Chilled Beams Chilled beams are appropriate for laboratories without a high density of fume hoods or for laboratories that do not require a high rate of airflow changes. They minimize energy used for tempering air by separating the heating and cooling functions from the ventilation. The "beam" contains elements for sensible cooling using cold water (with a temperature above the dew point) that circulates through coils. Ventilation is provided by parallel elements tied to a central air handling system. The air-temperature required to condition the space with either the greatest heating or the greatest cooling load drives the design.

These systems require additional piping and are likely to incur more initial cost, but they ultimately save money due to significantly smaller central air-handling

systems and ducts. There are currently limited data regarding the use of chilled beam technology in high containment laboratories.

Commissioning See Strategies for Existing Laboratories and Operations, above, for more information regarding Commissioning. Also see the ANSI Z9.14 Standard, Testing and Performance-Verification Methodologies for Ventilation Systems for Biosafety Level 3 (BSL-3) and Animal Biosafety Level 3 (ABSL-3) Facilities.²²

Daylight and Glare Control Natural daylight is an efficient lighting source and enhances occupant well-being. Design elements and devices to control and prevent glare are critical to worker comfort. This should increase energy savings through reduction of heat gain. Fortunately, numerous options are available for new spaces. Options may include:

1. Interior sun shading devices, such as blinds or shades, outside of laboratory space;
2. Exterior sun shading, which may be fixed or can be automated to adjust in response to time of day or sun angle; and
3. Glass that is fritted or coated with film or that changes transparency through electrochromic or thermodynamic properties. Note that this glazing can also be specified with features that reduce bird collision.

Energy Recovery Transfer of heat energy generated in one space or system to another space or system can save substantial amounts of energy and allow for smaller, less costly heating and cooling systems. Enthalpy wheels, heat pipes, and run-around loops, which transfer heat across air streams, should be considered; concerns regarding odor, biological, and chemical contamination may preclude their use. It should be noted that the heated air must be directed towards the laboratories where the exhaust air came from to minimize the potential for any cross-contamination in the event of a leak within the transfer system.

Evaluate energy recovery from common systems that serve laboratories with varying (low and high) loads during operation. Heated air from laboratories with heat-generating equipment and occupants can be used to pre-heat a space that is too cool. Additional space may be required for some recovery systems, such as heat pipe systems or rotary exchangers (e.g., enthalpy or desiccant wheels).

Exhaust Review energy efficiency and flexibility when evaluating fume hoods. For BSL-1 and BSL-2 laboratories, consider allowing manifold exhaust.

Conducting a Computational Fluid-Dynamics (CFD) Model will evaluate airflow patterns. These performance-based simulations can be used to evaluate safety and optimize airflow in a given scenario (e.g., the time needed to clear a chemical).

Flexibility A building that is designed to be flexible will accommodate future needs without radical renovation; this could save material resources and funds.

The Whole Building Design Guide, a web-based portal with up-to-date information on planning and designing research laboratories, provides recommendations for incorporating flexibility into laboratory design.²³ Passageway and doorway width should be designed to accommodate larger equipment than originally scheduled, such as autoclaves and cage racks. Provide wide pathways between loading docks and locations for large equipment. Vertical expansion to accommodate additional fume hoods should be considered.

Greywater Reuse Non-potable (e.g., greywater) is water that has not come into contact with sewage, biological agents, radioisotopes, or toxic chemicals. Greywater may be reused outside of the laboratory for functions, such as toilet-flushing or landscape irrigation. Polished water (i.e., salts or microscopic particulates are removed) resulting from laboratory processes is a potential source of reusable water.

Ventilation The profound impact of ventilation on energy use makes evaluation of the appropriate number of air-changes in each laboratory critical. Do not automatically replicate design or air-changes from similar projects. Balance safety and energy concerns by allowing designs for spaces with less stringent safety classifications to have fewer air-changes.

In addition to the design considerations noted above, review specifications for the proposed equipment in terms of energy and water efficiency. Consider giving preference to laboratory-grade refrigerators and/or freezers and ultra-low temperature (ULT) freezers that do not exceed the maximum energy consumption; the EPA's Energy Star program provides such specifications.²⁴ Freezer selection in new or renovated laboratories typically has the largest impact on energy consumption of any single equipment group other than those related to ventilation. Give preference to ULT freezers that use natural refrigerants and vacuum-insulated panels. Note that an energy-efficient ULT operating at -80°C uses more energy than at -70°C.

Additional items to consider:

1. Evaluate specifying autoclaves that use less water in the cooling process, typically through regulation, sometimes via facility-chilled water loop when chiller capacity allows.
2. Add a system to cool effluent in retrofit situations.
3. Specify water and energy-efficient vivarium cage washers.
 - a. Use final rinse water for the initial cycle and incorporate heat exchangers to recapture heat from overflow rinse water in order to reduce overall steam and cold water consumption.

4. Incorporate a recirculation system that pumps water back to the vacuum system of the autoclave.
 - a. Recirculation systems and some heat exchange systems with improved autoclave functions can require more space.

References

1. Mills E, Bourassa N, Pipette MA, Friedman H, Haas T, Powell T, et al. The Cost-Effectiveness of Commissioning New and Existing Commercial Buildings: Lessons from 224 Buildings. In: National Conference on Building Commissioning; 2005 May 4–6. p. 1–22.
2. Health Care Without Harm [Internet]. Health Care Waste Management Audit Procedures—Guidance; c2018 [cited 2018 Dec 14]. Document 203. Available from: <https://noharm-global.org/documents/health-care-waste-management-audit-procedures-guidance>
3. freezerchallenge.org [Internet]. International Laboratory Freezer Challenge; c2018 [cited 2018 Dec 14]. Available from: <https://www.freezerchallenge.org/>
4. Emerging Technologies Coordinating Council [Internet]. Ultra-Low Temperature Freezers: Opening the Door to Energy Savings in Laboratories; c2016 [cited 2018 Dec 14]. Available from: <https://www.etcc-ca.com/reports/ultra-low-temperature-freezers-opening-door-energy-savings-laboratories>
5. Harvard University [Internet]. Cambridge (MA): Shut the Sash Program; c2018 [cited 2018 Dec 14]. Validating Cost and Energy Savings from Harvard's Shut the Sash Program: Tackling Energy Use in Labs. Available from: <https://green.harvard.edu/programs/green-labs/shut-sash-program>
6. Bell GC. Laboratories for the 21st Century: Best Practice Guide. Optimizing Laboratory Ventilation Rates. Washington (DC): U.S. Environmental Protection Agency; 2008.
7. U.S. Environmental Protection Agency [Internet]. Washington (DC): Green Chemistry; c2017 [cited 2018 Dec 14]. Basics of Green Chemistry. Available from: <https://www.epa.gov/greenchemistry/basics-green-chemistry#twelve>
8. ehs.mit.edu/greenchem [Internet]. "Green" Alternatives Wizard; c2018 [cited 2018 Dec 14]. Available from: <http://ehs.mit.edu/greenchem/>
9. BREEAM® [Internet]. San Francisco (CA): Refurbishment and Fit-Out Technical Standard; c2018 [cited 2018 Dec 17]. Available from: <https://www.breeam.com/refurbishment-and-fit-out>
10. BREEAM® [Internet]. San Francisco (CA): New Construction Technical Standards; c2018 [cited 2018 Dec 17]. Available from: <https://www.breeam.com/new-construction>
11. LEED Reference Guide for Building Design and Construction. Washington (DC): U.S. Green Building Council; 2013.

12. LEED Reference Guide for Building Operations and Maintenance. Washington (DC): U.S. Green Building Council; 2013.
13. International WELL Building Institute. The WELL Building Standard®. Version 1.0. New York: Delos Living, LLC; 2014.
14. Langerich S, Lilly E, et al. Laboratories for the 21st Century: Best Practice Guide. Commissioning Ventilated Containment Systems in the Laboratory. Washington (DC): U.S. Environmental Protection Agency; 2008.
15. National Institutes of Health [Internet]. Bethesda (MD): Office of Research Facilities; c2018 [cited 2018 Dec 17]. Design Requirements Manual. Available from: <https://www.orf.od.nih.gov/PoliciesAndGuidelines/BiomedicalandAnimalResearchFacilitiesDesignPoliciesandGuidelines/Pages/DesignRequirementsManual2016.aspx>
16. International Institute for Sustainable Laboratories [Internet]. Washington (DC): U.S. Environmental Protection Agency, Department of Energy; c2018 [cited 2018 Dec 21]. Labs21 Tool Kit. Available from: <http://www.i2sl.org/resources/toolkit.html>
17. wbdg.org [Internet]. Washington (DC): Whole Building Design Guide; c2018 [cited 2018 Dec 17]. Available from: <http://www.wbdg.org/>
18. Energy.gov [Internet]. Washington (DC): Office of Energy Efficiency & Renewable Energy; c2018 [cited 2018 Dec 17]. Federal Energy Management Program. Laboratories. Available from: <https://www.energy.gov/eere/femp/energy-efficiency-laboratories>
19. Acoustical Performance Criteria, Design Requirements, and Guidelines for Schools, Part 1: Permanent Schools. ANSI/ASA S12.60-2010. Acoustical Society of America. Accessed 2018 Dec 17: https://successforkidswithhearingloss.com/wp-content/uploads/2012/01/ANSI-ASA_S12.60-2010_PART_1_with_2011_sponsor_page.pdf
20. Lab Manager [Internet]. Canada: LabX; c2018 [cited 2018 Dec 17]. Laboratory Acoustics. Available from: <https://www.labmanager.com/lab-design-and-furnishings/2011/11/laboratory-acoustics#>
21. Terrapin Bright Green [Internet]. New York: Terrapin Bright Green, LLC; c2014 [cited 2018 Dec 17]. 14 Patterns of Biophilic Design: Improving Health & Well-Being in the Built Environment. Available from: <https://www.terrapinbrightgreen.com/reports/14-patterns>
22. Testing and Performance-Verification Methodologies for Ventilation Systems for Biosafety Level 3 (BSL-3) and Animal Biosafety Level 3 (ABSL-3) Facilities, ANSI/ASSE Z9.14 (2014).
23. Whole Building Design Guide [Internet]. Washington (DC): Design Recommendations; c2017 [cited 2018 Dec 17]. Research Laboratory. Available from: <https://www.wbdg.org/building-types/research-facilities/research-laboratory>

24. Energy Star [Internet]. Washington (DC): U.S. Environmental Protection Agency, Department of Energy; c2016 [cited 2018 Dec 17]. ENERGY STAR® Program Requirements for Laboratory Grade Refrigerators and Freezers. Available from: <https://www.energystar.gov/sites/default/files/ENERGY%20STAR%20V1.1%20Lab%20Grade%20Refrigerator%20and%20Freezer%20Program%20Requirements.pdf>

Appendix M—Large-Scale Biosafety

Introduction

When working with biological agents in large-scale quantities, there are unique considerations that must be addressed in order to ensure worker and environmental protection. Large-scale biological production facilities should use the laboratory scale principles of risk assessment set forth in BMBL [Section II](#), and by ISO 35001, Biorisk Management for Laboratories and Other Related Organizations.

In addition to laboratory scale risk assessment requirements, the utilization of larger equipment and volumes of chemicals or raw materials requires risk management strategies beyond biological safety alone. The following sections apply risk management steps to give readers the most pertinent information for managing risk in large-scale production. The recommendations assume that those performing risk assessments for large-scale work will involve industrial hygienists and other process safety specialists when implementing risk assessment and control measures for large-scale operations.

Appendix K of *NIH Guidelines for Research Involving Recombinant or Synthetic Nucleic Acid Molecules (NIH Guidelines)* prescribes safety practices and containment procedures for large-scale (i.e., >10 liters per container) facilities. These guidelines can be applied to all large-scale work with biological materials (e.g., genetically modified organisms [GMO] and non-GMO, human, and animal/zoonotic pathogens). Please ensure familiarity with local regulations as these may differ from recommendations in this text.

Risk Assessment

Integrate the steps and processes utilized in laboratory biological risk assessment for any large-scale project. Risk assessment should be done during planning, when elements of the process change, and during periodic reviews of existing biological production processes, particularly after incidents or process failures. Risk control measures must be installed to mitigate unacceptable risk. Systems must be evaluated to determine their contribution to risk. The Good Practice quality guidelines and regulations (GxP) include three commonly used GxPs: Good Clinical Practices (GCP), Good Laboratory Practices (GLP),¹ and Good Manufacturing Practices (GMP);² GxP product Impact Assessment (IA) analysis can be extended to evaluate biosafety and laboratory biosecurity-related systems that govern exposure control, process room and environmental protection, decontamination, access control and accountability. Risk assessments should focus on the biological, chemical, physical, product, and equipment biosafety and laboratory biosecurity risk points. Production technologies and equipment with the potential for misuse (laboratory biosecurity/dual-use/export control) may also be

included in the risk assessment. Subject matter experts in engineering; Heating, Ventilation, and Air Conditioning (HVAC); quality control; occupational health; security; and health, safety, and environment (HSE) should always be consulted when making risk-based determinations.

Hazard Identification

The first step of risk assessment is hazard identification. Review additional factors that are unique to large-scale biological processes. Additional factors include but are not limited to:

1. Unique strains utilized primarily for research or manufacturing processes (e.g., producing high titers of a toxin);
2. High volumes (>10 liters) and high concentrations of product;
3. Specialized equipment and processes with unique risk points require a Hazard Analysis of Critical Control Points and/or Hazard and Operability studies;
4. Pressurized vessels and lines for biological and chemical reactions pose a risk for aerosol generation (e.g., bioreactors, fermenters, thermal inactivation tanks); and
5. Atypical routes of transmission (e.g., inhalation of biological agents or toxins not normally transmitted via the aerosol route).

Non-biological hazards to consider when performing a risk assessment may include, but are not limited to:

1. Hazardous chemicals: formaldehyde or similar for inactivation, large quantities of detergents, disinfectants and caustics, adjuvants, preservatives, solvents for down-stream processing, allergens or toxins, and asphyxiants;
2. Physical hazards: noise, steam, heat, cold, and radiation including UV and lasers;
3. Life-safety hazards: confined space, working at heights, line breaking, and pressurized systems;
4. Ergonomics;
5. Process safety-relevant controls (e.g., fire/explosions; pressurized systems);
6. Preventative maintenance (PM): solid and process effluent waste streams and control measures employed, including PM of relevant equipment;
7. Processes to control release of material (i.e., human and environmental risks), including corresponding emergency procedures; and
8. Risk points associated with equipment.

Hazard Evaluation

As with laboratory risk assessment, the hazards associated with the biological agent/material and process equipment must be evaluated. In addition, the operational integrity of containment equipment and facility safeguards and the capability of area staff to effectively control potential hazards must be considered. Staff capability will depend on the training, technical proficiency, and good habits of all team members.

Large-scale research and production pose additional risks that require evaluation. Increased growth, vessel size, and enhanced aeration magnify the aerosol generation risk. By design, the biological agent concentration is greatly increased. Therefore, protection from aerosol transmission must be considered for agents normally transmitted by insect bite or injection.

Chemical risks are also increased due to handling of dry powders for media preparation, pumping of acid or base for pH control, and preparation/addition of inactivation chemicals for vaccine preparation. Closed system transfer technology may be foreign to those with experience limited to the laboratory.

Risks due to hazardous energy (i.e., electrical, steam, pressurized gases) are also magnified. Hazardous energy control procedures such as removing the power cord or closing a supply valve become complex and may be poorly understood by those with experience limited to the laboratory.

Risk Control

Risk mitigation strategies identified in large-scale research and production follow the same principles (i.e., hierarchy of controls) established to control HSE risks.³ Those performing risk assessments for large-scale work may be able to eliminate a hazard or substitute to reduce risk. When this is not possible, engineering, administrative and/or work practice controls, and PPE are utilized.

Engineering Controls

Selecting the proper engineering solution is an iterative process.^{4,5} The design provisions for a large-scale biological production facility will differ greatly depending on whether the work is dealing with an exotic, indigenous, eradicated, novel, or emerging disease-causing agent; a highly allergenic compound; a GMO, carcinogenic or highly toxic product; or a well-characterized and attenuated childhood vaccine.

Many controls must be considered in the process, including HSE-risk, biosafety, and laboratory biosecurity. In addition, large-scale GxP facilities must evaluate quality design controls for product as well as personnel and environmental protection. Consider state and local regulations when implementing the design of

a large-scale biological production facility. A large-scale facility balancing GxP and biosafety requirements will need to evaluate the following basic facility principles:

Clean to Dirty The process design must include controls to prevent contamination spread within the facility and to the environment. If applicable, an assessment of conflicts between GxP and biosafety requirements must also occur to achieve two different definitions of clean. If there are two competing requirements, implement controls that address the highest consequence events and identify alternate methods to meet the intent of the competing requirement. For example, if an operation requires positive-pressure environment to achieve product protection, you can create an air pressure sink in an anteroom to ensure containment of the biological agent.

Change Rooms and Barriers Establish donning and doffing needs by creating an operational flow diagram. This will help clarify how many actions an operator must take for a given procedure or process step when passing through a personnel barrier or door. The review should cover normal operations, planned and unplanned maintenance, and emergencies. This process should identify the potential demand in PPE for the facility, the number and locations of room(s), and room size(s) necessary for storing PPE and changing. Facilities covered by GxP requirements must consider PPE and workflow requirements to achieve product protection in addition to personnel and environmental protection.

Airlocks and high/low-risk rooms (i.e., biologicals vs. cleanrooms) The design must address biosafety concerns as well as applicable GxP requirements to achieve personnel, environment, and product protection, if required.

Surfaces Floor, wall and ceiling, door and window, and other exposed component surfaces must be impervious and easy to clean. The materials must be resistant to a host of chemicals including liquid and gaseous disinfectants, if needed, for decontamination or prevention of cross-contamination. Construction attributes of floor strength, ceiling height, segregation need, piping (i.e., materials, product, and waste) and energy lines must support and promote large-scale processes.

HVAC system, room pressure, and airflow The design of the airflow must provide personnel and environmental protection. In the event a process area must be positive-pressure, consider designing the room airlock or changing area as a pressure sink. Exhaust air filtering systems may be required, as in the case of vaccine plants producing live attenuated vaccines, to prevent ductwork contamination. GxP requirements may also require product protection design considerations.

Gaseous Decontamination The HVAC system, walls, and wall penetrations must be made such that the room can be decontaminated without a negative impact to adjacent spaces. The decontaminant employed must be appropriate for the

process and biological agents handled. Use the same principles for gaseous decontamination of a laboratory, but the quantities used and the clearing times will differ substantially.

Spill Containment When designing for spill containment, consider the biological, chemical, and physical processes in an area. Always review spill scenarios while designing a facility. Identify what and how much can be released, where spilled materials will flow (e.g., are there drains leading to an effluent decontamination system (EDS) or will materials released be captured within a containment dike), if manual inactivation will be required, and what emergency response activities will encompass.

Kill Tanks/EDS Systems Ensure EDS systems can inactivate effluent from production waste and spills. It is particularly beneficial to have a facility designed with secondary failsafe systems when large amounts of material are processed. The exact method used will depend on local regulations and the materials in question. Numerous options exist, including chemical inactivation using acids or caustics, and heat inactivation (batch or continuous). Ensure holding tanks have stirrers when volumes are large. Most facilities employ hard piping, and a process to clean and decontaminate these lines between production areas and the EDS must be integrated into the plan.

Those performing risk assessments for large-scale work will also determine the type of equipment to be used by considering production needs and risk assessment results.⁶ Historically, the standard has been fixed equipment (i.e., stainless steel bioreactors) with a combination of hard and flexible hose piping for upstream (i.e., biological agent propagation) and downstream (i.e., biological agent purification, concentration, and potentially inactivation) processes. Increasingly, single-use (SU) equipment is replacing fixed equipment for upstream processes. The “ballroom” concept, where both upstream and downstream processes are in one large production facility, is now accepted for select biological processes.⁷ The ballroom concept relies on maintaining closed systems at all times.

1. **Ballroom Layout Advantages**
 - a. More flexibility to accommodate different process trains;
 - b. Improved operational efficiency and oversight (e.g., avoids having to move equipment between rooms); and
 - c. Reduction of footprints and cost.
2. **Ballroom Layout Disadvantages**
 - a. Increased risk of contamination spread in upset conditions to downstream processes;
 - b. Need for typically open operations (e.g., cell expansion, column packing or powder addition) to be handled in closed systems;

- c. Need for enhanced environmental monitoring to be conducted to detect a breach in any closed system and need to ensure contamination or cross-contamination has not occurred; and
- d. Challenging area and equipment decontamination when production areas are shared.

A non-comprehensive list of containment requirements and associated risk points is provided below to assist in the assessment of risks associated with SU equipment.

Containment Requirements and Example Risk Points⁷⁻¹⁰

1. Viable organisms should be handled in a closed system or other primary containment.
 - a. Ensure the bioreactor bag is compatible with maximum output temperature of heating control circuit;
 - b. Ensure the tubing is compatible with process media, including pH control solutions and stability testing has been performed; and
 - c. Implement procedures to ensure that probes are not removed during operation.
2. Culture fluids are not removed from a system until organisms are inactivated.
 - a. Implement procedures for removing bioreactor bag(s) containing infectious agent(s).
3. Inactivation of waste solutions and materials with respect to their biohazard potential.
 - a. Implement procedures for processing used bioreactor bags containing infectious agents;
 - b. Ensure presence of biosafety cabinet for removing reusable components before destruction;
 - c. Ensure the waste disposal procedure compatible with bioreactor bags;
 - d. Implement a procedure for safely autoclaving used bag;
 - e. Implement a procedure for safe packing and transport to incinerator if the used bag will be directly incinerated; and
 - f. Ensure the incinerator facility can burn large quantities of silicone tubing and bag film.
4. Control of aerosols by engineering or procedural controls to prevent or minimize release of organisms.
 - a. Implement controls to prevent bioreactor bag overfilling during additions;
 - b. Ensure proper procedure for tubing welding;
 - c. Ensure proper procedure for tube weld integrity test;

- d. Ensure regular PM of tubing welders to prevent misalignment; and
 - e. Ensure that plastic quick connectors (non-steamable) release viable organism(s) when released.
5. Treatment of exhaust gases from a closed system to minimize or prevent release of viable organisms.
- a. Consider exhaust gas filtration;
 - b. Consider controls of exhaust filter clogging with foam and humidity; and
 - c. Ensure there is an exhaust filter holder positioned to encourage condensate drainage.
6. Closed system that has contained viable organisms not opened until sterilized by a validated procedure.
- a. Ensure the bioreactor bag is compatible with inactivation chemical.
7. Closed system to be maintained at as low a pressure as possible to maintain integrity of containment features.
- a. Implement a process safety management study of gas overlay and sparging system to determine susceptibility to overpressure, including post-power failure;
 - b. Ensure bag installation procedures to prevent damage;
 - c. Ensure pressure control to limit aeration and overlay pressure;
 - d. Ensure the pressure alarms are interlocked to the gas supply;
 - e. Ensure pressure relief devices are installed on gas supplies and properly sized;
 - f. Consider installing in-line pressure relief before the bioreactor to protect against gas regulator failure; and
 - g. Ensure the gas supply valves fail closed upon power interruption.
8. Rotating seals and other penetrations into closed system designed to prevent or minimize leakage.
- a. Consider magnetic couplings to eliminate rotary seals;
 - b. Implement procedures to ensure stirrer operates during pre-use integrity test;
 - c. Ensure rotary seals engineered to prevent infectious agent release; and
 - d. Consider that over-speed may result in decoupling and in-bag rupture.
9. Closed system shall incorporate monitoring or sensing devices to monitor the integrity of containment.
- a. Consider bioreactor bag pressure logging;
 - b. Ensure that loss of pressure (low-pressure alarm) results in sparge/overlay shutdown; and

- c. Ensure that the sensors respond quickly enough to pressure changes.
10. Validated integrity testing of the closed containment system.
 - a. Consider integrity test procedures pre-inoculation.
 11. Emergency plans required for handling large losses of cultures.
 - a. Implement a leak detection system for bottom- or side-mounted probes;
 - b. Consider bottom- or side-mounted sensors guarded to prevent impact damage;
 - c. Consider respiratory PPE as part of operating PPE or ensure respiratory PPE availability for emergency cleanup;
 - d. Ensure a contaminated worker emergency procedure available;
 - e. Ensure a large spill clean-up procedure available, including a spill kit;
 - f. Ensure personnel trained in large-scale clean-up of infectious organisms; and
 - g. Consider gas decontamination of production suite post-incident.
 12. Requirements for controlled access area.
 - a. Ensure aerosol-containment within skid (i.e., process module);
 - b. Consider a spill containment pan to contain or divert entire bioreactor contents for inactivation;
 - c. Ensure the pan will divert a worst-case leak scenario to biowaste without spill to the floor;
 - d. Consider spill containment within the suite (dike, bund, raised door threshold) to contain entire bioreactor contents for inactivation;
 - e. Ensure the suite exhaust HEPA filtration for fluid transfers outside bioreactor containment; and
 - f. Ensure the suite is designed to prevent the release of infectious aerosols using differential pressure and sealing of room penetrations.

Those performing risk assessments for large-scale work will also need to review equipment types and assist in the evaluation of the choice that will best balance the needs of GxP and biosafety. These equipment types include:

Pumps and Pipes The type of piping used will depend on how the process is laid out. Hard piping will need clean-in-place (CIP) and sterilization-in-place (SIP) for both GxP and biosafety reasons. Soft hoses allow for quick changes and cleaning. The type of pump will have to meet the volume demands of production. Peristaltic pumps are often used in combination with soft hoses. The risk assessment must show what type of piping and pump to use to meet

GxP (if applicable), biosafety, and general HSE demands. Make sure that points where pipes penetrate walls are correctly sealed to promote safe gaseous decontamination. Additionally, pump operation should be evaluated for hearing protection implementation.

Compressed Air and Gases Compressed air is one means of transferring fluids between vessels. The safety review will identify elevated pressure points, type of relief valve protection required, and rupture disc failure scenarios. Some processes require asphyxiants, such as CO₂ or N₂, and safety measures are to be established to mitigate associated risk.

Electrical Power Power should be installed in a manner that prevents water ingress in all production and failure modes. Planning and construction must follow local electrical codes and the Occupational Safety and Health Administration electrical standards. Large fixed equipment fermenters and equipment often require high voltage power, which creates the need for additional safety measures including emergency stop buttons to shut down equipment and installation of water and dustproof electrical enclosures.^{11,12} Special care must be taken when solvents are used in production; follow applicable national codes, such as NFPA, UL, and OSHA. UPS needs must be evaluated based on the equipment and facility needs. An emergency generator may be essential to maintain biocontainment.

Production equipment including bioreactors, fermentors, filtration units and centrifuges In all upstream and some downstream processes, equipment is used while the product is still infectious. These units must be set up to eliminate the risk of aerosol release. Prior to charging process equipment with live biological material, the integrity of the closed system should be verified. Before opening a closed system for maintenance or cleaning, in situ decontamination of the vessel is required. To prevent an aerosol release occurring as a result of an upset condition, small equipment can be placed inside a containment device such as a biological safety cabinet. Larger equipment containing infectious agents should reside in rooms under negative pressure. If negative pressure can't be achieved, room entry and exit airlocks may be used as negative air pressure "sinks" to prevent the escape of aerosols into adjacent areas.

Work Practice and Administrative Controls

Good microbiological practices are vital and apply in the same way as they do in biological research laboratories. Chemical hygiene, hearing protection evaluations in equipment areas, ergonomic, and safety principles apply to large-scale biological production areas as they do in other research laboratories and production areas. Access should be restricted to trained personnel only. Other administrative controls include:

Occupational Health Employers should offer workers appropriate medical surveillance programs to identify immune suppression and other underlying medical conditions, which could be risk factors that necessitate adaptations or accommodations. Occupational physicians should advise on, from a medical point of view, protection measures and procedures (e.g., fitness for duty to wear respirators or perform specific tasks). Where appropriate, the physician will offer vaccination, or provide vaccines, with follow up on titers. In addition to surveillance, clinical treatment procedures for accidental exposure should be developed. For biological agents susceptible to antibiotics, antimicrobial susceptibility testing results should be obtained before large-scale operations begin.

Emergency Response Plans for different emergency situations should be established, including spill protocols. Where appropriate, post-exposure prophylaxis and policies for isolation of potentially infected people should be established. One differentiating factor between small and large spill clean-up is that, unless there is an immediately dangerous for life and health (IDLH) situation, the operator in a large-scale facility must remain in the room long enough to stop and contain the release to minimize HSE consequences. Further information on emergency preparedness and response can be found in *Biological Safety: Principles and Practices*.¹³

Laboratory Biosecurity The risk management strategy for a large-scale risk assessment should define both a biosafety containment strategy (refer to [BMBL Section II](#), NIH Guidelines' Appendix K, and the area-specific risk assessment) and a laboratory biosecurity strategy. The biosafety containment strategy defines controls that mitigate risk from an unintentional release, and the laboratory biosecurity strategy defines controls that prevent theft of biological agents that are associated with human health and/or agricultural industry impact. Likewise, materials, equipment, technology, and knowledge of dual-use potential needs to be addressed and a strategy developed to address misuse.¹⁴⁻¹⁸

Training Biosafety, laboratory biosecurity, and GxP training (if applicable) are essential in large-scale biological production. For large-scale processes, training should review the epidemiology, signs/symptoms of infection, mode of transmission, risk-mitigating controls including donning and doffing of PPE, and emergency response procedures, area-specific SOPs, including spill response protocols, required for the biological agent/material handled. Workers should understand when PPE is required for product protection vs. personnel protection. An understanding of the handling requirements for inactivated vs. unconfirmed inactivated materials is critical. Training should include a knowledge check.

Ergonomics The ergonomic issues associated with large-scale operations differ from those encountered in the laboratory. Material handling in large-scale operations will present a larger risk of ergonomic injury. To address the ergonomic issues associated with material handling, include the nature of the load in the risk

assessment (i.e., the weight distribution and shape of the load), the capabilities of the individual performing the task, the duration and frequency of the task, and the environment in which the material handling task is performed (e.g., space limited or extreme temperature environments). Mitigate ergonomic risks by mechanical means (e.g., lifts, hand trucks, pushcarts), redesign of the work area (e.g., ramps to replace stairs, automated transfer of materials to replace manual transfer), redesign of the work task (e.g., pushing rather than pulling), and training of personnel (e.g., proper lifting technique).

Waste Handling The processes of waste handling are the same as for research laboratories but larger amounts require different logistics. For guidance on validation of decontamination agents and procedures, refer to [Appendix B](#). Key considerations include inactivation of organisms in situ vs. external to process vessel or container. Consider inactivation methodologies for solid infectious waste streams as well as wastewater from production effluent (i.e., determine if there will be an impact to the site wastewater treatment permit due to the presence of organics including preservatives such as thimerosal or adjuvants).

Review and Checking of Risk Control Measures Risk control measures need to be evaluated for efficacy in order to protect people and the environment. The organization should maintain a risk control register, which should be periodically reviewed. The strategy should address the major risk streams (e.g., chemical, physical, biological, and ergonomic).

Preventative Maintenance Preventative maintenance is vital to avoiding process contamination and to ensuring biocontainment. Safety and security-related equipment and infrastructure should be incorporated into a preventive maintenance program that incorporates a change control process. For example, rotary seals in fermenters must be monitored for increased loss of seal water or steam pressure and should be replaced before failure; high-pressure piston seals of homogenizers must be replaced regularly to prevent aerosol release; autoclave temperature and pressure sensors require regular calibration, and steam traps must be maintained. Depending on design, autoclave bioseal or air differential seals should be tested (e.g., smoke, pressure hold, soap bubble, and helium leak testing) to determine whether they have deteriorated. When required, HEPA filters (i.e., HVAC and equipment) should be integrity tested annually and critical barrier HEPAs should be monitored for pressure differential. Thermal or chemical inactivation systems should undergo regular inspection for corrosion and preventative maintenance of gaskets, seals, and sensors, as well as addition pumps, to ensure proper operation. Validation of inactivation parameters is also required by using spore-based indicators or the actual production organisms. Continuous flow thermal inactivation systems should undergo regular chemical clean-in-place cycles to remove coagulated protein residues, which can reduce system efficiency.

PPE/Gowning

PPE and gowning are used for both personnel and product protection. When PPE is utilized for product protection, it is designed to prevent shedding of foreign material into the production process and final product and to contain skin and respiratory shedding from the worker. Standard cotton or synthetic materials are not acceptable because they are prone to shedding. When PPE is utilized for worker protection, it should be assessed against physical, chemical, and biological hazards. Cotton laboratory coats or jumpsuits are easily saturated with chemical and biological liquids during a large release or spill and do not provide adequate protection. Man-made, water-resistant polymers are a better choice; they are less apt to become saturated. Refer to the material permeation rate or breakthrough detection time. The most protective options for personnel protection are gowns made of microporous laminated materials or jumpsuits with covered zippers.

Depending on the chemicals and/or biological materials handled, large volumes at high concentration plus the inherent increased risk of aerosol generation may require respiratory protection. Common disposable, half-face respirators (e.g., N95) may be sufficient for biological material protection, but they are not designed for chemical protection and may not be sufficient to protect against large volumes of a concentrated high-risk pathogen. Therefore, a risk assessment should be performed to identify the appropriate respirator required for the operation (i.e., filtering facepiece, tight-fitting facepiece, PAPR or SCBA).

Conclusion

Large-scale growth of biological agents is necessary in a variety of settings and requires an evaluation of both the GxP and biosafety requirements. With careful planning and a robust risk assessment of the unique requirements of a large-scale facility, it is possible to design and operate a facility that protects the product, workers, and the environment.

References

1. Good Laboratory Practice for Nonclinical Laboratory Studies, 21 C.F.R. Part 58 (2018).
2. U.S. Department of Health & Human Services. Guidance for Industry: Quality Systems Approach to Pharmaceutical CGMP Regulations. Food and Drug Administration; 2006. 32 p.
3. McGarrity GJ, Hoerner CL. Biological Safety in the Biotechnology Industry. In: Fleming DO, Richardson JH, Tulis JH, Vesley D, editors. Laboratory Safety: Principles and Practices. 2nd ed. Washington (DC): ASM Press; 1995. p. 119–31.

4. Center for Chemical Process Safety of the American Institute of Chemical Engineers. Guidelines for Process Safety in Bioprocess Manufacturing Facilities. Hoboken (NJ): John Wiley & Sons, Inc.; 2011.
5. Hambleton P, Melling J, Salusbury TT, editors. Biosafety in Industrial Biotechnology. Glasgow: Springer Science+Business Media Dordrecht; 1994.
6. Cipriano ML, Downing M, Petuch B. Biosafety Considerations for Large-Scale Processes. In: Wooley DP, Byers KB, editors. Biological Safety: Principles and Practices. 5th ed. Washington (DC): ASM Press; 2017. p. 597–617.
7. Palberg T, Johnson J, Probst S, Gil P, Rogalewicz J, Kennedy M, et.al. Challenging the Cleanroom Paradigm for Biopharmaceutical Manufacturing of Bulk Drug Substance. *BioPharm International*. 2011;24(8):1–13.
8. Klutz S, Magnus J, Lobedann M, Schwan P, Maiser B, Niklas J, et al. Developing the biofacility of the future based on continuous processing and single-use technology. *J Biotechnol*. 2015;213:120–30.
9. Löffelholz C, Kaiser SC, Kraume M, Eibl R, Eibl D. Dynamic Single-Use Bioreactors Used in Modern Liter- and m(3)- Scale Biotechnological Processes: Engineering Characteristics and Scaling Up. *Adv Biochem Eng Biotechnol*. 2014;138:1–44.
10. Halkjaer-Knudsen V. Single-Use: The fully closed systems?. *Am Pharma Rev*. 2011;14:68–74.
11. Occupational Safety and Health Administration. Controlling Electrical Hazards. Washington (DC): U.S. Department of Labor; 2002.
12. National Fire Protection Association. Standard for Electrical Safety in the Workplace. NFPA 70E. 2018.
13. Wooley DP, Byers KB. Biological Safety: Principles and Practices. 5th ed. Washington (DC): ASM Press; 2017.
14. National Institutes of Health [Internet]. Bethesda: Office of Science Policy; c2018 [cited 2018 Nov 27]. Dual Use Research of Concern. Available from: <https://osp.od.nih.gov/biotechnology/dual-use-research-of-concern/>
15. Science Safety Security [Internet]. Washington (DC): U.S. Department of Health & Human Services; c2015 [cited 2018 Nov 27]. United States Government Policy for Institutional Oversight of Life Sciences DURC. Available from: <https://www.phe.gov/s3/dualuse/Pages/InstitutionalOversight.aspx>
16. Science Safety Security [Internet]. Washington (DC): U.S. Department of Health & Human Services; c2017 [cited 2017 Nov 27]. Dual Use Research of Concern. Available from: <https://www.phe.gov/s3/dualuse/Pages/default.aspx>

17. Drew TW, Mueller-Doblies UU. Dual use issues in research—A subject of increasing concern?. *Vaccine*. 2017;35(44):5990–4.
18. Sandia National Laboratories. Laboratory Biosafety and Biosecurity Risk Assessment Technical Guidance Document: International Biological Threat Reduction. Albuquerque and Livemore: Sandia Corporation; 2014.

Appendix N—Clinical Laboratories

Clinical Laboratory Biosafety

Most contemporary medical decision-making utilizes the result(s) of at least one diagnostic test conducted in a clinical laboratory as a part of evidence-based care.^{1,2} Clinical laboratories are one of the first lines of public health defense because they detect and report epidemiologically important organisms and identify emerging patterns of antimicrobial resistance. The safe, effective operation of clinical laboratories is critical for both the care of individual patients and the health of laboratory professionals, the community, and the environment.

In 2016, following the U.S. Ebola crisis, the U.S. Clinical Laboratory Improvement Advisory Committee (CLIAC) recognized “the matter of biosafety in clinical laboratories as an urgent unmet national need.” In particular, CLIAC indicated the need for concise, understandable guidance to help enable clinical laboratories to assess and mitigate risks when the identity of the infectious agent is unknown or unconfirmed.³ This appendix focuses on biorisk management (BRM) in a clinical laboratory environment and includes considerations to effectively assess and mitigate risks and evaluate the performance of the implemented controls in reducing risks associated with the handling, storage, and disposal of hazardous biological materials.⁴

Conducting Risk Assessments in a Clinical Laboratory Environment

Risk assessment is the process of evaluating the risk(s) that arise from agent and laboratory hazards, taking into account the adequacy of existing controls, prioritizing those risks, and deciding if the risks are acceptable.⁵ The risk assessment generates information that guides the selection of appropriate microbiological practices, safety equipment, and facility safeguards that can reduce Laboratory-associated infections (LAIs). In addition, the integration of the risk assessment process into daily laboratory operations results in the ongoing identification and prioritization of risks and the establishment of risk mitigation protocols tailored to specific situations; this promotes a positive culture of safety.⁶ Please refer to [Section II](#) for additional information.

Risk assessment is the foundation of every comprehensive BRM system. The BRM approach is similar to the Quality Management System (QMS) or Individualized Quality Control Plan (IQCP) that clinical laboratories commonly use to establish quality standards for laboratory testing. QMS and IQCP include processes for risk assessment, quality control planning, and quality assessment.⁷ BRM includes processes for risk assessment, risk mitigation and performance evaluation of implemented controls to reduce risks; this has become known as the Assessment Mitigation Performance (AMP) model.⁴ Ideally, BRM and QMS should be integrated and mutually supportive systems in a clinical laboratory.

The clinical laboratory director is responsible for the overall operation and administration of the laboratory. As stated in the Clinical Laboratory Improvement Amendments (CLIA) regulations,⁸ the laboratory director must:

1. Ensure that testing systems developed and used for each of the tests performed in the laboratory provide quality laboratory services for all aspects of test performance, and
2. Ensure that the physical plant and environmental conditions of the laboratory are appropriate for the testing performed and provide a safe environment in which employees are protected from physical, chemical, and biological hazards.

However, the responsibility for ensuring the safe and secure handling of hazardous materials in a clinical laboratory should be shared. Laboratory leadership should not conduct risk assessments alone, but should depend on the knowledge and expertise of the laboratory, infection prevention, and safety professionals; a multidisciplinary team should be responsible for the laboratory's risk assessments. Risk assessments should be documented and routinely evaluated, particularly when new instruments, tests, staff, or processes have been added to the laboratory environment. Additionally, risk assessments should be evaluated when unanticipated or unusual events, near-misses, incidents, or accidents occur. Implementation of a continual risk assessment process creates a proactive approach to laboratory safety rather than a reactive one, potentially preventing incidents and accidents before they happen.

The assessment team should determine what hazards may exist and the risks associated with those hazards. When the agent hazards are unknown, it may be helpful for clinical laboratories to monitor current disease outbreaks and compile lists of commonly encountered pathogens for a population, region, or specimen type. Knowledge of endemic diseases in an area and receipt of a specimen type may suggest the presence of specific infectious agents. For instance, a blood specimen from a patient with recurring fevers who has recently returned from travel in central Africa may suggest the presence of the protozoan parasite, *Plasmodium falciparum*, a causative agent of malaria. In addition, clinical laboratories can sometimes gain insight into a suspected diagnosis, or even a pathogen, based on the tests that physicians order. For example, an order for an acid-fast stain on a sputum specimen could suggest mycobacteria such as *Mycobacterium tuberculosis*, the causative agent of tuberculosis. As a best practice, clinical laboratories should encourage clinicians to notify the laboratory when they suspect a patient(s) may have an infectious disease that could pose risks to the laboratory professional.

To help structure biological risk assessments, clinical laboratories should consider what procedures or activities will be performed, where the work will be performed, who will perform the work, and what undesirable events could

occur. It is also essential to evaluate the potential routes of transmission of the suspected infectious agent (i.e., inhalation of aerosols, ingestion, percutaneous inoculation from sharps or non-intact skin, and direct mucous membrane contact from splashes or droplets). In general, blood and body fluids are not normally an inhalation risk, but there is a risk of percutaneous, mucous membrane contact, ingestion, or non-intact skin exposure in clinical laboratories. Protecting portals of entry (i.e., eyes, nose, mouth, and non-intact skin) can reduce initial exposure to hazards, subsequent transmission of infectious agents, and potential LAIs. The use of laboratory equipment, including instruments for analytical testing, may also present safety risks. A recent study showed that during routine operation of automated clinical laboratory equipment, potentially infectious aerosols or microdroplets were recovered from laboratory equipment surfaces and surrounding workspaces; this finding presents an exposure hazard for laboratory professionals.⁹

Clinical laboratories should consider a wide range of potential hazards when conducting a risk assessment. Examples of hazards unique to the clinical laboratory that should also be considered are listed below:

- Hazards associated with unknown specimens;
- Hazards associated with point-of-care (POC) and/or bedside testing; and
- Hazards associated with inadequate mitigation capabilities.

Implementing Mitigation Measures in the Clinical Laboratory Environment

There are specific safety requirements for clinical laboratories. The Occupational Safety and Health Administration's (OSHA's) Bloodborne Pathogens (BBP) Standard¹⁰ must be followed when clinical laboratories handle blood and body fluids. As part of the BBP Standard, the laboratory must have a written Exposure Control Plan (ECP) that addresses the identification, evaluation, and selection of effective engineering and work practice controls to eliminate or minimize employee exposure. Standard Precautions are an expansion of the major features of Universal Precautions (UP) that are outlined in the BBP Standard; they are based on the principle that all blood, body fluids, secretions, excretions (except sweat), non-intact skin, and mucous membranes may contain transmissible infectious agents, regardless of the suspected or confirmed presence of an infectious agent.¹¹ Implementation of Standard Precautions constitutes the primary strategy for the prevention of transmission of infectious agents among healthcare personnel,¹¹ with additional controls implemented as indicated by the risk assessment.¹²

In general, clinical laboratories conduct the majority of their work at BSL-2, including initial processing of clinical specimens for microbiology workup in a biosafety cabinet (BSC); see [Section IV](#) for additional information. Traditionally, the safety community has relied on a hierarchy of controls to select measures to

eliminate or minimize exposure to hazards and their associated risks,¹³ and the most effective biosafety systems include controls from across this hierarchy. In order of decreasing effectiveness, the control methods are:

- Elimination;
- Substitution;
- Engineering controls;
- Administrative (and work practice) controls; and
- Personal Protective Equipment (PPE).

Infection control and biosafety issues that are identified in the course of outbreak investigations often indicate the need for new recommendations or the implementation of existing recommendations for high-risk pathogens. In a scenario in which a clinical laboratory may be in possession of a specimen for which the facility is unable to provide the appropriate mitigation, it may be advisable to consider shipping the specimen to a facility with the equipment and experience to handle the clinical specimens.

The following risk mitigation measures apply in the scenario where the clinical laboratory can effectively implement appropriate risk mitigation.

Elimination and Substitution Elimination and substitution are concepts that are more readily applied to a research environment than a clinical setting. In a clinical laboratory, elimination might mean foregoing a diagnostic test in a case because the risks are considered too high, or the existing mitigation measures are considered inadequate. Substituting the agent hazard for something less hazardous also does not apply in a clinical laboratory environment; in some cases, substituting diagnostic equipment, instrumentation, or procedures may not be desirable. In these situations, clinical laboratories rely on a combination of additional engineering controls, administrative and work practice controls, and PPE for their safety mitigation measures. Risk assessments should be used to customize that combination in the most effective way for the specific work of that laboratory.

Engineering Controls Engineering controls can reduce hazardous conditions or place a barrier between the laboratory professional and the hazard. Barriers commonly used are Class II BSCs, sharps containers, centrifuge safety cups, removable rotors, splash shields, directional inward airflow into the laboratory, closed automation systems, automated decappers or cap-piercing test systems, and handwashing sinks. When specific engineering controls are not possible, one option may be to include alternative containment devices such as an enclosed workstation in combination with additional work practices and/or enhanced PPE.

Administrative and Work Practice Controls Administrative and work practice controls target changes in work procedures that promote safe behaviors of laboratory staff. Administrative controls include implementing institutional policies, such as establishing an active medical surveillance program and occupational health program, and providing immunizations for infectious agents that are commonly encountered by laboratory professionals (e.g., hepatitis B and *N. meningitidis*). Other examples include written standard operating procedures (SOPs), laboratory signage, and professional training programs. Work practice controls involve the performance of tasks and adherence to standard and special practices. Some examples are mandating frequent handwashing, minimizing the generation of aerosols, limiting the use of sharps, using safer sharps (e.g., self-sheathing needles and needleless systems), routinely decontaminating work areas and equipment, safely collecting and decontaminating liquid waste from automated systems, disposing of biohazardous and other hazardous waste properly, and working appropriately inside a BSC. Risks are unlikely to be effectively mitigated unless staff understand, use, and adhere to the engineering and administrative controls and work practices.

The importance of administrative and work practice controls is well-illustrated through the response to the 2014–2016 Ebola outbreak. In 2014, when a community hospital in Texas treated the first Ebola patient diagnosed in the United States, the hospital lacked a dedicated and specialized biocontainment unit to conduct diagnostic tests on specimens from the patient. Laboratory management assessed the risks and implemented additional administrative and work practice controls in their core laboratory to ensure the safety of their laboratory professionals while conducting diagnostic tests for their patients. As a result, the clinical laboratory professionals successfully handled patient specimens with no LAIs in any clinical laboratory staff.¹⁴ Some examples of specific controls used in Texas during the Ebola outbreak included:

- Limiting the number of staff who conducted diagnostic testing;
- Abbreviating test menus (limiting the types of tests that were ordered);
- Restricting the testing to a specific time of day and implementing batch testing (collecting and running the tests at the same time); and
- Conducting diagnostic testing in a dedicated space within the core laboratory with dedicated equipment.

Trigger Points Another practice becoming more common in clinical microbiology laboratories is the recognition of *trigger points* during diagnostic testing that prompt workers to conduct work in a BSC^{12,15,16,17} or other containment device. A trigger point is a recognized combination of diagnostic findings that can be used to determine when to heighten the precautions or conditions for handling a specimen or culture.

The following list, which is not comprehensive, includes some examples of trigger points for continuing further workup in a BSC:

- Growth from sterile sites (e.g., blood, cerebrospinal fluid [CSF], body fluid);
- Poor growth after 48–72 hours incubation;
- Growth only on chocolate agar or better growth on chocolate agar compared to sheep blood agar (SBA); and/or
- Any culture with filamentous mold growth.
- Other organism-specific trigger points include:
- Slowly growing colonies on SBA from sterile sites (e.g., blood or CSF), no growth on MacConkey agar, oxidase-positive, and Gram stain showing small Gram-negative diplococci. Possible microorganism: *Neisseria meningitidis*.
- Rapid growth of flat, nonpigmented, irregular colonies with comma projections and ground-glass appearance, and Gram stain showing boxcar-shaped, large Gram-positive rods with or without spores. Possible microorganism: *Bacillus anthracis*.
- Gram-negative rod (GNR) with bipolar staining (safety pin shape) and “fried egg” appearance in older cultures. Possible microorganism: *Yersinia pestis*.

It is not recommended to use commercial identification systems (i.e., manual or automated, including matrix-assisted laser desorption/ionization-time of flight mass spectrometry (MALDI-TOF) and Vitek®) for the identification of suspected Select Agents. There is no requirement that commercial test systems contain Select Agents in their databases nor are they required to test Select Agents to verify potential misidentifications. In addition, there is a risk of generating aerosols during operation of MALDI-TOF.⁹

Personal Protective Equipment (PPE) reduces exposure by blocking the clinical laboratorian’s portals of entry (i.e., the eyes, nose, mouth, and skin). If known, the route of transmission of an infectious agent can help the risk assessment process determine what PPE is appropriate. Many pathogens are transmitted by multiple routes (e.g., routes for influenza can be droplet, contact, or possibly airborne), and applying precautions for only one route of transmission is not sufficient. Depending on the risk assessment, respiratory protection could be used when working with an infectious agent that is known or suspected to be airborne transmissible. Working with an infectious agent that is known to be transmissible by blood may warrant protection of a person’s mucous membranes (i.e., eyes, nose, and mouth).

Risk assessments assist with determining what PPE should be worn for specific work in the clinical laboratory. In general, clinical laboratories use closed laboratory coat or gown, eye protection, closed-toe shoes, and gloves.

Risk assessments should differentiate between routine laboratory testing and uncommon activities, such as testing for high-consequence pathogens; thus, risk assessment may determine different PPE should be used to mitigate different risks. Increasing the amount or use of PPE does not always indicate an increase in safety; PPE should be carefully selected to provide the appropriate level of protection needed without compromising the health of the laboratory professional or their ability to safely perform their duties. The National Institute for Occupational Safety and Health and OSHA each have additional information on PPE selection and use.^{18,19} See [Section IV](#) for additional information on PPE.

Worker Competencies and Training

Creation of a culture of safety and a safe work environment depends on conscientious and effective leadership. Laboratory professionals must receive information, resources, and training, and have sufficient time to build good habits that make them risk-conscious and attentive to safety practices. Laboratory safety competencies may include: understanding the hazards in the laboratory and the risks associated with specific activities; knowledge of the procedures for using specific control measures (e.g., BSCs, PPE, safer sharps) and their limitations; ability to help evaluate the effectiveness of those procedures and control measures; and demonstrated commitment to work safely with biological materials in the laboratory. The quality of laboratory testing has been an expectation of clinical laboratory accreditation and licensure agencies for many years, and some agencies are now moving toward inclusion of laboratory safety as another required competency for accreditation.

Training and practice on the use of PPE are critical for safe operations in the clinical laboratory. If not used properly, the PPE will likely not achieve its intended outcome. Laboratory professionals should routinely practice donning, doffing, and wearing specific PPE while conducting laboratory tasks in order to determine their level of comfort and physical ability to perform those tasks.

Laboratory professionals should also be competent in decontamination of the laboratory for routine cleaning, disposing of waste, and responding to spills. They should understand the types and volumes of spills that they can safely handle, and which require additional support. They should be trained on non-routine and emergency operations, including worker-specific responsibilities. It is difficult to predict how people will respond during non-routine or emergency situations, but frequent training and drills will help identify gaps that were not recognized previously and facilitate the revision of procedures.

A positive and proactive culture of safety can be reinforced by including safety expectations in job descriptions, reviews of employee performance, and career advancement.²⁰ Supervisors should ensure that all laboratory professionals:

1. Understand the risks involved with their work and how to use the safety controls implemented to reduce risks;
2. Complete required training and refresher training as appropriate;
3. Demonstrate appropriate technical expertise to safely and accurately complete their duties; and
4. Recognize the limitations of implemented controls and what to do if they are ineffective.

Emergency Response Procedures

Working in a clinical laboratory environment will always involve some level of risk, and unintended events, including incidents and accidents, will occur. Therefore, laboratories should have mitigation procedures outlined in an emergency response plan to address those unintended events. This plan should cover both events that could occur in the laboratory and events that could occur outside the laboratory environment but directly impact laboratory operations. The clinical laboratory emergency response plan should be based on a site-specific comprehensive risk assessment that allows management to prioritize the laboratory's response procedures according to the determined level of risk.

Examples of emergencies that could occur in the laboratory include spills inside and outside of primary containment (e.g., BSC), exposure to hazardous materials (e.g., infectious agents, chemicals), medical emergencies, small fires, and water leaks. Examples of emergencies that could occur outside of the laboratory include laboratory system failures (e.g., loss of power, loss of directional airflow), building emergencies, and natural disasters.

Depending on the laboratory emergency, different members of the community may need to be involved in the risk assessment and the development of the laboratory emergency response plan. For example, responding to a fire may require collaboration with first responders (e.g., firefighters) and responding to exposure to a hazardous material may require coordination with infectious disease specialists outside of the institution.

Laboratory management should ensure that an emergency response plan exists, that it has been communicated to staff, that they have been trained on the plan, and that staff are capable of executing the specific procedures detailed in the plan. In addition, hazard communication in the form of signage and posted SOPs can assist staff during an unexpected event.

Considerations for emergency response may include, but are not limited to, training, including drills, specific procedures for incidents, continuity of operations plans, surge capacity, and logistical and mental health support for staff.

Discussion-based exercises (i.e., tabletop exercises) and operations-based drills (i.e., live drills) should be conducted routinely to test the effectiveness of

the emergency response plan. These drills and exercises should include diverse groups who would be involved in laboratory emergency response, including institutional leadership, laboratory leadership, laboratory professionals, operations and maintenance workers, first responders, and other involved parties. The results of the drills and exercises should be documented, evaluated for successes as well as opportunities for improvement, and the findings and observations of the drills and exercises should be used to revise laboratory risk assessments, as well as the laboratory emergency response plan.

Challenges in a Clinical Laboratory Environment

Clinical laboratory operations differ from those of academic (i.e., teaching) and research laboratories. The workflow in a clinical laboratory typically encompasses three phases of testing: pre-analytical, analytical, and post-analytical. Briefly, the pre-analytical phase occurs prior to the specimen being tested in the laboratory or at the point-of-care (POC). During this phase, specimens are collected, labeled, packaged, and transported or shipped. The analytical phase encompasses diagnostic testing. The specimen is prepared for specific tests, analyzed, and the result(s) verified. The post-analytical phase involves the reporting of diagnostic test results, the storage of specimens, and the disposal processes.

Handling Specimens with Unknown Pathogens

Diagnostic testing for a single patient may involve receipt of multiple types of specimens (e.g. blood, sputum, urine) with little information regarding suspected diagnoses. Clinicians assess the patient and often order a battery of diagnostic tests. These tests can encompass a wide range of possible diagnoses; tests may include metabolic panels and blood counts that do not target specific pathogens. Furthermore, initial testing may not result in a definitive diagnosis, particularly for uncommon pathogens. When atypical pathogens are under consideration for diagnosis, appropriate differential testing is not always initially ordered. Laboratory professionals, which include phlebotomists, are often not aware of the hazards and subsequent risks posed by the specimens they draw or handle until testing has been completed and a diagnosis confirmed.

The risks associated with handling clinical specimens may not be fully recognized. Some pathogens have low infectious doses and some clinical specimens have high pathogen loads based on the stage of the patient's infection. Additionally, multiple pathogens may be present in one clinical specimen. In clinical microbiology laboratories, clinical microbiologists isolate, grow, and expand populations of the pathogen(s) to obtain a pure culture for performing identification and antimicrobial susceptibility tests. Culturing increases the manipulations and quantities of the pathogen(s), thereby increasing the risk for microbiologists who handle those organisms.

Diagnostic Testing Environments

Diagnostic testing incorporates many disciplines and is generally performed in different laboratories or sections of the laboratory (e.g., hematology, chemistry, cytology, histology, microbiology). Each of these laboratories conducts a variety of tests and utilizes various equipment/procedures. Routine laboratory procedures may generate aerosols (e.g., pipetting, mixing, centrifuging, vortexing, aliquoting, grinding, plating, and opening or removing caps).¹² Clinical laboratories conduct a high volume of tests in a fast-paced, highly technical, and repetitive testing environment. High-throughput instrumentation, such as large chemical analyzers and other automated equipment, are often operated outside of secondary containment and can potentially generate splashes, splatters, and aerosols during operation.

Most clinical and public health laboratories incorporate BSL-2 standard and special practices, safety equipment, and facility recommendations. However, because of space and workflow challenges, manipulation of specimens that potentially contain pathogens may occur in an open environment, such as on a laboratory benchtop. Consequently, mitigation strategies and controls must be implemented to reduce the risk of exposure to laboratory professionals. Please also see [Section IV](#) for additional information on BSL-2.

Point-of-care or bedside testing is performed with increasing frequency and in non-traditional laboratory testing environments; implementing engineering controls may be difficult in this setting. Likewise, nurses, respiratory therapists, and medical assistants who do not routinely collect specimens or perform laboratory analyses may be tasked with conducting these tests at the bedside to provide immediate data for patient care. This practice occurs in critical care units, physician offices, health fairs, emergency departments, and ambulances. Since these environments frequently lack the engineering controls of a properly designed laboratory facility, additional procedural controls and PPE are used.

Clinical Laboratory Workforce

In contrast to research or academic settings, most clinical laboratories operate 24 hours per day, 7 days per week, 365 days per year, and clinical laboratory staff often work rotating shifts or evening/night shifts to maintain critical operations. This can cause laboratory staff to become fatigued. When fatigue occurs, judgment can be impaired⁶ and existing safety measures may be overlooked. The loss of skilled professionals because of high turnover, an aging workforce, a reduction in educational and training programs, and a lack of time and resources for training can also make it difficult to maintain safety competencies across the laboratory workforce.

Laboratory-associated infections

The first reported Laboratory-associated infection was published in 1893 in France when an accidental inoculation resulted in a tetanus infection.²¹ Despite the evolution of biosafety practices and equipment, laboratory exposures to infectious agents and LAIs continue to occur. One recent American Society for Microbiology (ASM) publication summarizes LAI data collected from 1930 to 2015; the article indicates that, although the overall frequency of LAIs from the most commonly reported agents has decreased, the total number of LAIs in clinical laboratories has increased while LAIs from research laboratories has decreased during the same timeframe.²² The majority of the LAIs occurred in clinical microbiology laboratories and were bacterial infections.

Understanding the origin of these LAIs is still often elusive. It is widely accepted that the numbers of LAIs reported or documented represent a substantial underestimation of the actual number of LAIs. Undocumented cases and lack of denominator data continue to complicate the assessment of risk and determination of true LAI incidence rates. It is estimated that the definitive cause (e.g., distinguishable accident or exposure event) could not be identified in 80% of reported LAIs.^{23,24} Many of these LAIs with unrecognized exposure events are believed to be due to aerosol exposures. Sources of exposure that could be explained included spills and splashes to mucous membranes, ingestion (i.e., from contaminated surfaces or fomites to hands to mouth), and percutaneous inoculation from sharps, cuts, needlesticks, and non-intact skin.

Implementing Performance Management in a Clinical Laboratory Environment

Recent safety systems literature shows that every organization creates a culture that influences the practice and effectiveness of safety within that environment.²⁵ When incidents occur, they are almost never isolated errors committed by single individuals. Instead, incidents generally result from multiple, small errors in organizations that reflect underlying system flaws. Performance management recognizes that procedures and human behavior will always change and adapt over time and that human error is inevitable, especially in complex, high-stress environments.²⁵

Effective performance management should be planned during the risk assessment process by a cross-section of the staff who are responsible for and regularly work in the clinical laboratory. The risk assessment should not only identify and prioritize risks and select the most appropriate control measures but also establish how those control measures will be evaluated on a routine basis.²⁶ The laboratory professionals should be primarily responsible for actively monitoring and evaluating the effectiveness of the chosen control measures.

Historically, a facility's safety officer or manager conducts internal audits and inspections to verify that biosafety controls are in place. Following an accident or safety incident, the safety officer executes an analysis to identify the root causes of the accident and then implements corrective actions. However, this reactive approach to performance management is minimally effective because audits and inspections occur on a relatively infrequent basis, and thus only reflect operations at a moment in time.

Routine, proactive monitoring and evaluation will highlight daily accounts of successful safety performance. Checklists (e.g., PPE and BSC) and process maps are effective methods for achieving routine evaluation. A PPE checklist could include the specific PPE needed for that protocol, steps for checking the integrity of the PPE, steps for donning and doffing of the PPE, steps for decontaminating non-disposable, reusable PPE, and steps for discarding used PPE. A BSC checklist could include checking the certification date of the cabinet, confirming the most recent BSC training date of the users, conducting an airflow check, and performing surface disinfection.

Every laboratory should develop its own monitoring and evaluation methods. It is important for laboratory professionals to participate in measuring the effectiveness of the controls. In order to be successful, the laboratory professionals will need to understand the risks that the controls are designed to mitigate and to determine whether the controls are working as intended. One way to encourage the engagement of laboratory professionals is to incorporate a non-punitive approach for reporting operational problems and proposing solutions that improve biosafety. Discussions about recent, unanticipated events in the laboratory could result in changes in the way that risks are controlled before a safety incident occurs.

Risk Ethics in a Clinical Laboratory Environment

There will always be risks associated with working in a clinical laboratory, and risk ethics must be included in the clinical laboratory risk assessment process. Risk ethics are principles that guide rational choices on risk-taking and risk exposure. When a clinical laboratory conducts a risk assessment, numerous risk perception factors should be considered that may influence different management strategies. Some of these include individual factors (e.g., knowledge, demographics, personality, health, stress), context factors (e.g., culture, social relationships, political views, recent events, financial benefit), and other factors (e.g., cost-benefit analysis or negative media coverage).

Risk tolerance and risk aversion (or risk acceptability) will vary between and even within institutions. Each clinical laboratory will assess its own risks and may reach unique conclusions about the acceptability of those risks that are distinct from conclusions reached in another laboratory for similar risks. Risk acceptability will

also vary for normal operations compared to emergency operations. Determining what is necessary for optimal patient care and what risks are acceptable for the laboratory professional will ultimately depend on frequent communication and transparent decision-making among everyone involved in the management and operation of the clinical laboratory.

Summary

The OSHA BBP Standard (29 CFR Section 1910.1030) applies to all occupational exposure to human blood or other potentially infectious materials and directs the creation and implementation of a written Exposure Control Plan to eliminate or minimize employee exposure. Existing guidance (e.g., CDC, MMWR, BMBL) states that most clinical laboratories function as BSL-2 facilities with workers following Standard Precautions and BSL-2 practices.

Recent events, including the 2014–2016 Ebola outbreak, demonstrate that clinical laboratories need to adopt and support a risk management approach to biosafety and quality that emphasizes the importance of conducting activity- and laboratory-specific risk assessments; implementing mitigation measures based on the risks that are specific to that particular clinical laboratory setting; and integrating a rigorous performance evaluation process that embraces continual improvement. The preceding discussion outlined a range of topics unique to the clinical laboratory environment, and the content of this appendix should be used as a starting point for the development of a robust culture of safety in the clinical environment.

References

1. Hallworth MJ. The '70% claim': what is the evidence base?. *Ann Clin Biochem*. 2011;48(Pt 6):487–8.
2. Badrick T. Evidence-based laboratory medicine. *Clin Biochem Rev*. 2013;34(2):43–6.
3. Centers for Disease Control and Prevention [Internet]. Atlanta (GA): Clinical Laboratory Improvement Advisory Committee; c2016 [cited 2019 Mar 1]. Summary Report: April 13–14, 2016. Available from: https://ftp.cdc.gov/pub/CLIAAC_meeting_presentations/pdf/CLIAAC_Summary/cliac0416_summary.pdf
4. Gribble LA, Tria ES, Wallis L. The AMP Model. In: Salerno RM, Gaudio J, editors. *Laboratory Biorisk Management: Biosafety and Biosecurity*. Boca Raton (FL): CRC Press; 2015. p. 31–43.
5. CEN Workshop Agreement. *Laboratory Biorisk Management—Guidelines for the implementation of CWA 15793:2008*. Brussels: European Committee for Standardization; 2011.

6. Pentella MA. Components of a biosafety program for a clinical laboratory. In: Wooley DP, Byers KB, editors. *Biological Safety: Principles and Practices*. 5th ed. Washington (DC): ASM Press; 2017. p. 678–94.
7. Centers for Medicare & Medicaid Services [Internet]. Baltimore (MD): Clinical Laboratory Improvement Amendments (CLIA); c2017 [cited 2019 Mar 1]. Individualized Quality Control Plan (IQCP). Available from: https://www.cms.gov/Regulations-and-Guidance/Legislation/CLIA/Individualized_Quality_Control_Plan_IQCP.html
8. Standard; Laboratory director responsibilities, 42 C.F.R. Part 493.1445 (2010).
9. Pomerleau-Normandin D, Heisz M, Su M. Misidentification of Risk Group 3/Security Sensitive Biological Agents by MALDI-TOF MS in Canada: November 2015–October 2017. *Can Commun Dis Rep*. 2018;44(5):100–15.
10. Bloodborne pathogens, 29 C.F.R. Part 1910.1030 (1992).
11. Siegel JD, Rhinehart E, Jackson M, Chiarello L; the Healthcare Infection Control Practices Advisory Committee. *Guideline for Isolation Precautions: Preventing Transmission of Infectious Agents in Healthcare Settings*. Atlanta (GA): Centers for Disease Control and Prevention; 2007.
12. Miller MJ, Astles R, Baszler T, Chapin K, Carey R, Garcia L, et al. Guidelines for Safe Work Practices in Human and Animal Medical Diagnostic Laboratories. Recommendations of a CDC-convened, Biosafety Blue Ribbon Panel. *MMWR Suppl*. 2012;61(1):1–102. Erratum in: *MMWR Surveill Summ*. 2012;61(12):214.
13. Centers for Disease Control and Prevention [Internet]. Atlanta (GA): The National Institute for Occupational Safety and Health (NIOSH); c2015 [cited 2019 Mar 4]. Hierarchy of Controls. Available from: <https://www.cdc.gov/niosh/topics/hierarchy/default.html>
14. Dickson BA. Emerging Infectious Disease: Is Your Laboratory Ready?. In: 9th Annual Children’s Health Transfusion & Laboratory Medicine Conference; 2016 Feb 12; Dallas (TX). 2016.
15. Mississippi State Department of Health [Internet]. Jackson (MS): Biosafety Resources; c2013 [cited 2019 Mar 5]. When to Use the Biosafety Cabinet (poster): <https://msdh.ms.gov/msdhsite/index.cfm/14,0,188,547,html>
16. Nebraska Public Health Laboratory [Internet]. Omaha (NE). c2013 [cited 2019 Mar 5]. Bench Guide for Hazardous Pathogens. Available from: http://www.nphl.org/documents/NPHLBenchGuide_FINAL20131221.pdf
17. Association of Public Health Laboratories [Internet]. Silver Spring (MD): Partnerships & Outreach; c2018 [cited 2019 Mar 5]. Sentinel Clinical Laboratories. APHL Biothreat Identification Bench Cards. Available from: <https://www.aphl.org/programs/preparedness/Pages/partnerships-outreach.aspx>

18. Centers for Disease Control and Prevention [Internet]. Atlanta (GA): The National Institute for Occupational Safety and Health (NIOSH); c2018 [cited 2019 Mar 5]. Emergency Response Resources. Personal Protective Equipment. Available from: <https://www.cdc.gov/niosh/topics/emres/ppe.html>
19. United States Department of Labor [Internet]. Washington (DC): Occupational Safety and Health Administration; c2019 [cited 2019 Mar 5]. Personal Protective Equipment. Overview. Available from: <https://www.osha.gov/SLTC/personalprotectiveequipment/>
20. Ned-Sykes R, Johnson C, Ridderhof JC, Perlman E, Pollock A, DeBoy, JM; Centers for Disease Control and Prevention (CDC). Competency Guidelines for Public Health Laboratory Professionals: CDC and the Association of Public Health Laboratories. *MMWR Suppl.* 2015;64(1):1–81.
21. Kruse RH, Puckett WH, Richardson JH. Biological Safety Cabinetry. *Clin Microbiol Rev.* 1991;4(2):207–41.
22. Wooley DP, Byers KB. *Biological Safety: Principles and Practices.* 5th ed. Washington (DC): ASM Press; 2017.
23. CLSI. *Protection of Laboratory Workers from Occupationally Acquired Infections: Approved Guideline—Fourth Edition.* CLSI document M29-A4. Wayne (PA): Clinical and Laboratory Standards Institute; 2014.
24. Baron EJ, Miller JM. Bacterial and fungal infections among diagnostic laboratory workers: evaluating the risks. *Diagn Microbiol Infect Dis.* 2008;60(3):241–6.
25. Salerno R, Gaudioso J, editors. *Laboratory Biorisk Management—Biosafety and Biosecurity.* Boca Raton (FL): CRC Press; 2015.
26. Burnett L, Olinger P. Evaluating Biorisk Management Performance. In: Salerno RM, Gaudioso J, editors. *Laboratory Biorisk Management: Biosafety and Biosecurity.* Boca Raton (FL): CRC Press; 2015. p. 145–167.

Appendix O—Acronyms

A1HV-1	Alcelaphine Herpesvirus-1
ABSA	American Biological Safety Association
ABHS	Alcohol-Based Hand Sanitizer
ABSL	Animal Biosafety Level
ABSL-2Ag	Animal Biosafety Level 2-Agriculture
ABSL-3Ag	Animal Biosafety Level 3-Agriculture
ABSL-4Ag	Animal Biosafety Level 4-Agriculture
ACAV	American Committee on Arthropod-Borne Viruses
ACIP	Advisory Committee on Immunization Practices
ACG	Arthropod Containment Guidelines
ACL	Arthropod Containment Levels
ACME	American Committee of Medical Entomology
ADA	Americans with Disabilities Act
AHS	African Horse Sickness
AHSV	African Horse Sickness Virus
AIDS	Acquired Immune Deficiency Syndrome
AKAV	Akabane Virus
AMP	Antimicrobial Peptides
AMP	Assessment Mitigation Performance
AMT	Amotosalen
APHIS	Animal and Plant Health Inspection Service
APMV-1	Avian Paramyxovirus Type 1
APR	Air Pressure Resistant
ARS	Agricultural Research Service
ARDS	Acute Respiratory Distress Syndrome
ASF	African Swine Fever
ASFV	African Swine Fever Virus
ASHRAE	American Society of Heating, Refrigerating, and Air-Conditioning Engineers
ASTMH	American Society of Tropical Medicine and Hygiene
AVA	Anthrax Vaccine Adsorbed
BAT	Botulism Antitoxin
BCG	Bacillus Calmette-Guérin
BDV	Border Disease Virus
BI	Biological Indicator
BIS	Bureau of Science and Industry
BMBL	Biosafety in Microbiological and Biomedical Laboratories
BoNT	Botulinum neurotoxin

BREEAM	Building Research Establishment Environmental Assessment Method
BRM	Biorisk Management
BSAT	Biological Select Agents and Toxins
BSC	Biological Safety Cabinet
BSE	Bovine Spongiform Encephalopathy
BSL	Biosafety Level
BSO	Biosafety Officer
BTV	Bluetongue Virus
BVDL	Bovine Viral Diarrhea Virus
CAD	Clean Air Device
CAV	Constant Air Volume
CBPP	Contagious Bovine Pleuropneumonia
CCPP	Contagious Caprine Pleuropneumonia
CETBE	Central European Tick-Borne Encephalitis
CDC	Centers for Disease Control and Prevention
CFD	Computational Fluid Dynamics
CFR	Code of Federal Regulations
CFU	Colony Forming Units
CIP	Clean in Place
CJD	Creutzfeldt-Jakob Disease
CJIS	Criminal Justice Information Services Division
CLIA	Clinical Laboratory Improvement Amendments
CLIAC	Clinical Laboratory Improvement Advisory Committee
CNS	Central Nervous System
CSF	Cerebrospinal Fluid
CSFV	Classical Swine Fever Virus
CWD	Chronic Wasting Disease
DHHS	Department of Health and Human Services
DNA	Deoxyribonucleic Acid
DOC	Department of Commerce
DOD	Department of Defense
DOL	Department of Labor
DOT	Department of Transportation
DRM	NIH Design Requirements Manual
DTaP	Diphtheria Tetanus acellular Pertussis
EBV	Epstein-Barr Virus
ECP	Exposure Control Plan
EDS	Effluent Decontamination System
EEE	Eastern Equine Encephalomyelitis
ELISA	Enzyme-Linked Immunosorbent Assay

EMCS	Energy Monitoring and Control System
EO	Executive Order
EPA	Environmental Protection Agency
EtOH	Ethanol
EUE	Exotic Ungulate Encephalopathy
FBI	Federal Bureau of Investigation
FDA	Food and Drug Administration
FFI	Fatal Familial Insomnia
FIFRA	Federal Insecticide, Fungicide, and Rodenticide Act
FLA	Free Living Amebae
FMD	Foot and Mouth Disease
FMDV	Foot and Mouth Disease Virus
FQPA	Food Quality Protection Act
FSAP	Federal Select Agent Program
FSE	Feline Spongiform Encephalopathy
GAP III	Global Action Plan III
GCP	Good Clinical Practices
GHSA	Global Health Security Agenda
GI	Gastrointestinal Tract
GLP	Good Laboratory Practices
GMO	Genetically Modified Organism
GMP	Good Manufacturing Practices
GNR	Gram-Negative Rod
GSS	Gerstmann-Sträussler-Scheinker Syndrome
H	Hemagglutinin
HAV	Hepatitis A Virus
HEPA	High-Efficiency Particulate Air
HBV	Hepatitis B Virus
HCMV	Human Cytomegalovirus
HCV	Hepatitis C Virus
HCW	Healthcare Workers
HD	Heartwater Disease
HDV	Hepatitis D Virus
HEV	Hepatitis E Virus
HeV	Hendra Virus
HFRS	Hemorrhagic Fever with Renal Syndrome
HHV	Human Herpes Virus
HHV-6A	Human Herpes Virus 6A
HHV-6B	Human Herpes Virus 6B
HHV-7	Human Herpes Virus 7

HHV-8	Human Herpes Virus 8
HIPPA	Health Insurance Portability and Accountability Act
HIV	Human Immunodeficiency Virus
HPAI	Highly Pathogenic Avian Influenza
HPAIV	Highly Pathogenic Avian Influenza Virus
HPS	Hantavirus Pulmonary Syndrome
HSE	Health, Safety, and Environment
HSV-1	Herpes Simplex Virus 1
HSV-2	Herpes Simplex Virus 2
HTLV	Human T-Lymphotropic Viruses
HVAC	Heating, Ventilation, and Air Conditioning
IA	Impact Assessment
IACUC	Institutional Animal Care and Use Committee
IATA	International Air Transport Association
IBC	Institutional Biosafety Committee
ICAO	International Civil Aviation Organization
ICTV	International Committee on Taxonomy of Viruses
ID	Infectious Dose
ID50	Number of organisms necessary to infect 50% of a group of animals
IDLH	Immediately Dangerous for Life and Health
IES	APHIS Investigative and Enforcement Services
IFU	Instructions for Use
IgG	Immunoglobulin
IGRA	Interferon-Gamma Release Assay
ILAR	Institute for Laboratory Animal Research
IND	Investigational New Drug
IPM	Integrated Pest Management
IPV	Inactivated Poliovirus Vaccine
IQCP	Individualized Quality Control Plan
ISA	Infectious Salmon Anemia
ISAV	Infectious Salmon Anemia Virus
LAI	Laboratory-associated infections
LCM	Lymphocytic Choriomeningitis
LCMV	Lymphocytic Choriomeningitis Virus
LCV	Large Cell Variant
LD	Lethal Dose
LED	Light Emitting Diode
LEED	Leadership in Energy and Environmental Design
l/m	Linear Feet Per Minute
LGV	Lymphogranuloma Venereum

LMW	Low Molecular Weight
LSD	Lumpy Skin Disease
LSDV	Lumpy Skin Disease Virus
MALDI-TOF	Matrix-Assisted Laser Desorption/Ionization-Time of Flight Mass Spectrometry
MCF	Malignant Catarrhal Fever
MDR	Multidrug-Resistant
MenV	Menangle Virus
MERS	Middle East Respiratory Syndrome
MERS-CoV	Middle East Respiratory Syndrome Coronavirus
MIT	Massachusetts Institute of Technology
MMWR	Morbidity and Mortality Weekly Report
MOTT	Mycobacteria Other Than Tuberculosis
MPPS	Most Penetrating Particle Size
MVA	Modified Vaccinia Ankara
NaOCl	Sodium Hypochlorite
NaOH	Sodium Hydroxide
N	Neuraminidase
NBL	National Biocontainment Laboratory
NC	Noise Criterion
NCI	National Cancer Institute
ND	Newcastle Disease
NDV	Newcastle Disease Virus
NHP	Non-human Primate
NIH	National Institutes of Health
NiV	Nipah Virus
NIOSH	National Institute for Occupational Safety and Health
NSF	National Science Foundation
NTM	Non-tuberculous Mycobacterium
OIG	Office of the Inspector General
OIE	World Organization for Animal Health
OPIM	Other Potential Infectious Material
OPM	Owner's Project Requirements
OPV	Oral Poliovirus Vaccine
OSHA	Occupational Safety and Health Administration
OSP	Office of Science Policy
PAPR	Positive Air-Purifying Respirator
PBT	Pentavalent Botulinum Toxoid Vaccine
PCR	Polymerase Chain Reaction
PEL	Permissible Exposure Level

PEP	Post-exposure Prophylaxis
PI	Principal Investigator
PM	Preventative Maintenance
PPD	Purified Protein Derivative
PPE	Personal Protective Equipment
PPM	Parts Per Million
PPQ	Plant Protection and Quarantine
PPRV	Pest des Petits Ruminants Virus
PrP	Prion Protein
PTFE	Polytetrafluoroethylene
PV1	Poliovirus serotype 1
PV2	Poliovirus serotype 2
PV3	Poliovirus serotype 3
QMS	Quality Management System
RAC	Recombinant DNA Advisory Committee
RBL	Regional Biocontainment Laboratory
RG	Risk Group
RIP	Ribosome-Inactivating Protein
RNA	Ribonucleic Acid
RO	Responsible Official
RoD	Risk of Disease
RoE	Risk of Exposure
RP	Rinderpest
RPV	Rinderpest Virus
RVFV	Rift Valley Fever Virus
SAIDS	Simian AIDS
SAL	Sterility Assurance Level
SALS	Subcommittee on Arbovirus Laboratory Safety
SARS	Severe Acute Respiratory Syndrome
SARS-CoV	SARS-Associated Coronavirus
SBA	Sheep Blood Agar
SCBA	Self-Contained Breathing Apparatus
SCID	Severe Combined Immunodeficiency
sCJD	Sporadic Creutzfeldt-Jakob-Disease
SC type	Small-Colony type
SCV	Small Cell Variant
SDS	Safety Data Sheet (Appendix B)
SDS	Sodium Dodecyl Sulfate (Section VIII-H)
SE	Staphylococcal Enterotoxins
SEA	SE Serotype A

SEB	SE Serotype B
SEC	SE Serotype C
SED	SE Serotype D
SEE	SE Serotype E
SHE	SE Serotype H
SFV	Simian Foamy Virus
SHIV	Simian/Human Immunodeficiency Virus
SIP	Sterilization in Place
SIV	Simian Immunodeficiency Virus
SGP	Sheep and Goat Pox
SGPV	Sheep and Goat Pox Virus
SLE	St. Louis Encephalitis virus
SME	Subject Matter Expert
SNS	US Strategic National Stockpile
SOP	Standard Operating Procedure
SRA	Security Risk Analysis
SRV	Simian type D Retrovirus
STLV	Simian T-Lymphotropic Virus
SU	Single-Use
SVCV	Spring Viremia of Carp Virus
SVD	Swine Vesicular Disease
SVDV	Swine Vesicular Disease Virus
TBEV-CE	Tick-Borne Encephalitis Virus- Central European subtype
TBEV-FE	Tick-Borne Encephalitis Virus- Far Eastern subtype
TLV	Threshold Limit Values
TME	Transmissible Mink Encephalopathy
TNF	Tumor Necrosis Factor
TSE	Transmissible Spongiform Encephalopathy
TVOC	Total Volatile Organic Compounds
ULPA	Ultra-Low Particulate Air
ULT	Ultra-Low Temperature
UP	Universal Precautions
UPS	Uninterruptable Power Supply
UV	Ultraviolet
USAMRIID	U.S. Army Medical Research Institute of Infectious Diseases
USC	U.S. Code
USDA	U.S. Department of Agriculture
USPS	United States Postal Service
VAPP	Vaccine-Associated Paralytic Polio
VAV	Variable Air Volume

VDPV2	Vaccine-Derived Polio Type 2 Virus
VEEV	Venezuelan Equine Encephalitis Virus
VS	Veterinary Services
VZV	Varicella-Zoster Virus
WBC	White Blood Cell
WEEV	Western Equine Encephalomyelitis Virus
WHO	World Health Organization
WMD	Weapons of Mass Destruction
WNV	West Nile Virus
XDR	Extensively Drug-Resistant

Glossary

Agent: In a biological context, a microorganism, biological toxin, or human endoparasite, either naturally occurring or genetically modified, with the potential to cause infection, allergy, toxicity, or otherwise, create a hazard to human health.

Agricultural biosecurity: The scientifically-based policies, measures, and regulatory frameworks that are applied to protect, manage, and respond to risks associated with food, agriculture, health, and the environment.

Air sweep: Within a BSC, use of the downflow air after slowly placing arms and hands inside the BSC to remove particulates prior to starting work.

Attenuation: A method to minimize disease risk that involves using a weakened form of a pathogen, viral nucleic acid sequences, or a toxin.

Bioburden reduction studies: See *spike-and-recovery experiments*.

Biorisk: The effect of uncertainty expressed by the combination of the consequences of an event and the associated likelihood of occurrence, where biological material is the source of harm.

Biorisk management: Coordinated activities to direct and control an organization with regard to biorisk.

Bloodborne pathogens: Pathogenic microorganisms present in human blood and other potentially infectious materials (OPIM), which can infect and/or cause disease in persons who are exposed to blood or OPIM containing these pathogens.

Cell type: A classification that distinguishes between morphologically or phenotypically different forms within an organism.

Clean bench: A device that directs HEPA-filtered air horizontally or vertically over a surface, towards the user.

Cleanroom: A room that utilizes HEPA-filtered supply air to reduce the amount particulate contamination to a designated level (e.g., ISO Class 4 allows no more than 1.0×10^4 particles/m³ with a size $\geq 0.1 \mu\text{m}$).

Clean to dirty: In the context of workflow, a process of working within a BSC that segregates unused (e.g., clean) or sterile materials on one side of the cabinet from used (e.g., dirty) materials on the other, with a central working area. For a right-handed person, the clean material will generally be on the right, and the dirty material will be on the left; the opposite orientation is appropriate for a left-handed person. In the context of airflow, it is the preferred direction of air movement, from areas of lower potential contamination to those of higher potential contamination.

Cleaning: A process to reduce or remove adherent organic and inorganic soil (e.g., blood proteins, debris and biological matter, and other material) from surfaces usually with detergent and water.

Confirmed Inactivation Procedure: A method that has been tested and determined under specified conditions to have adequate efficacy in rendering a pathogen non-viable (i.e., viability testing); viral nucleic acid sequences that can produce infectious forms of a virus non-infectious (i.e., infectivity testing); or a toxin no longer capable of exerting a toxic effect (i.e., toxicity testing).

Contact time: The time required for a process or chemical treatment to inactivate a microorganism on the surface or item, which may depend on the number of organisms present and other variables (e.g., temperature, organic load, water hardness).

Containment: A combination of primary and secondary containment barriers, facility practices and procedures, and other safety equipment, such as personal protective equipment (PPE), for managing the risks associated with handling and storing hazardous biological agents and toxins in a laboratory environment.

Culture type: Animal cell cultures can be characterized into three types—explants, primary cell lines, and immortal cell lines. The risk of explants and primary cell lines directly derived from explants are frequently poorly characterized and may pose unknown risks to the researcher.

Decontamination: The use of physical and/or chemical means to remove, inactivate, or destroy microbial pathogens (e.g., bloodborne or aerosolized) on a surface or item to the point where they are no longer capable of transmitting infectious particles and the item or surface is rendered safe to handle; however, this definition has been broadened by infection control specialists to include all pathogens and physical spaces (e.g., patient rooms, laboratories, buildings).

Directional airflow: Movement of air in one direction to minimize potential cross-contamination from aerosols.

Disinfectant: A substance, or mixture of substances, that destroys or irreversibly inactivates bacteria, fungi, and viruses, but not necessarily bacterial spores or prions, in the inanimate environment.

Disinfection: A process that destroys pathogens and other microorganisms, except prions, by physical or chemical means.

High-Level Disinfection: A lethal process utilizing a sterilant under less than sterilizing conditions (e.g., 10–30 min contact time instead of 6–10 h needed for sterilization). The process kills all forms of microbial life except for large numbers of bacterial spores.

- **Intermediate-Level Disinfection:** A lethal process utilizing an agent that kills viruses, mycobacteria, fungi, and vegetative bacteria, but no bacterial spores.
- **Low-Level Disinfection:** A lethal process utilizing an agent that kills vegetative forms of bacteria, some fungi, and enveloped viruses.

Endogenous pathogens: Pathogens normally associated with a host and not provided as part of an experimental protocol.

Etiologic agent: An agent capable of causing disease—usually a pathogen such as a bacterium, virus, parasite, fungus, or toxin. Now replaced with the term *infectious materials* or *infectious substances* in 49 CFR Parts 171–180.

Exempt Organisms: Organisms listed under Appendix C of the *NIH Guidelines*, including K-12 derived strains of *E. coli*. These organisms are generally considered not to pose a significant risk to health or the environment and are exempt from the requirements of the *NIH Guidelines*.

Facility: A building, or portion of a building, which houses laboratories or animal facilities and all of their associated functions (e.g., autoclave rooms, equipment rooms, feed rooms, cage wash areas). For higher containment areas, it may include only the rooms within the containment boundary.

Federal Insecticide, Fungicide, and Rodenticide Act (FIFRA): FIFRA provides for federal regulation of pesticide distribution, sale, and use. All pesticides, including antimicrobial pesticides, distributed or sold in the United States must be registered (i.e., licensed) by the EPA. Manufacturers submit efficacy data to the EPA to support product claims.

Inactivation: A procedure to render a pathogen non-viable, viral nucleic acid sequences non-infectious, or a toxin non-toxic while retaining characteristic(s) of interest for future use. Methods targeting tropism may be host-specific.

Infectious materials: Any material, solid or liquid, which contains biological agents capable of causing infection in either humans, animals or both.

Infectious substances: Substances that are known or are reasonably expected to contain pathogens. Infectious substances can include patient specimens, biological cultures, medical or clinical wastes and/or biological products such as vaccines.

Infectivity testing: A process to confirm efficacy of the inactivation procedure by demonstrating that viral nucleic acid sequences are incapable of producing infectious forms of viruses. Efficacy assessments on methods that target tropism may be host-specific.

Institutional Biosafety Committee (IBC): The committee required under the *NIH Guidelines* to review and approve research with recombinant or synthetic nucleic acids. The committee may also take on additional tasks, such as review of all work with biological agents. Sites not subject to the *NIH Guidelines* may choose to establish an IBC or use a committee with a similar name (e.g., site biosafety committee, institutional safety committee) to oversee research with recombinant or synthetic nucleic acids and/or biological agents. IBC is the generic term used in the BMBL.

Institutional verification: Affirmation by an entity that the set of confirmed inactivation and separation/removal procedures used at that entity result in end products that achieve adequate inactivation efficacy.

Instructions for use (IFU): Section of the product label that includes manufacturer's instructions for using a product safely (i.e., dilution, contact time, how to apply). The manufacturer may also have an extended label that provides additional instructions.

Laboratory: A room, or series of rooms, which may or may not be contiguous, used for research under the control of a single supervisor or principal investigator.

Laboratory biosecurity: The measures designed to prevent loss, theft, or deliberate misuse of biological material, technology, or research-related information from laboratories or laboratory-associated facilities.

Laminar flow: Laminar flow occurs when the fluid (i.e., air) flows in infinitesimal parallel layers with no disruption between them. In laminar flows, fluid layers slide in parallel, with no eddies, swirls or currents normal to the flow itself.

Mask: A covering over the the mouth and nose, not certified to provide respiratory protection. May be used to provide mucous membrane protection from droplets. Not equivalent to a respirator.

Material: In a biological context, any material comprised of, containing, or that may contain biological agents and/or their harmful products, such as toxins or allergens. Biological materials may be blood, secretions, or tissues of human or animal origin, debris, organic material from nature, culture or preservation media, human, animal, and plant cultures.

Microorganism: A biological agent that is often unicellular or acellular, capable of replication or of transferring genetic material, including bacteria, viruses, fungi, and parasites.

Pathogen: Microorganisms (e.g., bacteria, viruses, rickettsiae, parasites, fungi) and other agents such as prions, which can cause disease in humans, animals, or plants.

Penetration: a deliberate hole or opening in a surface (e.g., wall, floor, ceiling) that must be sealed to prevent air leakage from a facility or laboratory.

Persons: All individuals at a facility, whether employees, contractors, or visitors.

Pest: A pest is an organism living and growing where their presence is undesired or unintentional. A pest can cause damage to plants, humans, structures, and other creatures.

Pesticide label: Pesticide product labels provide critical information about how to safely and legally handle and use pesticide products (e.g., antimicrobial pesticides). Unlike most other types of product labels, pesticide labels are legally enforceable, and all of them carry the statement: "It is a violation of Federal law to use this product in a manner inconsistent with its labeling."

Pre-cleaning: The removal of bulk contaminating material not part of the material or surface being cleaned.

Process verification: Demonstration that use of an inactivation procedure that employs the set of specified conditions established in the confirmation study(s) has achieved adequate efficacy.

Product Labeling: This is any legend, artwork, or mark attached to disinfectant. It will include IFUs, EPA registry number, and label claims (e.g., microorganisms tested for EPA registry).

Purge (BSC): Process of providing time to allow BSC airflow to filter cabinet air and remove contaminants from the air prior to starting work or concluding experiments in a BSC.

Respirator: A device to provide protection from aerosols or vapors, depending on the filtration medium. It is approved by regulatory entities and requires documented training, fit testing, and medical surveillance.

Restricted experiment: Experiments that potentially provide drug resistance to U.S. Select Agents, if the acquisition could compromise the control of the disease agent, or experiments that deliberately create synthetic or recombinant genes for the synthesis of Select Toxins lethal at a LD₅₀ of less than 100 ng/kg.

Risk ethics: Principles that morally guide rational choices on risk-taking and risk exposure and are important considerations of risk management.

Room: The smallest physical subdivision of a laboratory or facility.

Root cause analysis: A collective term that describes a wide range of approaches, tools, and techniques used to uncover causes of problems. The root cause is the core issue that sets in motion the entire cause-and-effect reaction that ultimately leads to the problem(s).

Sanitizers: A chemical preparation and an antimicrobial agent for killing at least 99.9% of microorganisms. Sanitizers are typically used on food contact surfaces, carpet, in-tank toilet bowl additives, laundry additives, and air fresheners.

Sight sealed: Visual inspection of sealed areas in BSL-3 laboratories, including walls, ceilings, and floors.

Spike-and-recovery experiments: Studies based on deliberately adding a specific agent (i.e., spiking) and subsequently measuring the removal or inactivation during inactivation steps. Also known as bioburden reduction studies.

Sporicide: A substance, or mixture of substances, that irreversibly inactivates bacterial spores in the inanimate environment.

Staff: All full-time equivalent employees and part-time employees, as well as other categories (e.g., students, fellows, and guest researchers) at a facility, who are provided occupational health and other services by the institution.

Sterility assurance level (SAL): The probability of survival of microorganisms after terminal sterilization, and a predictor of the efficacy of the process.

Sterilant: A substance or mixture of substances that destroys or eliminates all forms of microbial life in the inanimate environment including all forms of vegetative bacteria, bacterial spores, fungi, fungal spores, and viruses.

Sterilization: A physical or chemical process that kills or inactivates all microbial life forms including highly resistant bacterial spores.

Tested cell lines: Human cell lines that have been tested for bloodborne pathogens. Also refers to cell lines that have been tested to demonstrate the absence of specific pathogens.

Tissue source: The organism, or the organ, from which a specific tissue was removed for scientific use.

Tissue type: Animal tissue is categorized into one of four types—connective, muscle, nervous, and epithelial.

Toxicity testing: A process to confirm efficacy of the inactivation procedure by demonstrating the toxin is no longer capable of exerting a toxic effect.

Trigger point: A recognized combination of diagnostic findings that can be used to determine when to heighten the precautions or conditions for handling a sample or culture.

Validated inactivation procedure: A procedure that renders a microorganism non-viable but allows the microorganism to retain characteristics of interest for future use; the efficacy is confirmed by data generated from a viability testing protocol.

Validation: Establishment of the performance characteristics of a method and provision of objective evidence that the performance requirements for a specified intended use are fulfilled.

Verification: Demonstration that a validated method functions in the user's hands according to the method's specifications determined in the validation study and is fit for purpose.

Viability testing protocol: A process to confirm efficacy of the inactivation procedure by demonstrating the material is free of all viable pathogens.

Index

A

African horse sickness 308

Allergic reactions 234

Animal Biosafety Level-Agriculture

Animal Biosafety Level 2 Agriculture

ABSL-2Ag 30, 71, 424, 429, 430, 431, 432, 433, 544

Animal Biosafety Level 3 Agriculture

ABSL-3Ag 30, 65, 71, 107, 110, 114, 117, 262, 306, 326, 329, 424, 433, 434, 435, 436, 437, 438, 440, 441, 442, 443, 444, 544

Animal Biosafety Level 4 Agriculture

ABSL-4Ag 30, 65, 71, 107, 110, 114, 117, 424, 443, 444, 445, 446, 544

Animal Biosafety Levels 30, 70, 71

ABSL 28, 30, 61, 65, 68, 70, 71, 72, 76, 78, 84, 87, 92, 94, 96, 97, 98, 102, 103, 106, 107, 108, 110, 112, 114, 116, 117, 140, 149, 152, 153, 155, 156, 158, 160, 161, 163, 164, 165, 166, 168, 169, 171, 172, 173, 174, 176, 177, 179, 181, 182, 184, 185, 186, 188, 189, 190, 213, 214, 216, 217, 218, 227, 229, 231, 233, 240, 243, 248, 249, 250, 251, 252, 255, 260, 261, 262, 265, 267, 270, 271, 276, 278, 303, 306, 326, 329, 424, 426, 427, 428, 429, 430, 431, 432, 433, 434, 435, 436, 437, 438, 439, 440, 441, 442, 443, 444, 445, 446, 457, 510, 513, 544

Animal Biosafety Level 1 71

ABSL-1 71, 72, 76, 78

Animal Biosafety Level 2 78, 424, 429, 544

ABSL-2 28, 71, 78, 84, 87, 149, 152, 158, 160, 161, 163, 164, 165, 168, 169, 171, 172, 173, 174, 176, 177, 179, 181, 182, 184, 185, 186, 188, 189, 213, 214, 216, 217, 218, 227, 229, 231, 233, 243, 248, 250, 251, 252, 260, 261, 265, 267, 270, 271, 276, 424, 426, 429

Animal Biosafety Level 3 30, 87, 433, 510, 513, 544

ABSL-3 68, 87, 92, 94, 96, 97, 98, 140, 153, 155, 156, 160, 166, 174, 190, 240, 250, 261, 262, 265, 270, 278, 303, 306, 424, 427, 428, 429, 433, 439, 442, 446, 457, 510, 513

Animal Biosafety Level 4 98, 443, 544

ABSL-4 61, 65, 98, 102, 103, 106, 108, 110, 112, 114, 116, 140, 248, 249, 255, 270, 424, 429, 433, 443, 444, 445

Anthrax 148, 191, 192, 193, 544

Arboviruses 292, 295, 298, 308, 327, 333

Arenaviruses 307

Arthropod containment 458, 459

Ascaris 234

B

Bacillus anthracis 148, 192, 408, 411, 413, 491, 501, 534

Bacillus subtilis 28, 404

Biological agents 27, 407

Biological safety cabinets

BSCs 16, 24, 25, 36, 37, 40, 42, 43, 50, 58, 60, 61, 64, 65, 68, 69, 70, 83, 86, 87, 93, 96, 97, 98, 106, 108, 109, 112, 114, 242, 294, 363, 367, 368, 369, 370, 371, 372, 374, 375, 376, 377, 378, 379, 380, 381, 384, 385, 386, 387, 388, 424, 438, 442, 471, 532, 535

Class I 24, 367, 368, 370, 377, 388, 390

Class II 30, 61, 98, 109, 216, 217, 218, 294, 335, 347, 367, 370, 371, 372, 373, 374, 375, 377, 378, 381, 386, 387, 388, 389, 390, 391, 392, 393, 395, 471, 475, 532

Class III 30, 50, 51, 57, 58, 65, 97, 98, 104, 105, 106, 114, 367, 375, 376, 394, 397, 471, 475

Biorisk 20, 119, 129, 515, 541, 543, 545, 552

Biosafety Levels 4, 9, 11, 27, 30, 32, 68, 70, 71, 120, 139, 261, 263, 298, 299, 307, 367, 368, 459

Biosafety Level 1 4, 28, 32, 71

BSL-1 4, 5, 28, 29, 32, 37, 71, 270, 388, 510

Biosafety Level 2 4, 28, 30, 37, 78, 424, 429, 544

BSL-2 4, 14, 28, 29, 30, 37, 40, 119, 149, 152, 153, 155, 156, 158, 160, 161, 163, 164, 165, 167, 168, 169, 170, 172, 173, 174, 176, 177, 179, 180, 182, 183, 185, 186, 188, 189, 190, 213, 214, 216, 217, 218, 219, 227, 229, 231, 233, 240, 242, 243, 248, 251, 252, 255, 258, 260, 261, 265, 267, 270, 271, 272, 276, 278, 279, 292, 293, 294, 295, 301, 304, 306, 307, 335, 339, 342, 347, 357, 359, 360, 384, 424, 426, 459, 468, 472, 510, 531, 538, 541

Biosafety Level 3 4, 29, 30, 43, 87, 117, 246, 331, 397, 433, 510, 513, 544

BSL-3 4, 27, 29, 43, 47, 51, 68, 92, 119, 122, 140, 143, 149, 152, 153, 155, 156, 160, 161, 166, 169, 174, 175, 177, 179, 182, 190, 213, 214, 216, 240, 241, 242, 243, 248, 252, 255, 258, 261, 262, 265, 270, 271, 272, 276, 278, 292, 294, 295, 296, 297, 301, 303, 306, 307, 329, 335, 339, 357, 360, 379, 384, 405, 407, 424, 427, 428, 429, 436, 439, 446, 457, 473, 510, 513, 557

Biosafety Level 4 4, 29, 51, 98, 443, 544

BSL-4 4, 16, 29, 30, 51, 52, 55, 56, 58, 59, 61, 62, 63, 65, 103, 110, 114, 122, 140, 249, 255, 270, 296, 297, 307, 372, 384, 388, 405, 407, 424, 429, 445

BSL 4, 5, 14, 16, 27, 28, 29, 30, 32, 37, 40, 43, 47, 51, 52, 55, 56, 58, 59, 61, 62, 63, 65, 68, 69, 71, 92, 103, 110, 114, 119, 122, 131, 140, 143, 149, 152, 153, 155, 156, 158, 160, 161, 163, 164, 165, 166, 167, 168, 169, 170, 172, 173, 174, 175, 176, 177, 179, 180, 182, 183, 185, 186, 188, 189, 190, 213, 214, 216, 217, 218, 219, 227, 229, 231, 233, 240, 241, 242, 243, 248, 249, 251, 252, 255, 258, 260, 261, 262, 265, 267, 270, 271, 272, 276, 278, 279, 292, 293, 294, 295, 296, 297, 301, 303, 304, 306, 307, 308, 329, 335, 339, 342, 347, 357, 359, 360, 367, 372, 379, 384, 388, 405, 407, 424, 426, 427, 428, 429, 436, 439, 445, 446, 457, 459, 468, 472, 473, 510, 513, 531, 538, 541, 545, 557

Biosafety Officer 545

BSO 19, 70, 387, 545

Biosecurity 6, 20, 23, 31, 119, 120, 122, 123, 124, 129, 144, 524, 528, 541, 543

Bioterrorism 348, 460

Blastomyces dermatitidis 1, 212, 219

Bloodborne pathogens 21, 31, 118, 143, 466, 469, 542, 552

Bordetella pertussis 150, 193, 194

Botulinum neurotoxin 478, 480, 544

Botulism 198, 334, 336, 347, 348, 481, 544

Brucella 1, 2, 8, 152, 153, 154, 194, 195, 447, 503

abortus 152, 154, 194, 195, 447, 503

canis 152, 167, 168, 234, 235, 447, 449, 451

melitensis 2, 8, 152, 154, 194, 447

suis 152, 154, 447, 449, 452, 503

Brucellosis 153, 194, 195

Burkholderia mallei 154, 195

Burkholderia pseudomallei 156, 195, 196

B virus 1, 12, 13, 22, 28, 31, 132, 138, 146, 251, 253, 254, 255, 256, 257, 258, 259, 282, 283, 284, 303, 466, 467. **See also** Macacine herpesvirus

C

Campylobacter 157, 158, 196, 197, 202, 209, 447

coli 182, 183, 208, 209, 447, 448, 503, 554

fetus 157, 171, 172, 197, 258, 447, 451

jejuni 196, 197, 209, 447

Chimeric viruses 299

Chlamydia 2, 14, 158, 159, 160, 197, 198, 447

pneumoniae 158, 159, 160, 198, 447

psittaci 2, 14, 158, 159, 160, 197, 198, 447

trachomatis 158, 159, 160, 198, 447

Cholera 210, 211

Clean 362, 376, 394, 395, 399, 518, 545, 552

Clostridium 161, 162, 163, 198, 199, 200, 334, 335, 337, 348, 404, 447, 454, 479, 481, 482, 503

botulinum 161, 198, 334, 336, 347, 348, 447, 470, 478, 479, 480, 481, 482

tetani 163, 200

Coccidioides immitis 2, 14, 213, 220

Coccidioides posadasii 213, 220

Congo-Crimean hemorrhagic fever 29

Conidia 215

Containment 4, 57, 71, 105, 118, 146, 149, 151, 153, 155, 156, 157, 159, 161, 163, 164, 165, 166, 168, 169, 170, 171, 172, 174, 176, 177, 179, 180, 182, 183, 185, 186, 187, 189, 190, 191, 211, 213, 214, 216, 217, 222, 227, 229, 231, 232, 235, 240, 242, 247, 249, 251, 252, 254, 258, 260, 264, 266, 267, 269, 271, 275, 278, 287, 293, 294, 295, 297, 301, 303, 306, 326, 330, 335, 339, 342, 346, 357, 367, 368, 386, 397, 457, 458, 459, 472, 513, 519, 520, 544, 553

Primary containment 106, 152, 155, 376

Corynebacterium diphtheriae 164, 201

Coxiella burnetii 1, 2, 13, 14, 29, 239, 244, 245

Creutzfeldt-Jakob 355, 363, 364, 365, 408, 545, 549

Cytomegalovirus 287, 546

D

Decontamination 48, 59, 62, 64, 66, 83, 92, 107, 111, 113, 115, 383, 384, 398, 400, 403, 405, 406, 410, 411, 435, 436, 438, 476, 477, 480, 518, 545, 553

Dengue 312

Dermatophytes 217

Epidermophyton 218, 449

Microsporum 218, 449

Trichophyton 218, 404, 449

Diphtheria 152, 200, 545
Disinfection 400, 401, 402, 410, 411, 412, 413, 553, 554
DOT Packaging Requirements 418

E

Ebola 146, 310, 312, 321, 323, 324, 404, 501, 529, 533, 541
Encephalitis 295, 302, 305, 308, 309, 310, 311, 312, 313, 314, 316, 317, 319,
320, 321, 322, 323, 324, 325, 329, 453, 454, 545, 550, 551
Epidermophyton 218, 449
Escherichia coli 182, 208, 209, 503

F

Facility 16, 25, 26, 50, 59, 63, 71, 73, 79, 88, 98, 99, 104, 106, 108, 112, 367,
384, 427, 430, 434, 444, 457, 464, 481, 504, 554
Facility design 50
Fasciola 232, 450
Francisella tularensis 1, 14, 165
Fungal Agents 212

G

Giardia 228, 450
Gloves 34, 38, 44, 53, 58, 74, 80, 89, 100, 101, 105, 118, 252, 360, 383, 409
Gonorrhea 177
Guidelines 3, 8, 11, 12, 17, 21, 23, 27, 28, 71, 131, 142, 143, 144, 145, 150,
163, 186, 191, 211, 255, 270, 284, 288, 293, 330, 365, 397, 413, 439, 456, 458,
469, 470, 484, 485, 509, 513, 515, 524, 527, 541, 542, 543, 544, 554, 555

H

Hantaviruses 247, 307
Helicobacter pylori 167, 201, 202
Hemorrhagic fever 280, 304
Hendra virus 248, 249, 281
HEPA filter 49, 51, 57, 62, 65, 66, 93, 97, 105, 110, 114, 115, 329, 363, 369,
370, 371, 372, 373, 374, 375, 376, 385, 386, 387, 388, 390, 391, 392, 393, 394,
395, 396, 398, 428, 440, 441, 474
Hepatitis 28, 250, 251, 252, 282, 283, 452, 453, 466, 546
 A virus 250, 251, 259, 285, 502

B virus

HBV 1, 2, 12, 251, 252, 253, 283, 404, 466, 469, 546

C virus 2, 12, 251, 252, 282, 283, 466

HCV 12, 138, 251, 252, 253, 283, 404, 466, 469, 546

D virus 251

HDV 251, 252, 253, 546

E virus 250, 251

Histoplasma 215, 216, 449

capsulatum 215, 216, 449

farciminosum 449

Human immunodeficiency virus

HIV 12, 28, 132, 174, 217, 257, 273, 274, 275, 276, 282, 289, 331, 404, 466, 469, 547

Hypr 295, 314

I

Influenza 21, 259, 260, 261, 262, 285, 286, 453, 547

Institutional Biosafety Committee 7, 32, 72, 79, 87, 99, 468, 547, 555

IBC 10, 16, 18, 32, 70, 72, 79, 87, 99, 262, 276, 299, 300, 485, 547, 555

Investigational New Drug 547

IND 296, 336, 547

J

Junin virus 295, 331

K

Kuru 355, 356, 358

Kyasanur Forest disease 316

L

Laboratory-associated infection 2, 6, 21, 129, 142, 144, 145, 168, 169, 171, 172, 194, 195, 196, 197, 199, 200, 203, 204, 207, 208, 209, 224, 226, 281, 282, 284, 285, 286, 287, 288, 332, 340, 345, 347, 348, 350, 351, 360, 365, 406, 407, 408, 410, 411, 448, 451, 456, 469, 480, 502, 503, 504, 541, 542, 543

LAI 1, 2, 6, 9, 17, 21, 129, 130, 134, 136, 137, 138, 139, 140, 141, 142, 144, 145, 157, 168, 169, 171, 172, 178, 180, 182, 184, 185, 194, 195, 196, 197, 199, 200, 203, 204, 207, 208, 209, 212, 224, 226, 239, 263, 281, 282, 284, 285, 286, 287, 288, 290, 295, 332, 340, 345, 347, 348, 350, 351, 360, 365,

406, 407, 408, 410, 411, 448, 451, 456, 469, 480, 502, 503, 504, 539, 541,
542, 543, 547

Laboratory biosecurity 120, 122, 124, 128, 555

Laboratory security and emergency response 128

Legionella pneumophila 168

Leishmania spp. 223, 224, 226, 451

Leprosy 172, 204

Leptospira interrogans 202

Leptospirosis 170, 202

Listeria monocytogenes 171, 203

Loose-housed animals 262

Low molecular weight toxin

LMW 343, 346, 347, 479, 480, 548

Lumpy skin disease virus

LSDV 548

Lymphocytic choriomeningitis 264, 286, 287, 293, 317

Lymphogranuloma venereum

LGV 158, 159, 160, 547

M

Macacine herpesvirus 13, 467

MHV-1 13

Malaria 223, 224, 226

Mammalian Cells and Tissues 466

Marburg 29, 318, 321, 501

Mask 555

Menangle virus

MenV 548

Mice 22, 264, 286

Microsporium 218, 449

Molds 218, 219, 449

Monkeypox 269, 453

Mycobacterium 1, 2, 21, 29, 132, 172, 173, 175, 176, 203, 204, 205, 402, 404,
448, 466, 530, 548

avium 175, 176, 205, 448
bovis 173, 174, 175, 204, 205, 402, 404, 448, 450
fortuitum 176, 448
kansasii 175, 176
leprae 172, 175
marinum 176, 205, 448
scrofulaceum 175, 448
ulcerans 164, 176, 201

N

Naegleria 28, 223, 226
fowleri 223, 226
Nairobi sheep disease 319
Neisseria 177, 178, 206, 534
gonorrhoeae 177, 178
meningitidis 178, 179, 533, 534
Nematode parasites 233
Newcastle disease virus
NDV 320, 548
NIH Guidelines 3, 8, 11, 12, 17, 21, 27, 28, 131, 143, 270, 288, 458, 469, 484, 485, 515, 524, 554, 555

O

Occupational health 118, 130, 131, 141
Orientia 241, 448
tsutsugamushi 241, 448

P

Paramyxovirus 544
Parasitic agents
Blood and Tissue Protozoal Parasites 223
Cestode 230
Intestinal 228
Nematode 233
Trematode 232
Pathogens 28, 192, 196, 202, 207, 290, 348, 365, 402, 410, 416, 418, 423, 424, 426, 427, 429, 531, 537, 542, 554

Performance Testing BSCs 388
Personal protective equipment 25, 468
Pest management 464, 465
Pike and Sulkin 1, 2
Plague 190, 207, 211
Plasmodium spp. 223, 224, 226
Poliovirus 265, 266, 267, 287, 404, 547, 548, 549
Pontiac fever 169
Poxviruses 268, 288
Primary barriers 24
Primates 70, 144, 283, 455, 456
Pseudomonas 196, 404, 447, 448
 pseudomallei 156, 157, 195, 196, 447

Q

Q fever 239, 240, 244, 245

R

Rabies virus 271, 273
Radiological Hazards 378
Regulations 23, 70, 131, 143, 240, 244, 400, 408, 415, 416, 417, 418, 419, 421, 433, 438, 526, 542, 545
Respirator 548, 556
Retroviruses 273, 274, 289, 331
Rickettsia 241, 242, 244, 245, 246, 448
 akari 241
 australis 241
 bellii 243
 canadensis 167, 168, 243
 conorii 241
 montanensis 243
 prowazekii 241, 244, 448
 rhipicephali 243
 rickettsii 241, 242, 243, 244, 246, 448
 sibirica 241

spotted fever group 242
typhi 241, 448
Rickettsial Agents 239
Rift Valley fever virus 333
Risk assessment 1, 9, 16, 19, 20, 141, 237, 468, 515, 529
Rocky Mountain spotted fever 241

S

Safety equipment 16, 24
Salmonella 1, 2, 28, 179, 180, 181, 207, 208, 404, 448, 501
 S. enterica serotype Typhi 179, 181
SALS 292, 293, 295, 297, 298, 301, 307, 549
SARS-associated coronavirus 277
 SARS-CoV 276, 277, 278, 279, 280, 549
Schistosoma spp. 232, 233
Secondary barriers 29, 30
Select agents 408
Serum 134, 248, 346
Severe Acute Respiratory Syndrome 276, 290, 291, 549
 SARS 276, 277, 278, 279, 280, 290, 291, 452, 467, 549
Sharps 297, 301, 410
Sheep and Goat Pox Virus 550
 SGPV 550
Shiga toxin 182, 183, 454, 479, 480, 482, 503
Shigella spp. 2, 183, 184, 185, 448
Shigellosis 184
Shipment 8, 331
Simian immunodeficiency virus 132, 289
 SIV 132, 273, 274, 275, 276, 467, 550
Smallpox 269, 288
Sporothrix schenckii 216, 222
Spring viremia of carp virus
 SVCV 550
Standard Precautions 276, 279, 290, 291, 358, 359, 531, 541

Staphylococcal Enterotoxins 337, 349, 549
SE 204, 207, 337, 338, 339, 340, 350, 479, 549, 550
Sterilization 335, 359, 401, 403, 407, 410, 411, 412, 413, 550
Strongyloides spp 234, 235
Surveillance 145, 175, 206, 243, 273, 288, 365
Swine vesicular disease virus
SVDV 550
Syphilis 187, 210

T

Taenia solium 230
Tetanus 152, 163, 164, 200, 545
Theileria 451
annulata 451
bovis 173, 174, 175, 204, 205, 402, 404, 448, 450
Toxin Agents 334
Toxoplasma 28, 223, 451
Training 18, 33, 38, 44, 53, 73, 80, 89, 100, 128, 254, 463, 471, 500, 524, 535
Transmissible spongiform encephalopathies 355
TSE 355, 356, 361, 413, 550
Trematode parasites
Fasciola 232, 450
Schistosoma 232, 233
Treponema pallidum 187, 210
Trichophyton 218, 404, 449
Trypanosoma
cruzi 223, 224, 225, 226, 227, 451, 452
evansi 452
vivax 224, 226, 452
Tuberculosis 204, 205, 548
Tularemia 166, 201
Typhoid fever 181, 208

U

Ultraviolet lamps
UV lamps 385

V

Vaccines 26, 134, 150, 152, 154, 155, 160, 164, 165, 167, 175, 179, 181, 182, 185, 187, 188, 189, 191, 192, 193, 194, 200, 208, 240, 243, 250, 251, 253, 258, 265, 296, 304, 306, 336, 340, 342, 347, 348

Vaccinia 268, 269, 288, 548

Variola 270

Venezuelan equine encephalomyelitis 294

Vibrio 188, 189, 210, 211, 449

cholerae 188, 189, 210, 211, 449

parahaemolyticus 188, 189, 211, 449

Accessibility Descriptions of Figures

Appendix A—Primary Containment for Biohazards

Figure 1. HEPA Filters

HEPA filter consisting of a square wooden frame that contains borosilicate filter media that is wrapped around supporting aluminum columns. [◀RETURN TO FIGURE](#)

Figure 2. The Class I BSC

Cut away side view of Class I BSC. Arrows show air flowing into the unit from the bottom front sash then through the plenum at the back of the unit, and then exiting the unit through a HEPA filter at the top of the unit. [◀RETURN TO FIGURE](#)

Figure 3. The Class II, Type A BSC

Cut away side view of Class II Type A BSC. Arrows show air flowing into the unit from the bottom front sash and then being pulled by a fan up through a plenum at the back of the unit. Upon exiting the fan, 30% of the air is exhausted through a HEPA filter at the top of the unit and 70% is driven through a separate HEPA filter and down onto the work surface of the cabinet. [◀RETURN TO FIGURE](#)

Figure 4. Canopy (thimble) unit for ducting a Class II, Type A BSC

Cut away side view of a thimble unit positioned over the exhaust port of a BSC. The thimble overlaps the exhaust port by 1 inch on each side. The thimble is in the shape of a pyramid, with the wide bottom positioned above the exhaust port of the BSC and the narrow top connecting to a pipe representing the building exhaust system. [◀RETURN TO FIGURE](#)

Figure 5a. The Class II, Type B1 BSC (classic design)

Cut away side view of a Class II Type B1 BSC. The unit has three HEPA filters positioned above the work surface, below the work surface, and at the exhaust port at the top of the unit. A fan is positioned at the bottom of the unit, below the HEPA filter under the work surface. Arrows show air flow into the unit through the front sash and then in two directions within the unit. One direction is down through the HEPA filter under the work surface and then up through a plenum to the top of the unit, where it is driven down through a second HEPA filter to the work surface. The second airflow direction is through the back of the work surface to a separate plenum, and then out through a HEPA filter at the exhaust port at the top of the unit. The unit is directly connected (no thimble) to the building exhaust system. [◀RETURN TO FIGURE](#)

Figure 5b. The Class II, Type B1 BSC (benchtop design)

Cut away side view of a Class II type B1 BSC designed to sit on a bench top. The unit has two HEPA filters, one positioned above the work surface and the second at the exhaust port at the top of the unit. A fan is positioned in the top

of the unit, above the HEPA filter that sits above the work surface. Arrows show air flow into the unit through the front sash, down under the work surface, and through a plenum which directs it to the fan, which drives us through a HEPA filter down to the work surface. The HEPA-filtered air then splits just above the work surface, with one portion returning to the fan through the original plenum and a second portion flowing through a separate plenum to the exhaust port, where it is exhausted through a HEPA filter. The unit is directly connected (no thimble) to the building exhaust system. [◀RETURN TO FIGURE](#)

Figure 6. The Class II, Type B2 BSC

Cut away side view of a Class II Type B2 BSC. Two HEPA filters are shown. One is positioned above the work surface and the second is positioned at the exhaust port at the top of the unit. A fan is located in the top of the unit, above the HEPA filter that is positioned above the work surface. Arrows show air being drawn into the unit through the top of the unit and front sash, and then directed under the work surface. Air is then pulled up through an exhaust plenum and HEPA filter at the exhaust port. The unit is directly connected (no thimble) to the building exhaust system. [◀RETURN TO FIGURE](#)

Figure 7a. The Class II, Type C1 BSC (not connected to building exhaust system)

Cut away side view of a Class II, Type C1 BSC. Two HEPA filters are shown, one positioned directly above the work surface and one located at the exhaust port on the top of the unit. Two fans are shown, one located directly above the HEPA filter that is located above the work surface, and one located directly below the HEPA filter that is located at the exhaust port at the top of the unit. Arrows show air flowing into the unit through the front sash, down under the work surface, and then up through a plenum to a space above the work surface, where it is driven by a fan down through a HEPA filter to the work surface. The HEPA-filtered air then splits slightly above the work surface and is either recirculated back through the original plenum, or is pulled into a separate exhaust plenum and is exhausted through the second HEPA filter. The unit is not connected to the building exhaust system. [◀RETURN TO FIGURE](#)

Figure 7b. The Class II, Type C1 BSC (connected to building exhaust system)

Cut away side view of a Class II, Type C1 BSC that is connected to the building exhaust system. Two HEPA filters are shown, one positioned directly above the work surface and one located at the exhaust port on the top of the unit. Two fans are shown, one located directly above the HEPA filter that is located above the work surface, and one located directly below the HEPA filter that is located at the exhaust port at the top of the unit. Arrows show air flowing into the unit through the front sash, down under the work surface, and then up through a plenum to a space above the work surface, where it is driven by a fan down through a HEPA filter to the work surface. The HEPA-filtered air then splits slightly above the work

surface and is either recirculated back through the original plenum, or is pulled into a separate exhaust plenum and is exhausted through the second HEPA filter. The BSC is connected to the building exhaust system by a thimble unit that overlaps the exhaust port and provides a 1-inch gap to that allows for room air to be drawn in to balance the building exhaust system. [◀RETURN TO FIGURE](#)

Figure 8. The Class III BSC

Front view and cut away side view of Class III BSC. The front view shows two sets of glove ports (four ports total) arranged in a line below a viewing window that spans the width of the cabinet. A double ended pass through box is attached to the left side of the cabinet to allow for the moving of materials into and out of the cabinet. Two HEPA filters are located on the top of the cabinet; one is located at the air intake port and the second is located at the exhaust port. The cabinet is direct connected to an exhaust duct that contains an additional HEPA filter, thus providing for double HEPA filtration of exhaust air. The cut away side view shows a human hand inside of the glove port holding an item inside of the cabinet. Two HEPA filters are located on the top of the cabinet; one is located at the air intake port and the second is located at the exhaust port. The cabinet is direct connected to an exhaust duct that contains an additional HEPA filter, thus providing for double HEPA filtration of exhaust air. [◀RETURN TO FIGURE](#)

Figure 9a. The Horizontal Laminar flow Clean Bench

Cut away side view of a horizontal laminar flow clean bench. There is a broad opening in the front of the unit and a HEPA filter located in the rear of the work area. There is a plenum between the HEPA filter and the back wall of the unit, and a fan located in the bottom of the unit. Airflow arrows show air entering the unit from a port on the front and beneath the work surface. The fan drives the incoming air up the plenum, through the HEPA filter, and across the work surface. The HEPA filtered air then exits the unit out the front opening and toward the worker. [◀RETURN TO FIGURE](#)

Figure 9b. The Vertical Laminar Flow Clean Bench

Cut away side view of a vertical laminar flow clean bench. The unit contains a HEPA filter located above the work surface and a fan in the space above the HEPA filter. Airflow arrows show air entering the unit through a port in the top of the unit, and then being driven by the fan down through the HEPA filter and on to the work surface. The HEPA filtered air then exits the unit through the front opening toward the worker. [◀RETURN TO FIGURE](#)

Figure 10. Clean to Dirty

Front view of a BSC that contains equipment and materials typically used in biological manipulations. The equipment in the BSC is oriented for use by a right-handed worker. “Clean” materials, such as sterile culture media or buffer

containers are located on the left side of the work surface. “Dirty” materials such as waste containers are located on the right side of the work surface. This order would be reversed if the worker was left-handed. [◀RETURN TO FIGURE](#)

Figure 11. Protection of a house vacuum

Two vacuum flasks and an in-line HEPA filter are connected in series by vacuum lines to a port for house vacuum. Material is drawn into the first flask, which contains a decontamination solution. The first flask is connected by a vacuum line to a second empty flask, which provides overflow protection for the first flask. An in-line HEPA filter is located between the overflow flask and the house vacuum port.

[◀RETURN TO FIGURE](#)

Figure 12. Bag-in/bag-out filter enclosure

Exploded view of a large square HEPA housing unit that contains two HEPA filter assemblies one stacked on the other. The Upper filter assembly is exploded out to show the filter unit, removal bag, support straps, and housing lid are arranged to allow for removal of a contaminated filter using the pre-packed bag already present in the housing. The lower filter assembly is shown only with the housing lid removed to illustrate how the filter and removal bag are packed into the housing.

[◀RETURN TO FIGURE](#)

Appendix C—Transportation of Infectious Substances

Figure 1. A Category A UN Standard Triple Packaging

Complete Category A packaging system, including the outer cardboard container with required labels and a hard walled cylindrical secondary container with a screw cap. The secondary container contains the sealable primary container for the biological material, which may be glass, metal, or plastic, along with absorbent material to capture any leakage within the secondary container.

[◀RETURN TO FIGURE](#)

Figure 2. A Category B Non-specification Triple Packaging

Complete Category B packaging system, including the outer cardboard container with required labels, and a leak-proof secondary container, such as a sealable plastic bag. The secondary container contains the sealable primary container for the biological material, which may be glass, metal, or plastic, along with absorbent material to capture any leakage within the secondary container.

[◀RETURN TO FIGURE](#)



U.S. Department of Health and Human Services
Public Health Service
Centers for Disease Control and Prevention
National Institutes of Health

HHS Publication No. (CDC) 300859

Revised June 2020

CS308133-A